

Table of Contents

1. Introduction	7
Step 1 - Introduction	8
Step 2 - Printer compatibility	8
Step 3 - Tools included for the Enclosure assembly	9
Step 4 - Additional tools	9
Step 5 - Labels guide	10
Step 6 - Use labels for reference	10
Step 7 - View high resolution images	11
Step 8 - Reward yourself	11
Step 9 - How to successfully finish the assembly	12
Step 10 - Upgrade your parts	13
Step 11 - Optional parts	14
Step 12 - Add-ons	14
Step 13 - We are here for you!	15
2. Assembling the Enclosure	16
Step 1 - Tools necessary for this chapter	17
Step 2 - Base & feet: parts preparation	17
Step 3 - Preparing the foot-brackets	18
Step 4 - Attaching the anti-vibration pads	18
Step 5 - Attaching the foot-brackets	19
Step 6 - Mounting the foot-brackets	19
Step 7 - Anti-slip dampers: parts preparation	20
Step 8 - Preparing the anti-slip dampers	20
Step 9 - Mounting the anti-slip dampers	21
Step 10 - Profiles: parts preparation	21
Step 11 - Installing the profiles	22
Step 12 - Top panel: parts preparation	22
Step 13 - Fire Suppression System (add-on): parts preparation	23
Step 14 - Preparing the Fire suppression system tube (add-on)	23
Step 15 - Attaching the Fire suppression system tube (add-on)	24
Step 16 - Securing the Fire suppression system tube (add-on): right side	24
Step 17 - Securing the Fire suppression system tube (add-on): left side	25
Step 18 - Installing the top panel	25
Step 19 - Preparing the top window panel	26
Step 20 - Mounting the top window panel	26
Step 21 - MINI Back panel: parts preparation	27
Step 22 - Installing the back panel	27
Step 23 - Advanced filtration system (add-on): parts preparation	28
Step 24 - Assembling the filtration: parts preparation (add-on)	28
Step 25 - Assembling the filtration (add-on)	29
Step 26 - Assembling the filtration (add-on)	29
Step 27 - Assembling the filtration (add-on)	30
Step 28 - Installing the blower (add-on)	30
Step 29 - Inserting the HEPA filter (add-on)	31
Step 30 - Inserting the HEPA filter (add-on)	31
Step 31 - Installing the filtration (add-on)	32
Step 32 - Side panels: parts preparation	32
Step 33 - Installing the side panel	33
Step 34 - Transport handle (optional): parts preparation	33
Step 35 - Installing the transport handle (optional)	34

Step 36 - Mounting the transport handle (optional)	34
Step 37 - White LED strip (add-on): parts preparation	35
Step 38 - Assembling the LED strip (add-on)	35
Step 39 - Assembling the LED strip (add-on)	36
Step 40 - Mounting the LED strip (add-on)	36
Step 41 - LED cable: parts preparation (add-on)	37
Step 42 - Guiding the LED cable (add-on)	37
Step 43 - Guiding the filtration cable: parts preparation (add-on)	38
Step 44 - Guiding the add-on cables: filtration cable (add-on)	38
Step 45 - USB cable: parts preparation	39
Step 46 - Inserting the USB cable	39
Step 47 - PSU: parts preparation (add-on)	40
Step 48 - Guiding the PSU cable (add-on)	40
Step 49 - Releasing the front foot (add-on)	41
Step 50 - Securing the PSU cable (add-on)	41
Step 51 - Printer PSU preparing	42
Step 52 - Inserting the printer PSU cable	42
Step 53 - Securing the printer PSU cable	43
Step 54 - Basic Board: parts preparation (add-on)	43
Step 55 - Installing the Basic Board (add-on)	44
Step 56 - Installing the Basic Board (add-on)	44
Step 57 - Assembling the Basic Board (add-on)	45
Step 58 - Mounting the Basic Board (add-on)	45
Step 59 - Connecting the Basic Board (add-on)	46
Step 60 - PSU holder clarification (optional)	46
Step 61 - PSU holder: parts preparation (optional)	47
Step 62 - PSU holder nut preparation (optional)	47
Step 63 - PSU holder preparation (optional)	48
Step 64 - Attaching the PSU holder (optional)	48
Step 65 - Securing the PSUs (optional)	49
Step 66 - Door hinges: parts preparation	49
Step 67 - Assembling the hinges	50
Step 68 - Mounting the hinges	50
Step 69 - Mechanical lock (add-on): parts preparation	51
Step 70 - Assembling the lock insert (add-on): parts preparation	51
Step 71 - Assembling the lock housing (add-on)	52
Step 72 - Securing the lock housing (add-on)	52
Step 73 - Assembling the lock mechanism (add-on): parts preparation	53
Step 74 - Assembling the lock mechanism (add-on)	53
Step 75 - Securing the lock mechanism (add-on)	54
Step 76 - Installing the door panel (add-on): parts preparation	54
Step 77 - Installing the door panel (add-on)	55
Step 78 - Door assembly: parts preparation	55
Step 79 - Installing the door panel	56
Step 80 - Assembling the door handle	56
Step 81 - Haribo time!	57
Step 82 - Good job!	57
3. Installing the printer	58
Step 1 - Tools necessary for this chapter	59
Step 2 - Setting up the printer	59
Step 3 - Removing the input PTFE tube (optional)	60
Step 4 - Removing the filament sensor (optional)	60
Step 5 - Input PTFE tube: parts preparation (optional)	61
Step 6 - Inserting the PTFE tube	61

Step 7 - Filament sensor installation (optional)	62
Step 8 - Preparing the printer	62
Step 9 - Installing the printer	63
Step 10 - Connecting the PSUs: parts preparation (add-on)	63
Step 11 - Connecting the PSUs (add-on)	64
Step 12 - Connecting the cables	64
Step 13 - Adjusting printer position	65
Step 14 - Thermometer: parts preparation	65
Step 15 - Assembling the thermometer	66
Step 16 - Spool holder: parts preparation	66
Step 17 - Installing spool holder	67
Step 18 - Mounting the side arm	67
Step 19 - Sticking the label	68
Step 20 - Haribo time!	68
Step 21 - That's it	69
Advanced filtration system (add-on)	70
Step 1 - Tools necessary for this chapter	71
Step 2 - Additional tools	71
Step 3 - Optional parts	72
Step 4 - Removing the side arm	72
Step 5 - Disconnecting the cables	73
Step 6 - Uninstalling the printer	74
Step 7 - Advanced filtration system: parts preparation	74
Step 8 - Assembling the filtration: parts preparation	75
Step 9 - Assembling the filtration	75
Step 10 - Assembling the filtration	76
Step 11 - Assembling the filtration	76
Step 12 - Installing the blower	77
Step 13 - Inserting the HEPA filter	77
Step 14 - Inserting the HEPA filter	78
Step 15 - Installing the filtration	78
Step 16 - Guiding the filtration cable: parts preparation	79
Step 17 - Guiding the add-on cables: filtration cable	79
Step 18 - PSU: parts preparation	80
Step 19 - Releasing the rear foot	80
Step 20 - Guiding the PSU cable	81
Step 21 - Securing the rear foot	81
Step 22 - Releasing the front foot	82
Step 23 - Securing the PSU cable	82
Step 24 - Basic Board: parts preparation	83
Step 25 - Installing the Basic Board	83
Step 26 - Installing the Basic Board	84
Step 27 - Mounting the Basic Board	84
Step 28 - Connecting the Basic Board	85
Step 29 - PSU holder clarification (optional)	85
Step 30 - PSU holder: parts preparation (optional)	86
Step 31 - PSU holder nut preparation (optional)	86
Step 32 - PSU holder preparation (optional)	87
Step 33 - Attaching the PSU holder (optional)	87
Step 34 - Securing the PSUs (optional)	88
Step 35 - Installing the printer	88
Step 36 - Adjusting printer position	89
Step 37 - Connecting the cables	89
Step 38 - Mounting the side arm	90

Step 39 - Connecting the cables	90
Step 40 - Connecting the PSUs: parts preparation	91
Step 41 - Connecting the PSUs	91
Step 42 - That's it	92
White LED strip (add-on)	93
Step 1 - Tools necessary for this chapter	94
Step 2 - Additional tools	94
Step 3 - Optional parts	95
Step 4 - Removing the side arm	95
Step 5 - Disconnecting the cables	96
Step 6 - Uninstalling the printer	97
Step 7 - Delta PSU: parts preparation	97
Step 8 - Releasing the rear foot	98
Step 9 - Guiding the PSU cable	98
Step 10 - Securing the rear foot	99
Step 11 - Releasing the front foot	99
Step 12 - Securing the PSU cable	100
Step 13 - White LED strip: parts preparation	100
Step 14 - Assembling the LED strip	101
Step 15 - Assembling the LED strip	101
Step 16 - Mounting the LED strip	102
Step 17 - LED cable: parts preparation	102
Step 18 - Guiding the LED cable	103
Step 19 - Basic Board: parts preparation	103
Step 20 - Installing the Basic Board	104
Step 21 - Installing the Basic Board	104
Step 22 - Mounting the Basic Board	105
Step 23 - Connecting the Basic Board	105
Step 24 - PSU holder clarification (optional)	106
Step 25 - PSU holder: parts preparation (optional)	106
Step 26 - PSU holder nut preparation (optional)	107
Step 27 - PSU holder preparation (optional)	107
Step 28 - Attaching the PSU holder (optional)	108
Step 29 - Securing the PSUs (optional)	108
Step 30 - Installing the printer	109
Step 31 - Adjusting printer position	109
Step 32 - Connecting the cables	110
Step 33 - Mounting the side arm	110
Step 34 - That's it	111
Fire Suppression System (add-on)	112
Step 1 - Tools necessary for this chapter	113
Step 2 - Removing the side arm	113
Step 3 - Disconnecting the cables	114
Step 4 - Uninstalling the printer	115
Step 5 - Fire suppression system: parts preparation	115
Step 6 - Mounting the P-clamp	116
Step 7 - Mounting the P-clamp	116
Step 8 - Installing the automatic suppression system	117
Step 9 - Securing the automatic suppression system	117
Step 10 - Installing the printer	118
Step 11 - Adjusting printer position	118
Step 12 - Connecting the cables	119
Step 13 - Mounting the side arm	119
Step 14 - Connecting the cables	120

Step 15 - That's it	120
Mechanical lock (add-on)	121
Step 1 - Introduction	122
Step 2 - Tools necessary for this chapter	122
Step 3 - Additional tools	123
Step 4 - Disassembling the door handle	123
Step 5 - Mechanical lock: parts preparation	124
Step 6 - Assembling the lock housing	124
Step 7 - Securing the lock housing	125
Step 8 - Assembling the lock mechanism: parts preparation	125
Step 9 - Assembling the lock mechanism	126
Step 10 - Securing the lock mechanism	126
Step 11 - Good job!	127
Manual changelog MINI Enclosure	128

1. Introduction

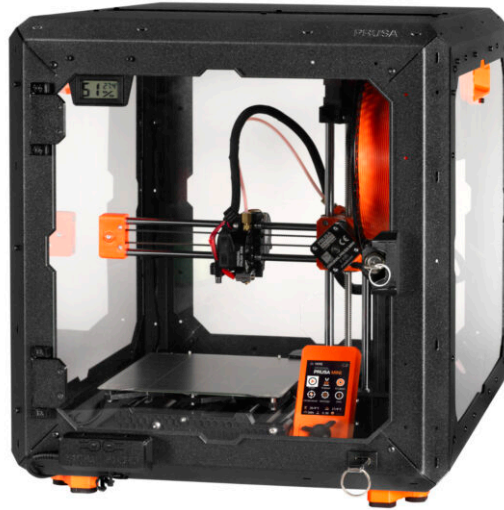

STEP 1 Introduction



- ◆ Welcome to the assembly instructions for the **Original Prusa MINI Enclosure**.
- ⓘ In this chapter, you will learn all the important information needed for the assembly. Please read carefully.
- ⚠ **Important notice:** the package contains metal sheet profiles that have sharp edges. Handle the parts very carefully.
- ⚠ **If children are involved in assembly, always supervise them to avoid injury.**

STEP 2 Printer compatibility



- ⓘ The MINI Enclosure assembly manual is specifically intended for these devices:
 - ◆ Original Prusa MINI+
 - ◆ Original Prusa MINI

STEP 3 Tools included for the Enclosure assembly

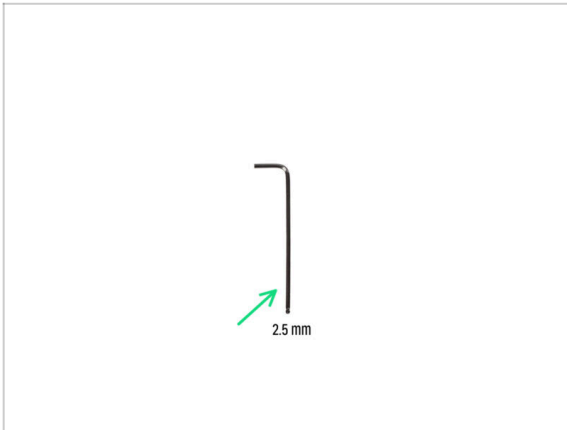

- **The kit includes:**
- 2.5mm Allen key

STEP 4 Additional tools

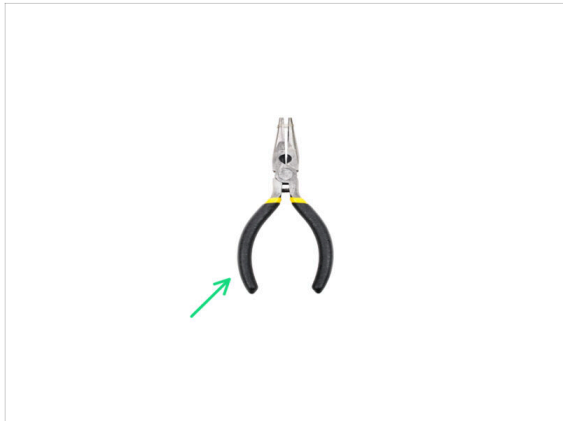

i Tools that are not included but can make assembly easier, especially when installing add-ons.

● **Additional tools:**

- Side cutters for cutting zip ties and side panels cutouts
- Pliers for securing the E-clip washer

STEP 7 View high resolution images

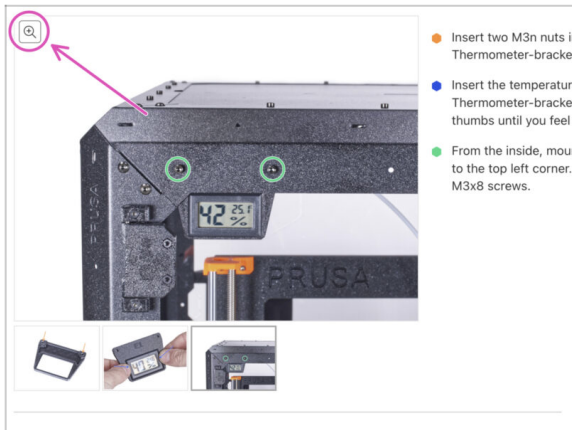

i When you browse the guide on help.prusa3d.com, you can view the original images in high resolution for clarity.

Just hover your cursor over the image and click the Magnifier button ("View original") in the top left corner.

STEP 8 Reward yourself



From the experience of building Original Prusa printers, we know that Haribo Bears are an integral and important part of every kit. Although it's not entirely about building a printer now, we've got your safety in mind, and added some amount of gummy bears to your kit as well.

! **Do not eat the whole bag right at the beginning of the assembly! It is VERY IMPORTANT to distribute the amount correctly during assembly. We tried all sorts of combinations of quantities. Finally, we reached a successful result.**

Open the package and arrange the gummy bears according to the picture. **Don't eat anything now!** Always wait for instructions.

i **Your package might contain fewer bears.** In such a case, run immediately to the nearest candy store! **The exact dosage is absolutely critical!!!**

Eat the first gummy bear to boost your energy. Really, just one!

STEP 9 How to successfully finish the assembly

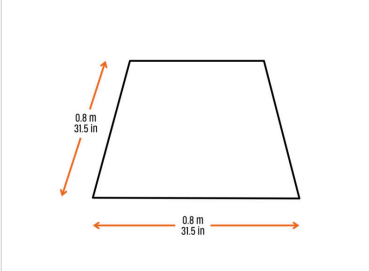

Step 16 X-carriage assembly



⚠️ For the following nut insertion **USE A SCREW THAT'S AN ODD LENGTH!** **Seriously, use a screw to pull the nuts in, both have to be properly seated in the X-carriage.**

- Take both side nuts and using pliers for screws push them in the X-carriage, then using a screw from the other side, pull them all the way in.
- Don't forget to remove the screw.
- Take all four M3x6 nuts and insert them in. Ensure correct alignment using the Allen key.
- From now on, keep in mind the nuts are inside, avoid rotating the X-carriage "downwards", or the nuts might fall out.

48 comments

Step 3 Placing the Z-screw covers

- For the following steps, please prepare:
 - Z-axis motor (2x)
- Note each Z-axis motor has different cable length. The shorter one must be on the left side, longer on the right side.
- Z-screw cover (2x)
- Remove the frictional nuts from the motor, **DON'T THROW** them away, you will need them!
- Screw the Z-screw covers onto both lead screws.
- Covers should be screwed fully to the motor, but not too tight! The motor must be able to spin freely!

48 comments

It's easy on this step to overlook the addition of the Z screw covers. The names are a bit generic. It would help if the screw covers were orange instead of black (or just not black) so they stand out in the pictures and can be seen as distinct from the trapezoidal nuts.

David L. Lambert



For a better handling, it is recommended to **prepare a clean workbench with a space of at least 0.8 m x 0.8 m (31.5 in x 31.5 in)**. With access from two sides or more.



We're recommending a **bright light above your workbench**. Some parts inside the enclosure are dark and inadequate light could make a very difficult procedure.



Always read all the instructions at the current step first. This will help you to understand, what you need to do. **Don't cut or trim unless you are told to!!!**



Don't follow pictures only! It is not enough, the written instructions are as brief as they can be. Read them.



Read the comments from the other users. They are a great source of ideas. We read them too and based on your feedback improve the manual and the entire assembly.



Use a reasonable force. The printed parts are tough, but not unbreakable. If it doesn't fit, check your approach twice.



Most important: Enjoy the build, have fun. *Cooperate with your kids, friends or partners. However, we take no responsibility for possible fights ;)*

STEP 10 Upgrade your parts

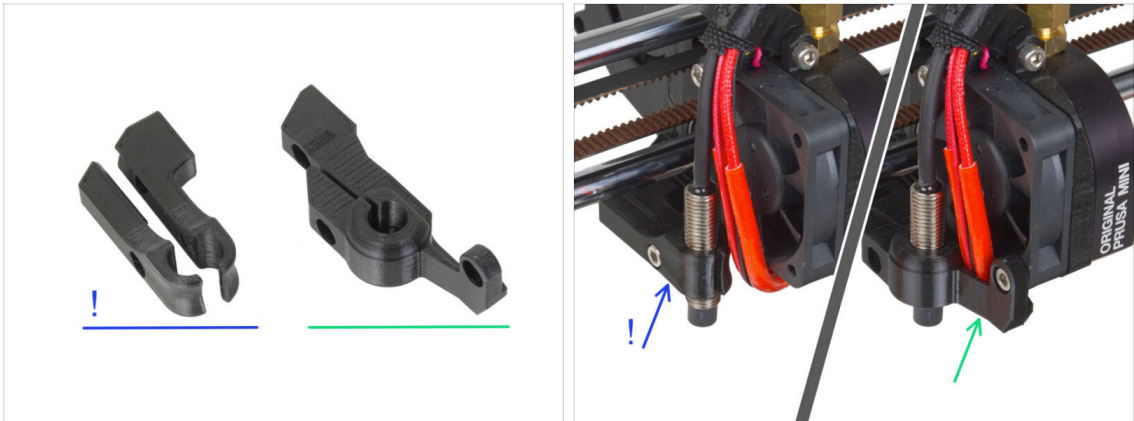

- ⓘ Certain parts of your printer may be more susceptible to the higher temperatures that can occur inside the enclosure during printing. We recommend upgrading these parts to more durable ones:
- **Old MINI-minda-holder:** on the first Original Prusa MINI units. Assembled from two parts. If you have this version, **it is recommended to upgrade to the new one**, which is available for download on [Printables](#).
 - Instructions for replacing the part can be found in the [separate guide](#).
 - ⚠ **The replacement changes the height of the SuperPINDA/M.I.N.D.A. sensor! Don't forget to recalibrate the first layer after replacing these parts.**
 - **New MINI-minda-holder:** sturdy part, attached to the fan case. If you have this part, you do not need to upgrade it.
- ⚠ **Print out all required parts before proceeding with the instructions.**

STEP 11 Optional parts



- We have designed enhancements that are not shipped by default in the kit, but you can print them out and add them to the enclosure during assembly. Fasteners are already included in the kit.

⚠ **Print out the parts before you start assembly.**

- To see the full list of the parts, please visit our collection at [Printables.com](https://www.printables.com).

STEP 12 Add-ons



📌 Have you purchased any add-ons along with the MINI Enclosure? Instructions for installing them are included in the manual, and you will be informed in advance for each add-on.

- At the beginning of the instructions for each add-on, you will be reminded of the add-on symbol.

📄 If you don't have any add-ons, you can skip the steps related to add-ons and proceed with the other necessary instructions.

STEP 13 We are here for you!

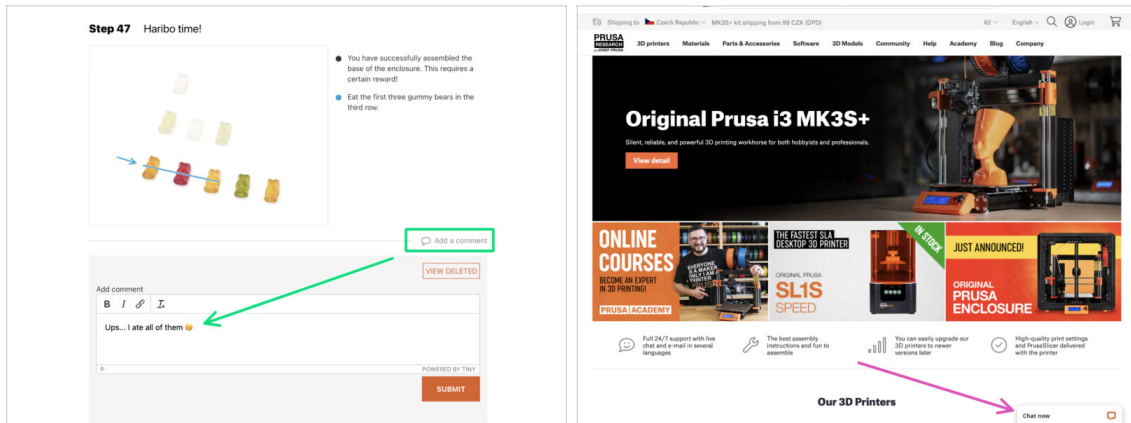

- Lost in the instructions? Missing screw or cracked printed part? **Let us know!**
- You can contact us using following channels:
 - Using comments under each step.
 - Using our 24/7 live chat at prusa3d.com
 - Writing an email to info@prusa3d.com
- So, ready? Let's move to the next chapter **2. Assembling the Enclosure.**

2. Assembling the Enclosure

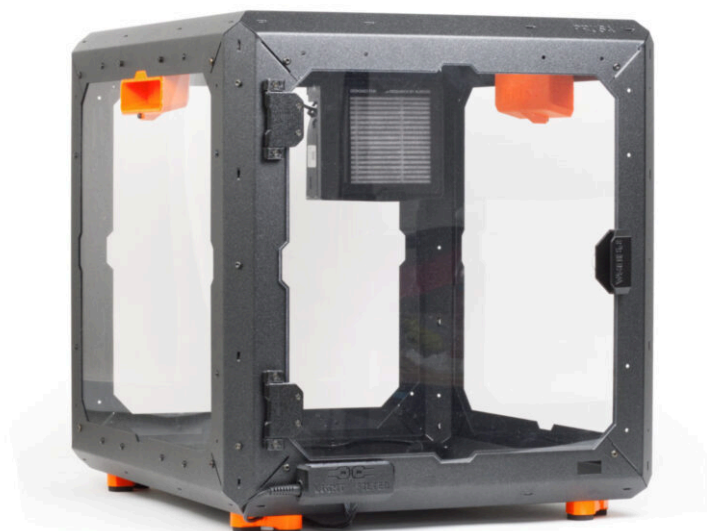

STEP 1 Tools necessary for this chapter

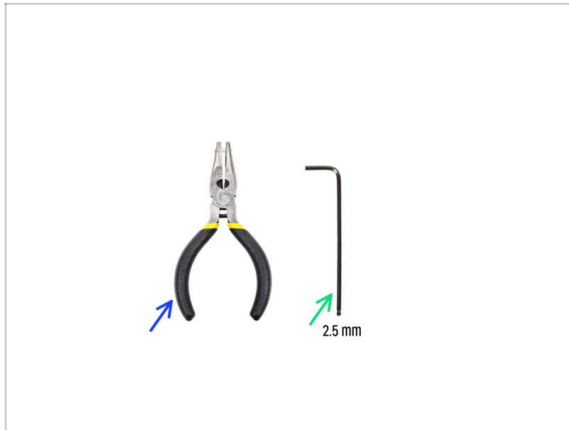

- For this chapter, please prepare:
- Needle-nose pliers *for mechanical lock add-on only*
- 2.5mm Allen key

STEP 2 Base & feet: parts preparation

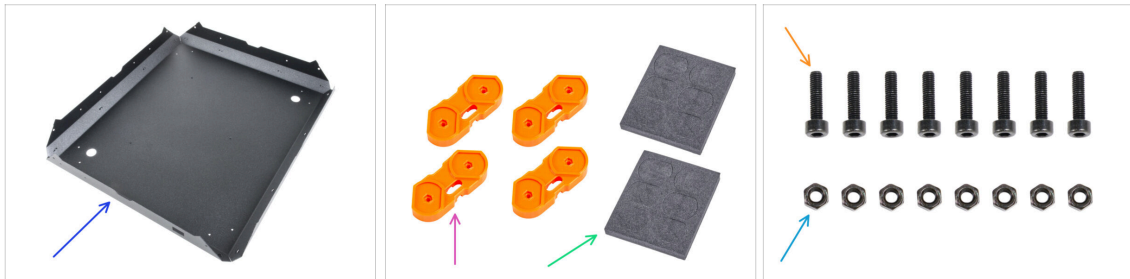

- For the following steps, please prepare:
- MINI Bottom panel (1x)
 - ⚠ **Handle metal sheet very carefully! The metal sheet have sharp edges.**
- Feet bracket (4x)
- Foam block or foam pad set (2x)
- M3x12 screw (8x)
- M3n nut (8x)

STEP 3 Preparing the foot-brackets



◆ Into each foot-bracket, insert two M3n nuts.

⚠ **Do not flip the part over. The nuts may fall off the part.**

STEP 4 Attaching the anti-vibration pads



◆ Gently push 8 pads out of the blocks.

ⓘ Keep the remaining four pads as a spare.

◆ Peel the protective film from all pads. Be careful, there is glue (adhesive) applied on the pad.

⚠ **Take the foot-bracket and check both M3 nuts are in place before you glue the anti-vibration pads.**

◆ Glue the anti-vibration pad into each same-shape pocket in the foot-brackets. Always apply pressure to the pad to ensure proper adhesion.

STEP 5 Attaching the foot-brackets

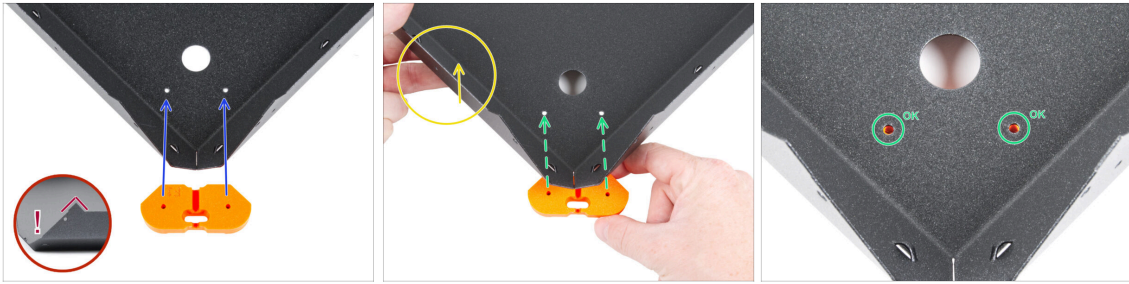

- ⚠️ Take the MINI Bottom panel and ensure its correct orientation. **The sharp bends of the sheet metal must point upwards.**
- ⬛ We recommend using a soft, clean pad when working with sheet metal parts to protect both the part and your workbench.
- 🔵 Take the foot-bracket and align it with the two holes in the MINI Bottom panel as shown.
- ⚠️ **Ensure the same part orientation as seen in the picture.**
- 🟡 Slightly lift the MINI Bottom panel.
- 🟢 Slide the foot-bracket under the MINI Bottom panel until the holes in the base align with the holes in the foot-bracket.
- ⚠️ Do not move with the assembly.

STEP 6 Mounting the foot-brackets



- ⚠️ Do not move with the assembly.
- ⬛ Again, check the holes in both parts are lined up.
- 🔵 Insert two M3x12 screw into the holes.
- 🟢 Fully tighten both screws.
- 🟡 Proceed the same with all foot-brackets.

STEP 7 Anti-slip dampers: parts preparation



◆ For the following steps, please prepare:

- ◆ Anti-slip damper (3x)
- ◆ Damper-insert (3x)
- ◆ M3x20 screw (3x)

STEP 8 Preparing the anti-slip dampers



- ◆ Push the damper-insert into the anti-slip damper. No matter which side, the anti-slip damper is symmetrical.
- ◆ Turn the assembly on its feet and orient the MINI Bottom panel with the rectangular cutout facing to the front.
- ⓘ Remember that this cutout will mark the front of the enclosure during assembly.
- ◆ Locate three threaded holes on the left side of the bottom panel. We will use them in the next step.

STEP 9 Mounting the anti-slip dampers



- Place the anti-slip damper on the threaded hole.
- Insert the M3x20 screw into the anti-slip damper and tighten it.
- Proceed the same for other anti-slip dampers.

STEP 10 Profiles: parts preparation

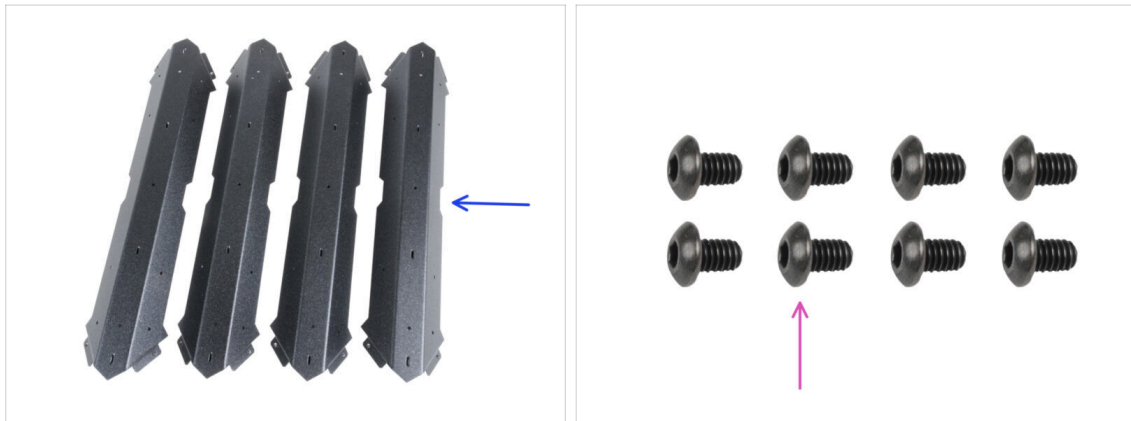

- For the following steps, please prepare:
- MINI Profile (4x)
 - M4x5r screw (8x)

STEP 11 Installing the profiles

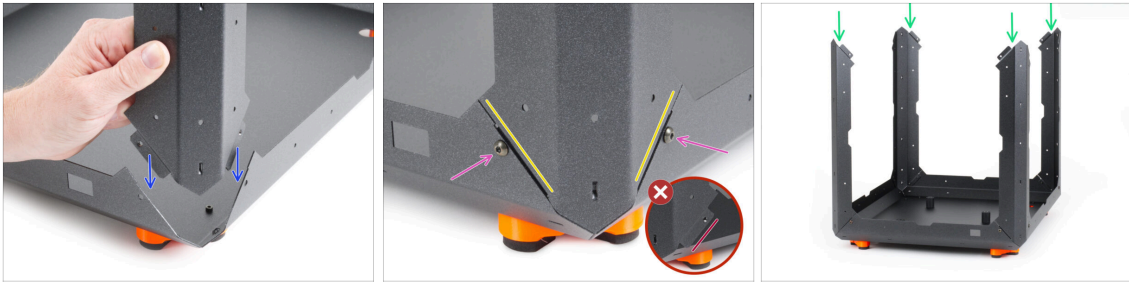

- Attach the MINI Profile to one of the MINI Bottom panel corner.
 - The bent perforations of the profile must fit into the inside of the base.
 - Make sure the profile fits perfectly into the base.
 - ⚠ **No perforations in the profile may protrude outwards.**
 - Join both parts together with two M4x5r screws. Tighten gently but firmly.
 - Use the same procedure for all profiles.

STEP 12 Top panel: parts preparation



- **For the following steps, please prepare:**
 - ⚠ **Handle metal sheet very carefully! The metal sheet have sharp edges.**
 - MINI Top panel (1x)
 - MINI Top window panel (1x)
 - Nylon rivet (6x)
 - M4x5r screw (8x)

STEP 13 Fire Suppression System (add-on): parts preparation



i NOTE: The following instructions are only for those who have purchased this optional add-on with the MINI Enclosure. If you have not purchased this add-on, please proceed to step [Installing the top panel](#).

For the following steps, please prepare:

Fire suppression system tube (1x) type: T033E BlazeCut T Series Fire Suppression 1 System with a pressure gauge

! Handle the tube carefully to avoid damage.

Fire suppression brackets (2x)

Thumb nut M3 (2x)

M3x12 screw (2x)

STEP 14 Preparing the Fire suppression system tube (add-on)

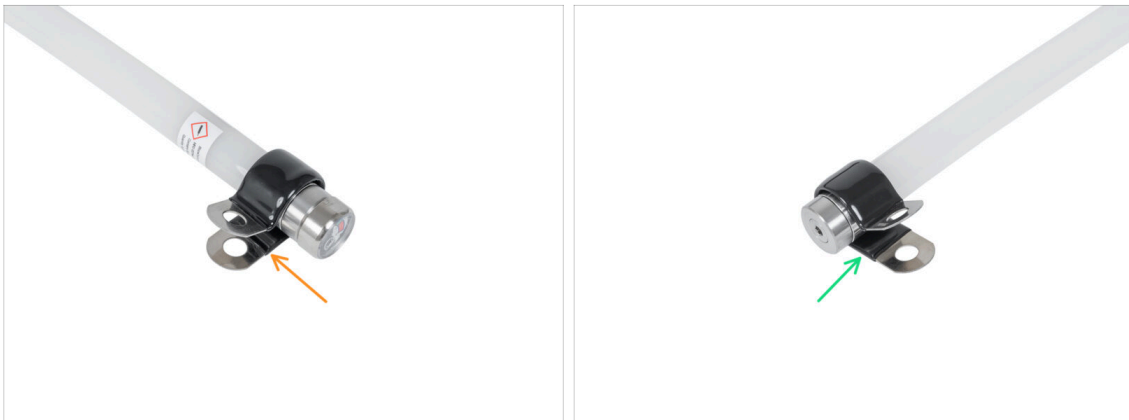

Attach the fire suppression bracket to one end of the tube. **Pay attention to the direction.**

Attach the fire suppression bracket to the second end of the tube. **Make sure it is in the same direction as the first one.**

STEP 15 Attaching the Fire suppression system tube (add-on)

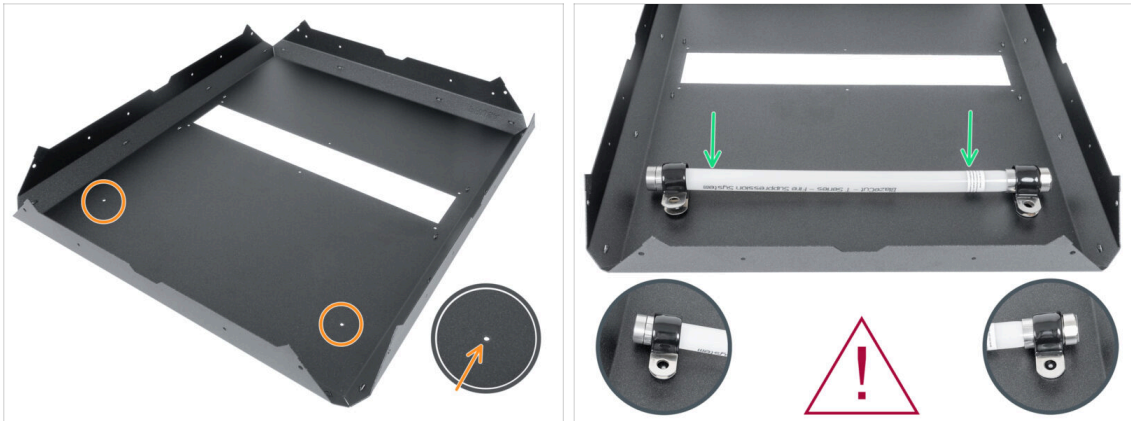

- 🟠 Locate two holes in the MINI Top panel.
- ⚠️ **Handle the tube carefully to avoid damage.**
- 🟢 Attach the prepared Fire suppression and align the bracket with the holes in the MINI Top panel. **Mind the orientation of the Fire suppression in the picture.**

STEP 16 Securing the Fire suppression system tube (add-on): right side



- ⬛ From the outside of the MINI Top panel:
- 🟠 Insert the M3x12 screw through the hole.
- ⬛ From the inside:
- 🟢 Secure the screw with the M3 thumb nut.

STEP 17 Securing the Fire suppression system tube (add-on): left side



- On the other side:
- From the outside of the MINI Top panel:
 - Insert the M3x12 screw through the hole.
- From the inside:
 - Secure the screw with the M3 thumb nut.
- Well done! The Fire suppression add-on is installed.

STEP 18 Installing the top panel



- Carefully place the MINI Top panel on the profiles, ensuring it is supported by all profiles.
 - ⚠ **Ensure the correct orientation! The PRUSA logo and the rectangular cutout must face the same direction.**
- Check each support to ensure that the MINI Top panel is properly bearing down on it.
- Secure each profile with the MINI Top panel using two M4x5r screws.

STEP 19 Preparing the top window panel



- ◆ Carefully peel off the protective layers from both sides of the MINI Top window panel.

⚠ **Be careful; the panel is very susceptible to scratches.**

STEP 20 Mounting the top window panel

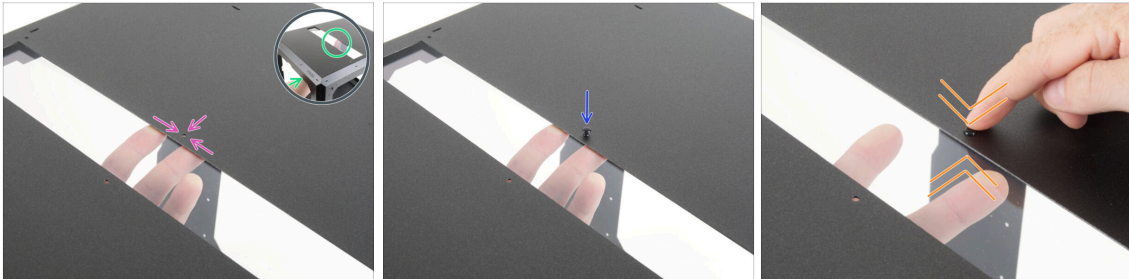

In this step, you will learn how to secure the panels with the nylon rivets. Remember this method, as you will use it throughout the assembly.

- ◆ From the inside, carefully place the MINI Top window panel over the rectangular opening in the MINI Top panel.
- ◆ Align the holes of both parts.
- ◆ Insert the nylon rivet through the holes of both parts.
- ◆ Push on the nylon rivet to secure the window panel in the frame. When pressing on the nylon rivet, apply light pressure on the opposite side, specifically on the MINI Top window panel around the rivet.
- ◆ Repeat this procedure for the remaining holes in the opening.

STEP 21 MINI Back panel: parts preparation



● For the following steps, please prepare:

● MINI Back panel (1x) with the octagonal cutout

● Nylon rivet (8x)

ⓘ If you are going to install the **Advanced filtration system** optional add-on, you will only need 6pcs.

STEP 22 Installing the back panel



● Turn the Enclosure sideways so that the rear side (without the PRUSA logo) is facing you.

● Peel off the protective layers from both sides of the MINI Back panel.

⚠ **Be careful; the panel is very susceptible to scratches.**

● From the inside, carefully place the MINI Back panel to the rear Enclosure "frame".

⚠ **Mind the correct orientation of the panel. The octagonal cutout must be at the bottom.**

● Align the holes of the panel and the Enclosure "frame" and secure it with one nylon rivet near the top right corner. When pressing on the nylon rivet, apply light pressure on the opposite side, specifically on the MINI Back panel around the rivet.

● In this way, secure the panel around the entire perimeter.





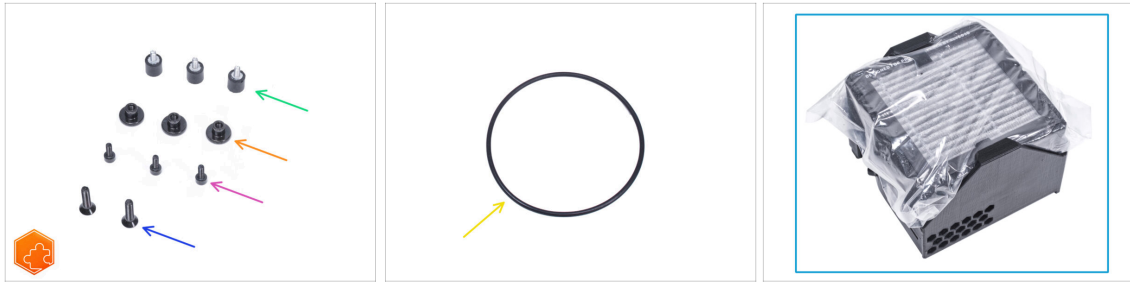

● **If you are going to install the Advanced filtration system** optional add-on, leave the marked holes empty.

STEP 23 Advanced filtration system (add-on): parts preparation



NOTE: The following instructions are only for those who have purchased this optional add-on with the MINI Enclosure. If you have not purchased this add-on, please proceed to step [Side panels: parts preparation](#)



For the following steps, please prepare:

-  Damper (3x)
-  Thumb nut M3 (3x)
-  M3x8 screw (3x)
-  M4x16b countersunk screw (2x)
-  Blower o-ring (1x)
-  Filtration pack (1x)

STEP 24 Assembling the filtration: parts preparation (add-on)



Push out the filter from the filtration pack and **divide the pack into these individual parts:**

-  High Pressure Blower (1x)
-  HEPA filter (1x)
-  Filter-Bracket (1x)

STEP 25 Assembling the filtration (add-on)



- ✦ Place the Filter-Bracket like in the picture and push the Allen key through the hole as you can see.
- ✦ Attach the M3x8 screw on the tip of the Allen key.
- ✦ Using the Allen key, push the screw all the way through the front hole of the bracket. The screw must protrude partially.

STEP 26 Assembling the filtration (add-on)



- ✦ Tighten the damper on the screw.
- ✦ Repeat the same procedure to install the second damper.

STEP 27 Assembling the filtration (add-on)

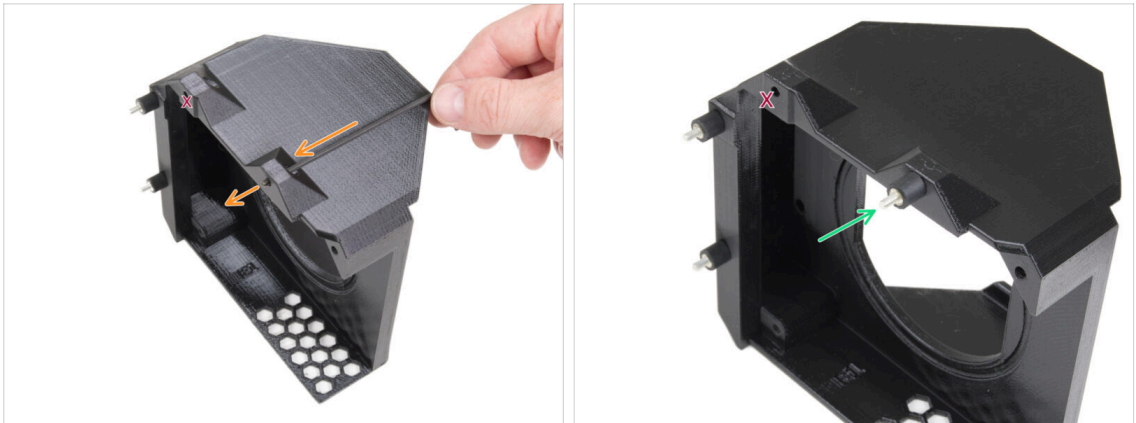

- 🟠 Using the Allen key, push the M3x8 screw through the protrusion on the other side of the Filter-Bracket.
- ⚠️ Leave the marked hole empty.
- 🟢 Tighten the damper on the screw.

STEP 28 Installing the blower (add-on)



- 🟠 Place the Blower o-ring into the Filter-Bracket.
- 🟢 Insert the High Pressure Blower into the Filter-Bracket so that the blower of the fan faces the hexagonal holes in the printed part.
- 🟡 Join both parts together with two M4x16b countersunk screws.

STEP 29 Inserting the HEPA filter (add-on)



◆ Tear open the filter bag and remove the HEPA filter.

⚠ **Handle the filter with caution.** If the HEPA surface (the white pleated surface) is damaged, the filter will lose its efficiency. Protect your hands when you take off the used filter and put it in a plastic bag. A saturated filter is not recyclable.

STEP 30 Inserting the HEPA filter (add-on)



◆ Orient the filtration assembly according to the picture. Make sure that two brackets are facing you and the cable is pointing to the left.

⚠ **Make sure that the HEPA filter is already removed from the bag.**

◆ From the left, push the HEPA filter all the way into the Filter-Bracket. Mind the orientation of the filter.

STEP 31 Installing the filtration (add-on)



- ◆ From the inside, attach the filtration to the rear side of the Enclosure "frame" so that all three screws go through the holes.
- ◆ Secure all three damper screws by tightening three thumb nuts.
- ◆ Leave the filtration fan cable free for now. We will plug it later on.

STEP 32 Side panels: parts preparation

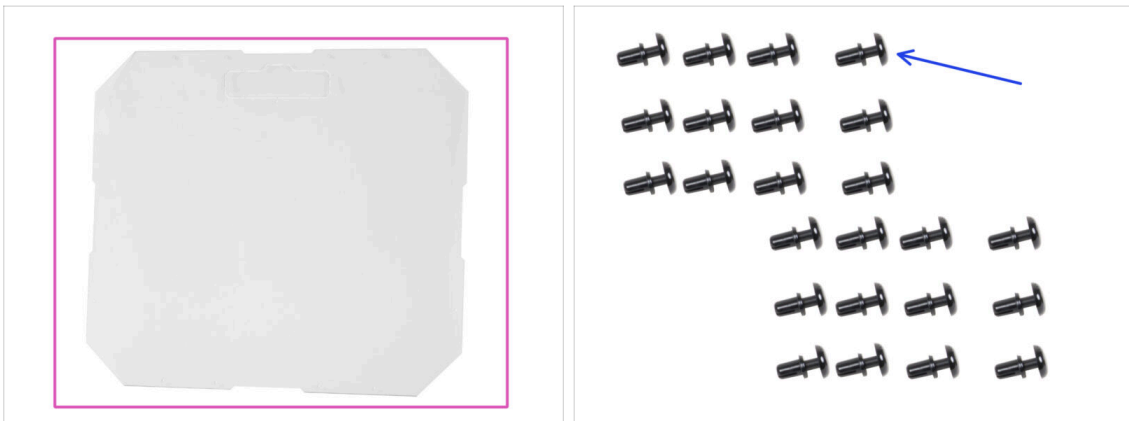

- ◆ **For the following steps, please prepare:**
- ◆ MINI Side panel (2x)
- ◆ Nylon rivet (24x)

STEP 33 Installing the side panel

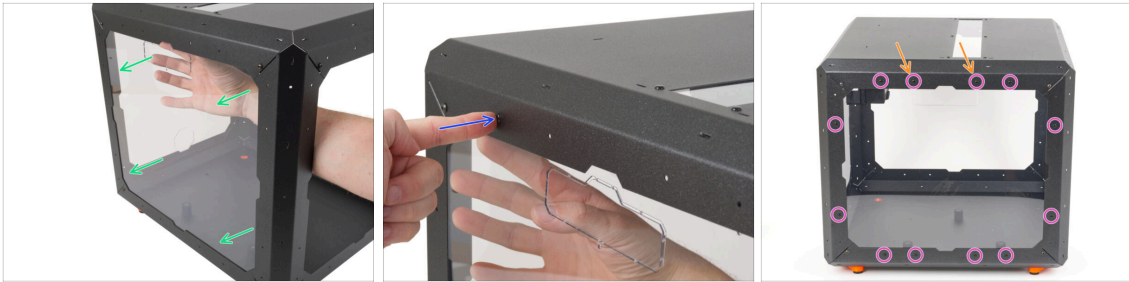

- ◆ Peel off the protective layers from both sides of the MINI Side panel.
 - ⚠ **Be careful; the panel is very susceptible to scratches.**
- ◆ From the inside, carefully place the MINI Side panel to the left side of the Enclosure.
- ◆ Align the holes of the panel and the Enclosure and secure it with one nylon rivet near the top right corner.
- ◆ In this way, secure the panel around the entire perimeter.
 - ◆ **If you are going to install the optional Transport handles, leave the marked holes empty.**

STEP 34 Transport handle (optional): parts preparation

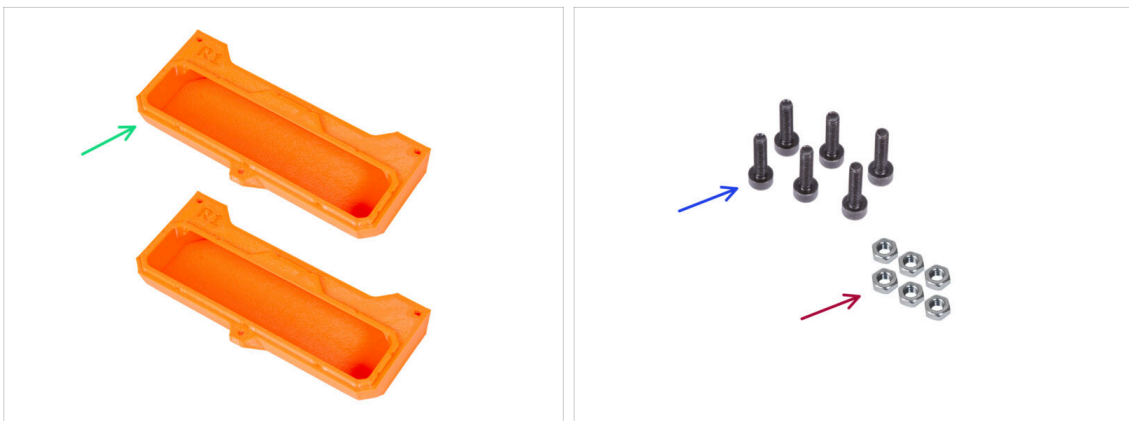

- 📌 Some of the following steps are marked as optional. If you do not need to install the handles at this time, skip to [White LED strip \(add-on\): parts preparation](#)
- ◆ **For the following steps, please prepare:**
 - ◆ Transport-handle (2x) *this part is not included in the package, you will need to print it out from [Printables.com](https://www.printables.com)*
 - ◆ M3n nut (6x)
 - ◆ M3x12 screw (6x)

STEP 35 Installing the transport handle (optional)

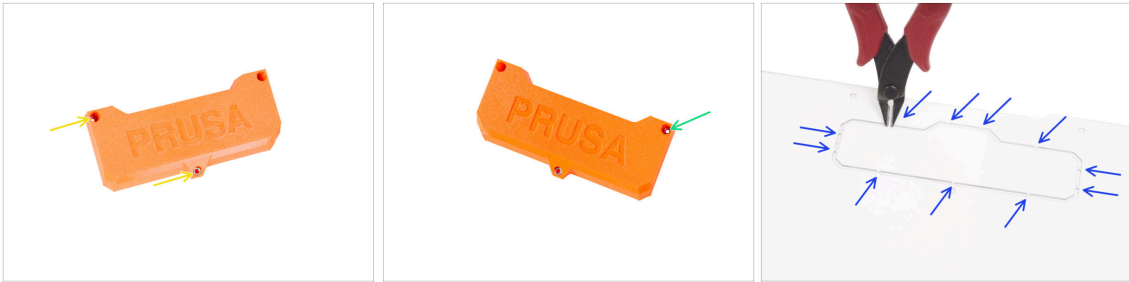

- ✦ Insert two M3n nuts into each Transport-handle.
- ✦ Insert the M3n nut from the other side into each Transport-handle.
- ✦ Using side cutters, CAREFULLY cut off all supports of each handle cutout on both side panels and remove it.

STEP 36 Mounting the transport handle (optional)



- ✦ Make sure that no nylon rivets are inserted in the two holes above the handle hole.
- ✦ From the inside, place the Transport-handle into the same shape cutout.
 - ⓘ If the insertion is difficult, try cleaning the spikes formed after cutting the cutout along the entire opening.
- ✦ Secure it with three M3x12 screws.
- ✦ Repeat the same procedure for the second Transport-handle.

STEP 37 White LED strip (add-on): parts preparation



NOTE: The following instructions are only for those who have purchased this optional add-on with the MINI Enclosure. If you have not purchased this add-on, please proceed to step [Door hinges: parts preparation](#)



NOTE: If you have installed the **Advanced filtration system** without the White LED Strip, proceed to step [Guiding the filtration cables: parts preparation \(add-on\)](#)

● For the following steps, please prepare:

- LED Stick Board (1x)

WARNING: Make sure to protect the electronics against electrostatic discharge (ESD). Always unpack the electronics right before you need them!

- LED diffuser (1x)
- LED Stick Bracket (3x)
- M3x18 screw (3x)
- M3n nut (3x)

STEP 38 Assembling the LED strip (add-on)

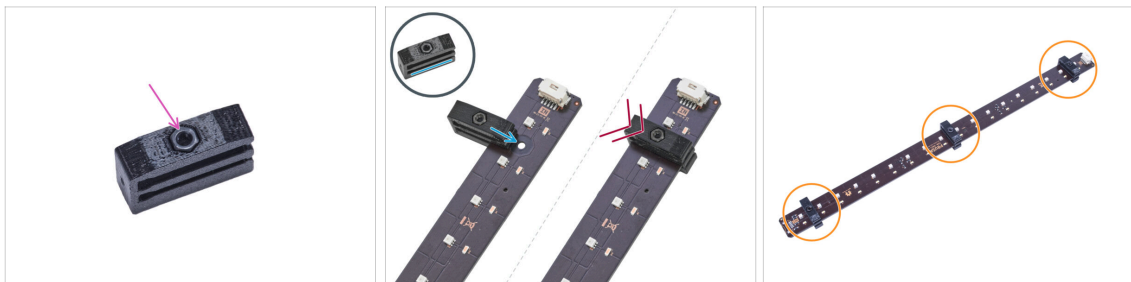

- Insert the M3n nut into each LED Stick Bracket.

⚠ The nut must be completely embedded in the printed part and flush with the surface of the part. Insufficient embedment of the nut can cause problems when mounting in the enclosure.

- Slide the lower slot of the LED Stick Bracket on the LED Stick Board and align the bracket against the first hole in the LED Stick Board closest to the (white) LED stick connector.

⚠ Avoid sliding the bracket over chips and diodes! It can be fatally damaged.

- Push the LED Stick Bracket all the way on the LED Stick Board.
- Use this procedure for all three LED Stick Brackets.

STEP 39 Assembling the LED strip (add-on)

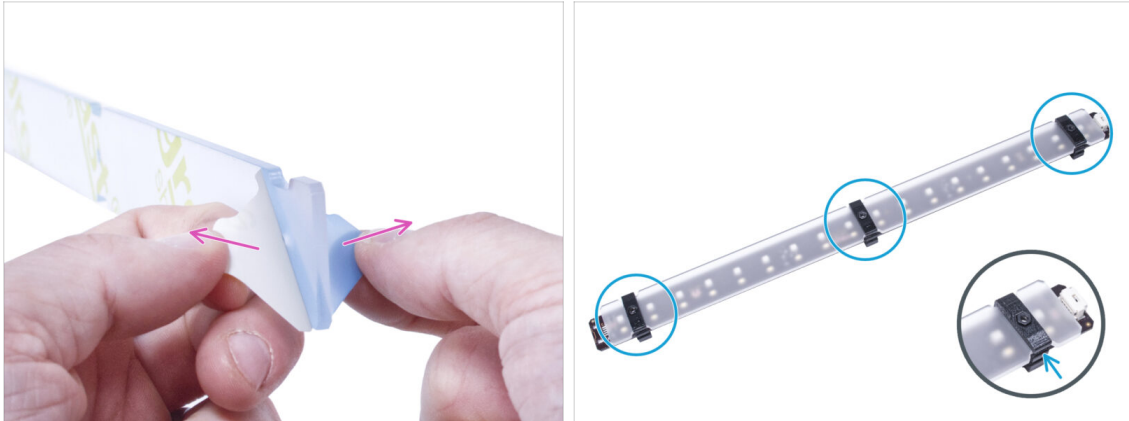

- ◆ Remove the protection films from both sides of the LED diffuser.
- ◆ Push the LED diffuser into the LED Stick Brackets. Use the upper slot.
- ⓘ The orientation of the LED diffuser doesn't matter. The part is symmetrical.

STEP 40 Mounting the LED strip (add-on)

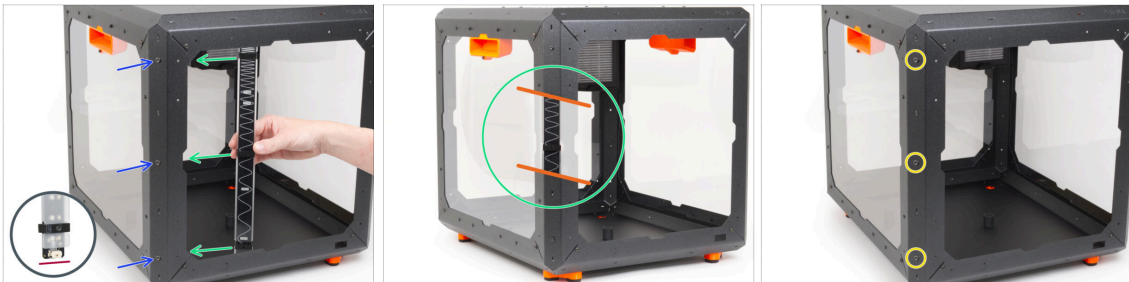

- ◆ From the outside, insert three M3x18 screws into the holes in the front left support profile.
- ◆ From the inside of the enclosure, attach the LED strip assembly so that the LED stick brackets are aligned precisely with the screws. Attach the back side (the side without the diffuser).
- ⚠ **Make sure, the LED connector is facing down.**
- ◆ Once the LED strip is aligned, attach it by tightening all three inserted M3x18 screws. Tighten them firmly but gently.

STEP 41 LED cable: parts preparation (add-on)



● For the following steps, please prepare:

● LED cable (1x)

● Zip tie (1x)

STEP 42 Guiding the LED cable (add-on)

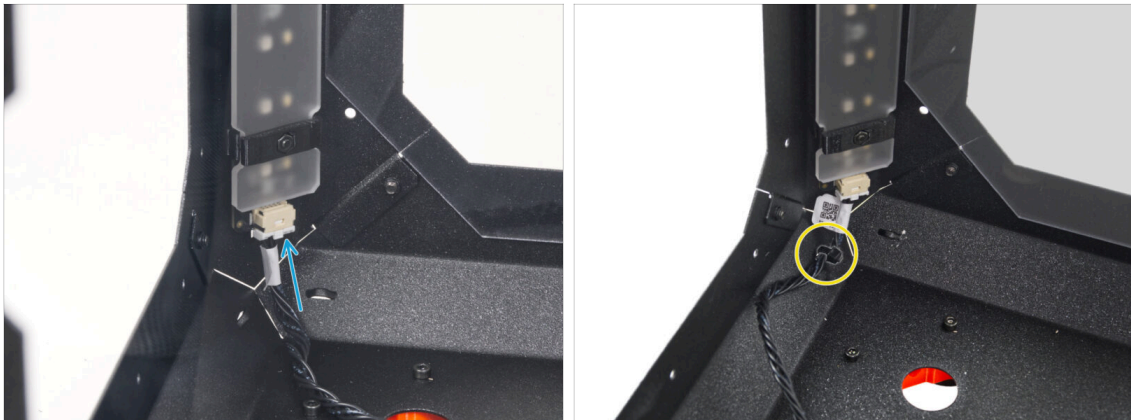

● Connect the LED cable to the connector on the bottom of the LED strip.

● Guide the zip tie through the perforation in the front left profile and secure the LED cable using the zip tie.

⚠ **Do not overtighten the zip ties, you can damage the cable.**

STEP 43 Guiding the filtration cable: parts preparation (add-on)

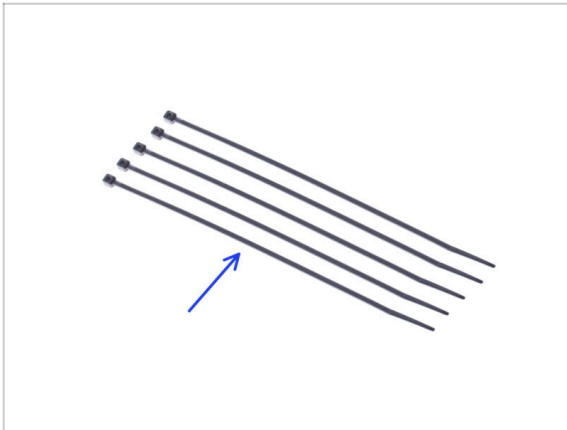

 The following steps are intended for the Advanced Filtration System only. If you don't have this add-on, skip to [Delta PSU: parts preparation \(add-on\)](#)





 **For the following steps, please prepare:**

 Zip tie (5x)

STEP 44 Guiding the add-on cables: filtration cable (add-on)



 If you have only the White LED Strip add-on, skip this step.

-  Guide the zip tie through the perforation in the top panel near the filtration.
-  Using this zip tie, secure the filtration cable. **Do not overtighten the zip tie**, as it may cause fatal damage to the cable.
-  In the same way, secure the cable to the four perforations in the left rear profile. **Do not overtighten the zip ties**, as it may cause fatal damage to the cable.
-  Leave the rest of the cable free for now.

STEP 45 USB cable: parts preparation



● For the following steps, please prepare:

- USB extension cable (1x)
- Zip tie (2x)

STEP 46 Inserting the USB cable



- Push the USB cable from the outside in through the rectangular hole in the bottom panel.
- Ensure the USB symbol on the connector is facing upwards.
- Press the connector fully into the hole with your thumbs. You should feel a slight click.
- Guide the cable along the right side of the Enclosure.
- Secure it with two zip ties. **Do not overtighten the zip ties.**

STEP 47 PSU: parts preparation (add-on)

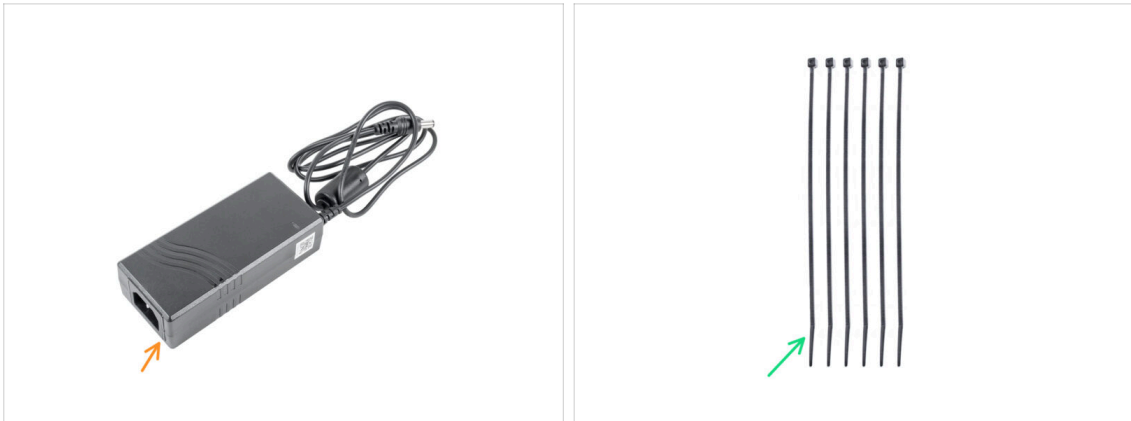

The following steps of guiding the add-ons cables apply to both the **White LED Strip** and **Advanced Filtration System** add-ons.



From October 2024 you may receive two different manufacturers of the PSU, the pictures may be different but **the assembly process is the same**.



For the following steps, please prepare:



PSU (1x)



Zip tie (6x)

STEP 48 Guiding the PSU cable (add-on)

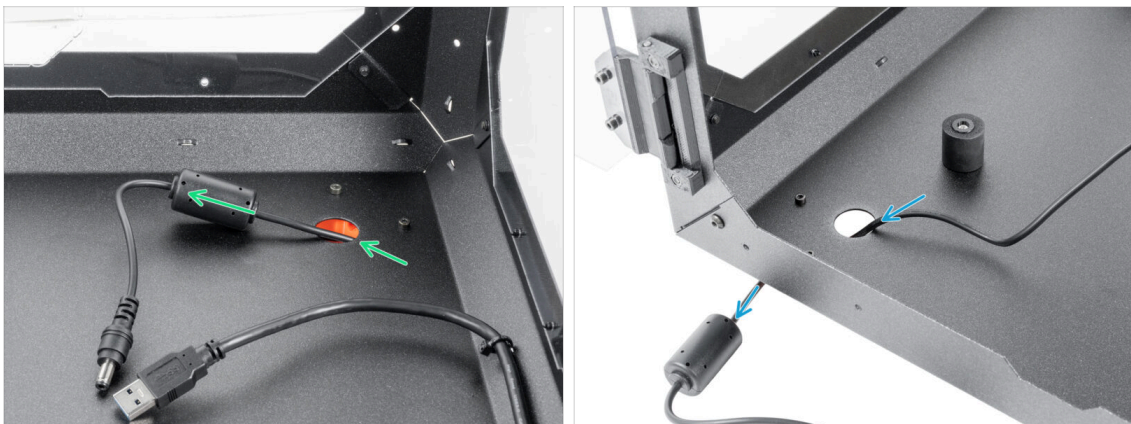

Exercise caution when handling anything inside the enclosure. There are sharp metal plates, so avoid injury.



Insert the PSU cable with the ferrite core through the circular hole at the rear of the Enclosure.



The ferrite core is smaller than the hole, slowly push it through the hole.



Guide the PSU cable with the connector through the front circle hole out of the Enclosure.

STEP 49 Releasing the front foot (add-on)

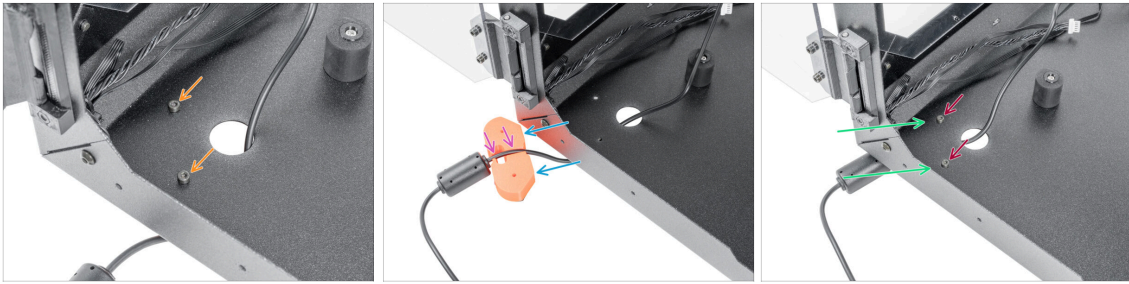

- ◆ Release and remove both M3x12 screws.
- ◆ Reposition the foot as shown. Push the PSU cable into the cable channel.
- ◆ Push the PSU cable into the cable channel.
- ◆ Close the foot back to its original position and align the holes.
- ◆ Secure the foot by inserting back the M3x12 screws and tighten them firmly.

STEP 50 Securing the PSU cable (add-on)

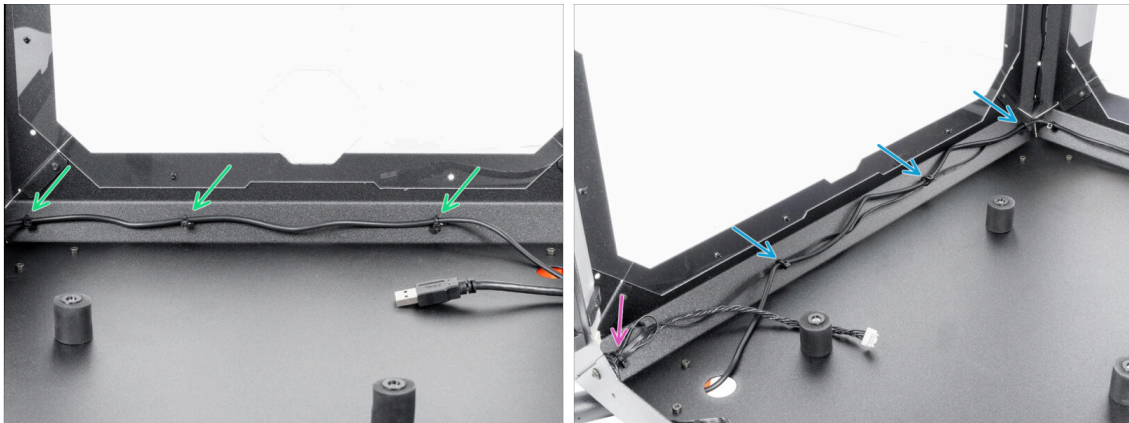

- ⚠ Exercise caution when handling anything inside the enclosure. There are sharp metal plates, so avoid injury.
- ◆ Guide the cable along the rear side of the Enclosure and secure it using three zip ties through the perforations. **Do not overtighten the zip ties, you can damage the cable.**
- ◆ Guide the PSU cable along with the FAN cable on the left side of the Enclosure and secure it with the three zip-ties. **Do not overtighten the zip ties, you can damage the cables.**
- ◆ If you have installed the Advanced Filtration System, guide the filtration cable together with the PSU cable. Secure it with one extra zip tie in the left corner. **Do not overtighten the zip tie, you can damage the cables.**

STEP 51 Printer PSU preparing

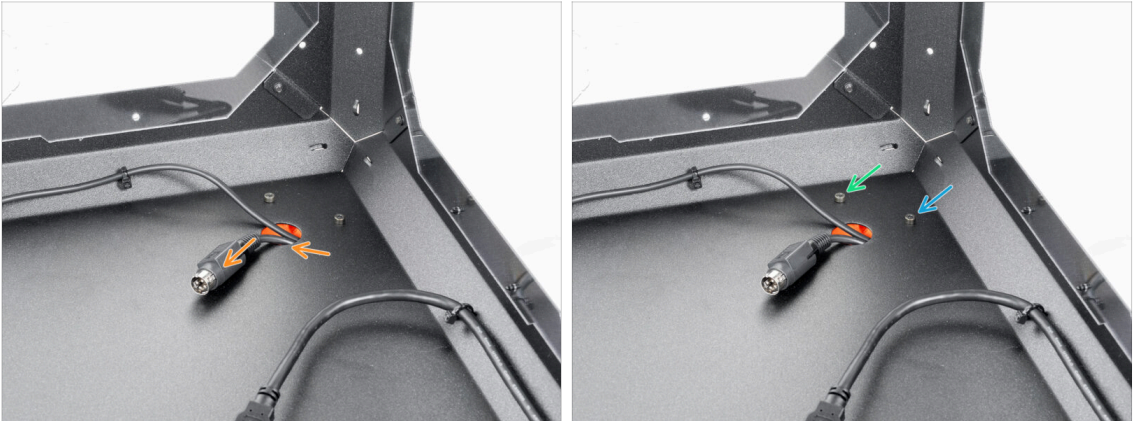

- Push the printer PSU cable through the circle hole in the rear of the Enclosure.
- Slightly loosen the left screw behind the circle hole.
- Release and remove the right screw.

STEP 52 Inserting the printer PSU cable

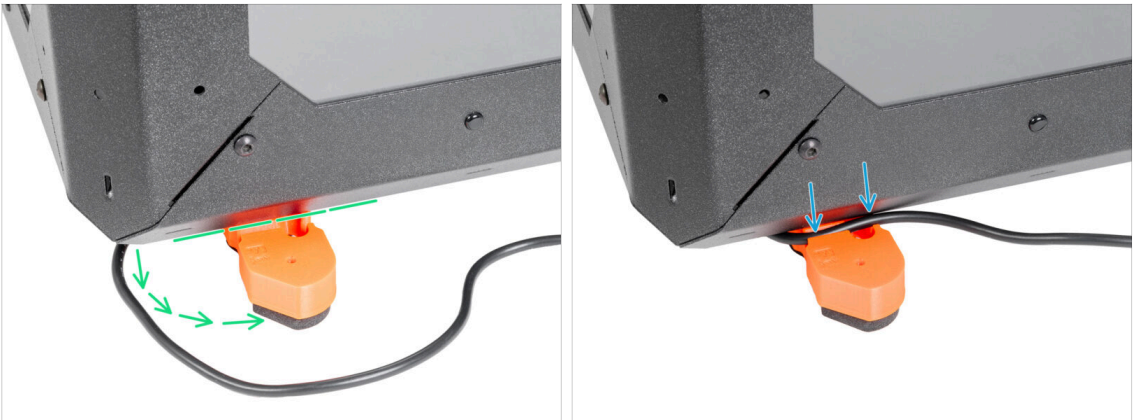

- Reposition the foot as shown in the picture. The cable channel must be accessible.
 - Push the PSU cable into the cable channel.
- ⓘ Tip: You can use the 2.5 mm Allen key to make it easier to squeeze the cable into the channel. But gently!

STEP 53 Securing the printer PSU cable



- Close the foot back to its original position and align the holes in the foot and Enclosure.
 - i Tip: You can inspect the position through the Top window panel.
- After aligning the hole, secure the foot by inserting back the M3x12 screw.
- Fully tighten the left screw.

STEP 54 Basic Board: parts preparation (add-on)

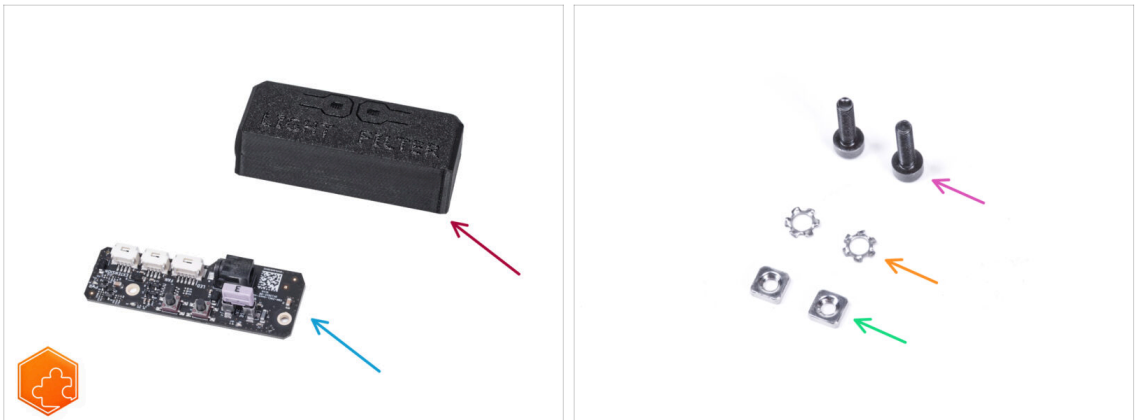

The following steps apply to both the **White LED Strip** and **Advanced Filtration System** add-ons.

For the following steps, please prepare:

- Basic Board Cover (1x)
- Basic board (1x)
- M3x12 screw (2x)
- M3w serrated lock washer (2x)
- M3nS nut (2x)

STEP 55 Installing the Basic Board (add-on)



- ◆ Mount the M3nS nut on the M3x12 screw. Attach it in a few threads on the tip of the screw.
- ◆ Push the screw with the nut all the way into the same shape hole inside the Basic Board Cover.
- ◆ Remove the screw from the nut.

STEP 56 Installing the Basic Board (add-on)

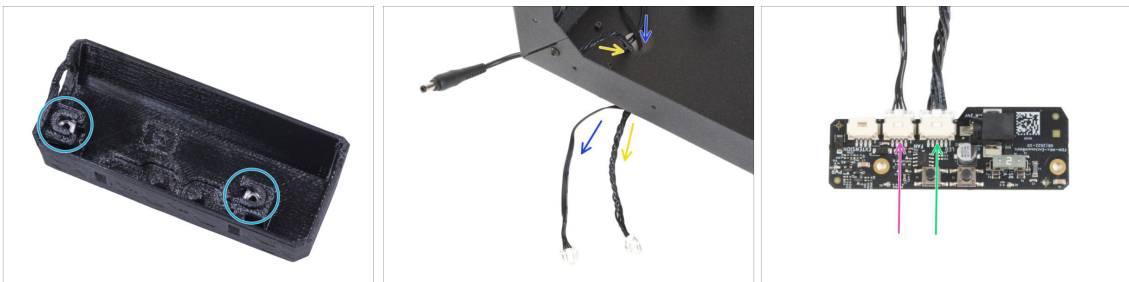

- ◆ Use the same procedure for both slots in the Basic Board Cover.
- ◆ Guide the LED cable through the hole in the bottom panel out of the Enclosure.
- ◆ Guide the filtration cable through the hole in the bottom panel out of the Enclosure.
- ◆ Connect the filtration cable to the Basic Board slot labeled FAN.
- ◆ Connect the LED cable to the Basic Board slot labeled LED.

STEP 57 Assembling the Basic Board (add-on)



- From the inside the Enclosure, insert two M3x12 screw through the front profile.
- Attach two M3w serrated lock washer on the screws.
- Place the Basic Board into the Basic Board Cover and align the holes on both parts.

STEP 58 Mounting the Basic Board (add-on)

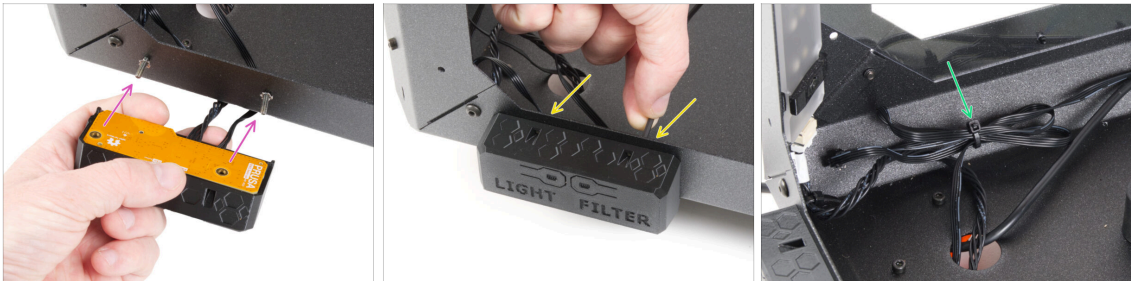

- Take the Basic Board assembly and align the holes with the screws in the profile.
- Attach the Basic Board assembly to the screws and tighten the screws from the inside.
- It is recommended to make a loop with the excess cable and secure it with a zip tie. This way, the cable will not get in the way.

STEP 59 Connecting the Basic Board (add-on)



- Connect the external PSU cable to the basic board from the left side.

STEP 60 PSU holder clarification (optional)



 These steps are only for LED strip and Advanced filtration system owners only. The smaller PSU space is for those with additional PSU. Otherwise, skip to **Door hinges: parts preparation**

- PSU holder is not included in the package, you will need to print it out from [Printables.com](https://www.printables.com)

 **Before starting printing, check what type of PSU you have!**

- XP PSU: This PSU is larger than the Delta PSU. You will need the:
 - **Current-PSU-holder-XP.stl**
 - **Add-on PSU-holder-A-XP.stl**
 - **Add-on PSU-holder-B-XP.stl**
- Delta PSU: This PSU is smaller than the XP PSU. You will need the:
 - **Current-PSU-holder.stl**
 - **Add-on PSU-holder-A.stl.**
 - **Add-on PSU-holder-B.stl**

STEP 61 PSU holder: parts preparation (optional)

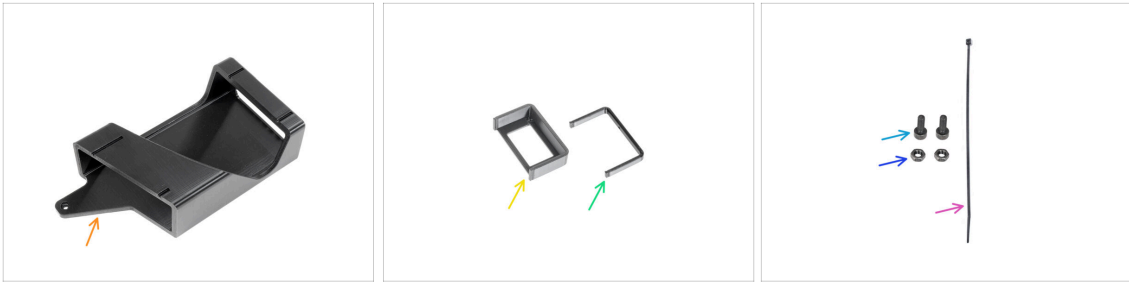

These steps are only for LED strip and Advanced filtration system owners only. The smaller PSU space is for those with additional Delta PSU. Otherwise, skip to **Door hinges: parts preparation**

For the next steps, please prepare:

- PSU-holder (1x) *this part is not included in the package, you will need to print it out from [Printables.com](https://www.printables.com)*
- Add-on PSU-holder-A (1x) *this part is not included in the package, you will need to print it out from [Printables.com](https://www.printables.com)*
- Add-on PSU-holder-B (1x) *this part is not included in the package, you will need to print it out from [Printables.com](https://www.printables.com)*
- M3x8 screw (2x)
- M3n nut (2x)
- Zip-tie (1x)

STEP 62 PSU holder nut preparation (optional)

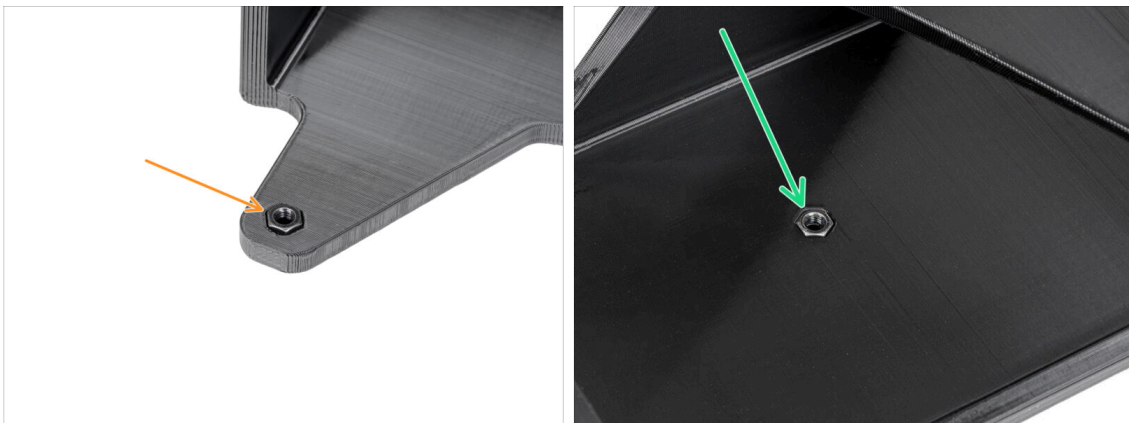

- Insert the M3n nut into the PSU-holder.
- Insert the M3n nut into the PSU-holder.

STEP 63 PSU holder preparation (optional)

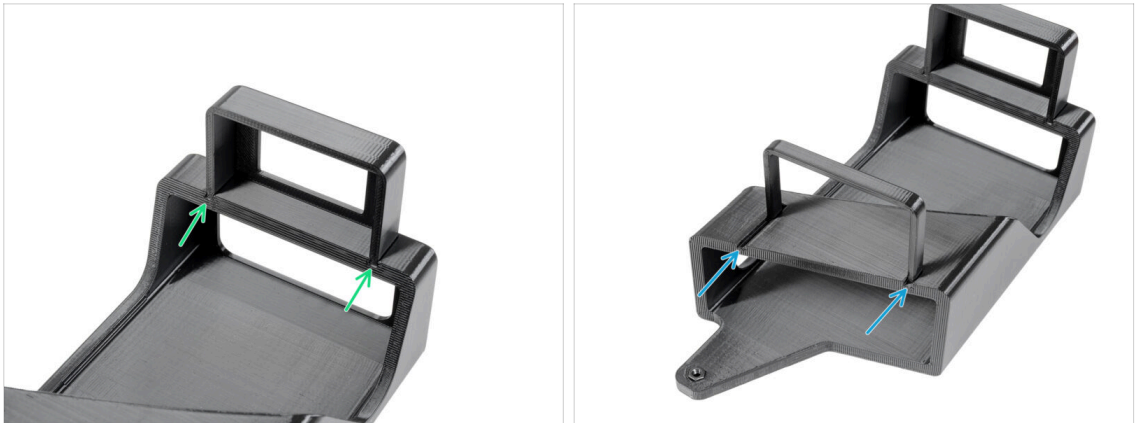

i These steps are only for LED strip and Advanced filtration system owners only. The smaller PSU space is for those with additional Delta PSU.

- Attach the Add-on PSU-holder-A to the rails on the PSU-holder.
- Attach the Add-on PSU-holder-B to the rails on the PSU-holder.

STEP 64 Attaching the PSU holder (optional)

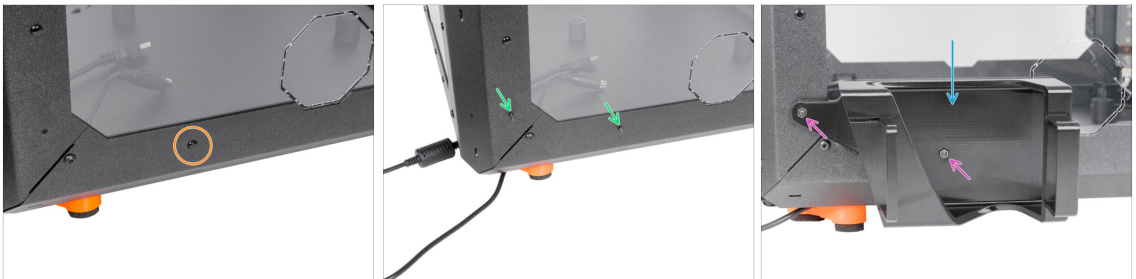

- Remove the nylon rivet on the left bottom corner.
i Hint: use a pliers from inside the enclosure to push the nylon rivet out
- From the inside of the enclosure, insert two M3x8 screws through the cut-outs.
- Attach the PSU-holder on the screws.
- Secure the screws from the inside.

STEP 65 Securing the PSUs (optional)

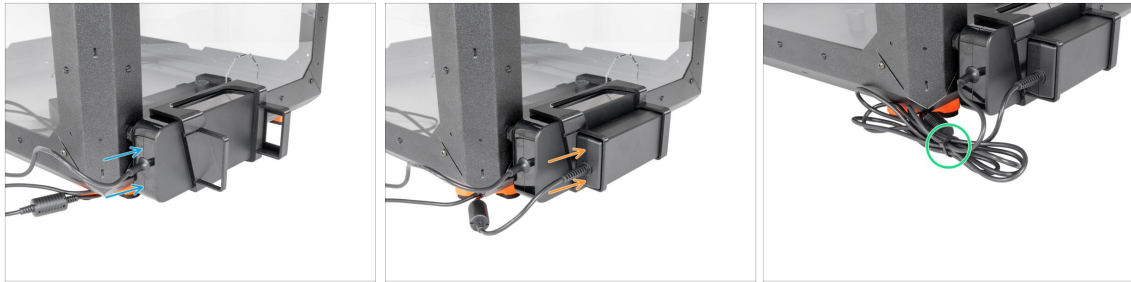

- ◆ Insert the printer PSU into the PSU-holder.
- ◆ Insert the add-on PSU into the PSU-holder.
- ◆ Secure the cables together with a zip-tie.

STEP 66 Door hinges: parts preparation

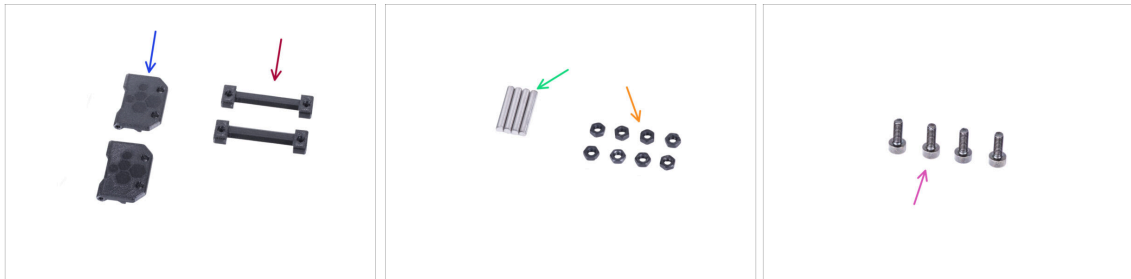

- ◆ **For the following steps, please prepare:**
- ◆ Door-hinge (2x)
 - ◆ Enclosure hinge (2x)
 - ◆ Pin 3x20 (4x)
 - ◆ M3n nut (8x)
 - ◆ M3x8 screw (4x)

STEP 67 Assembling the hinges



- Place the enclosure hinge into the door hinge. See the correct orientation of both parts.
- ⚠ **Look carefully at the orientation of both parts. Their reverse disassembly is impossible.**
- Insert the pin from both side of the hinge.
- Push two pins all the way into the hinge against a hard surface (e.g. workshop table). The end of the pin must be aligned with the surface of the printed part.
- Insert four M3n nuts into the hinge assembly.
- Repeat the same for the second hinge.

STEP 68 Mounting the hinges

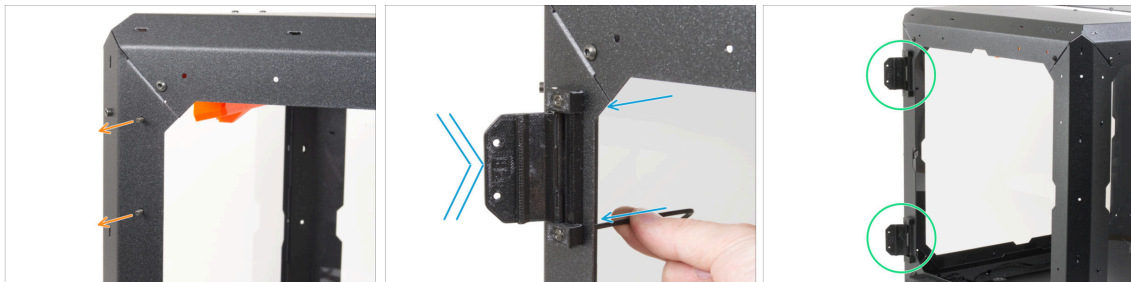

- ⓘ In the following instructions, we will install the hinges on the left side. However, it is optional which side you install the hinges on. The procedure is identical and does not affect the later installation of the door.
- Turn the enclosure with the front side facing to you.
- Locate two holes on the top of the left support. **From the inside**, insert two M3x8 screws.
- Attach the hinge on the screws and tighten the screws. **Mind the correct orientation of the hinge.**
- Use the same procedure to mount the upper door-hinge.

STEP 69 Mechanical lock (add-on): parts preparation

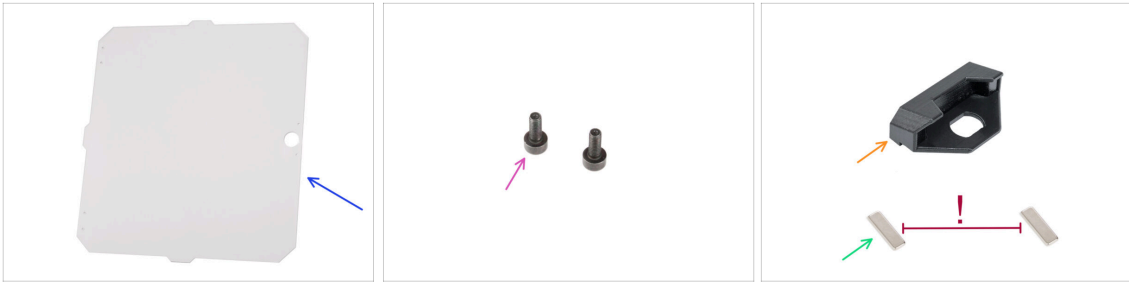

- If you do not need to install the Lock at this time, skip to **Door assembly: parts preparation**
 - **For the following steps, please prepare:**
 - MINI Door panel (1x)
 - M3x8 screw (2x)
 - MINI Enclosure Door Handle (1x)
 - Magnet 20x6x2 (2x)
- ⚠ **Keep the magnets apart in a sufficient distance. They can break each other!**

STEP 70 Assembling the lock insert (add-on): parts preparation



- **For the following steps, please prepare:**
 - Lock housing nut (1x)
 - Lock housing (1x)
 - Lock wrench (1x)

STEP 71 Assembling the lock housing (add-on)



- ◆ Insert two magnets all the way into two pockets in the door handle.
 - ⓘ The polarity of the magnets doesn't matter.
- ◆ Turn the door handle.
- ◆ Insert the lock housing into the same shape opening in the door handle.

STEP 72 Securing the lock housing (add-on)

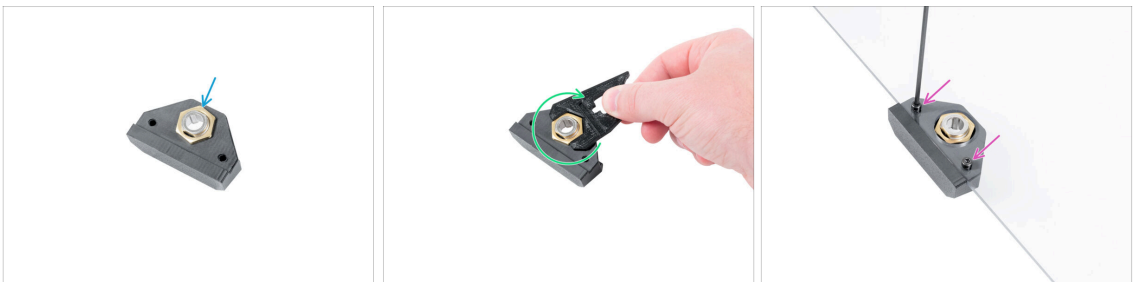

- ◆ From the opposite side:
 - ◆ Insert the nut onto the lock housing.
 - ◆ Secure the lock housing by tightening the lock housing nut. Use the lock wrench for easier tightening.
 - ◆ Attach the door handle on the door panel and secure it with two M3x8 screws.

STEP 73 Assembling the lock mechanism (add-on): parts preparation

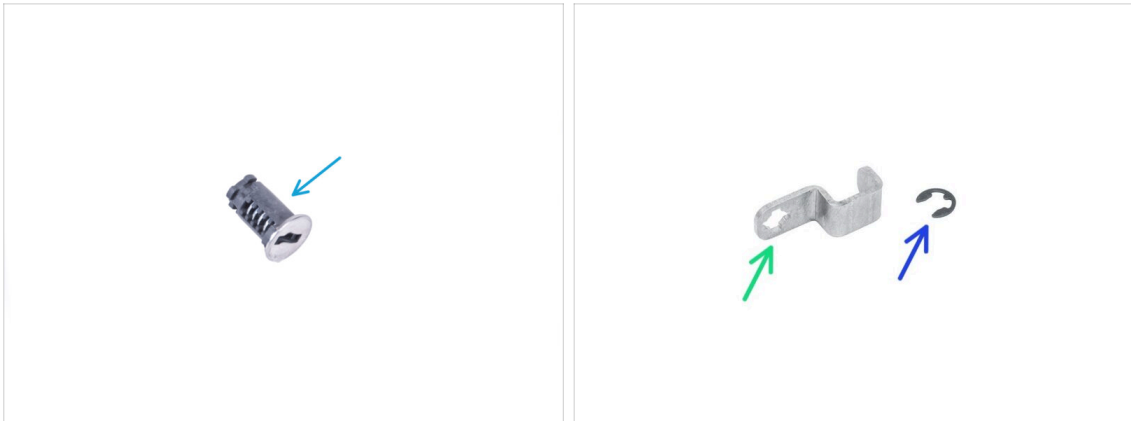

● For the following steps, please prepare:

- Lock (1x)
- Mechanical Lock Lever (1x)
- E-clip washer (1x)

STEP 74 Assembling the lock mechanism (add-on)



- Insert the Lock into the lock mount.
- Hold the Lock in the Lock mount with your hand and turn the door panel.
- Attach the Mechanical Lock Lever to the Lock.

STEP 75 Securing the lock mechanism (add-on)

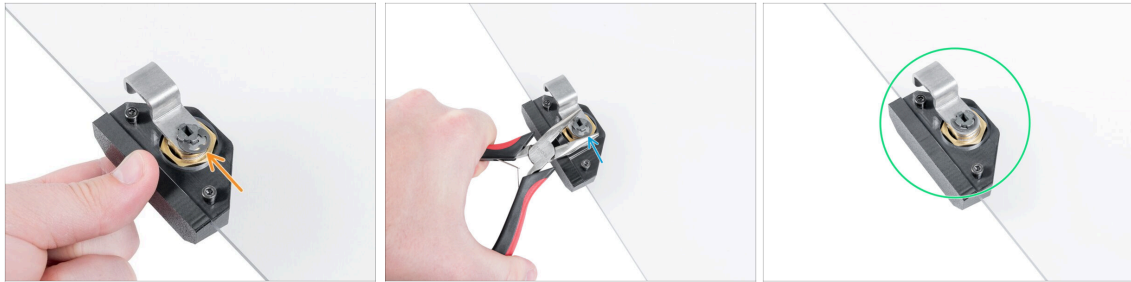

- 🟠 Place E-clip washer on the Mechanical Lock Lever against the lock.
- 🟢 Attach the Lock wrench on the lock and the washer. Using Needle-nose pliers, push the E-clip washer on the lock to secure the lock mechanism.
- 🟢 The Mechanical Lock is ready. Compare the picture with your Mechanical Lock.

STEP 76 Installing the door panel (add-on): parts preparation



- 🟡 **For the next step, please prepare:**
- 🟠 M3x8 screw (4x)

STEP 77 Installing the door panel (add-on)

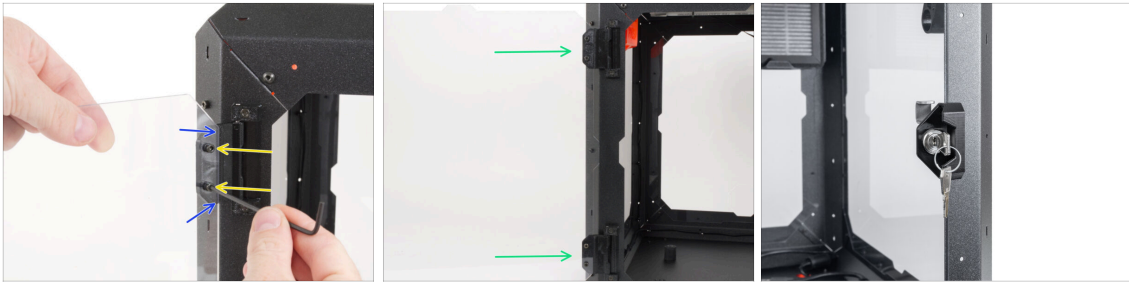

⚠ Do not overtighten the screws in the door panel! The panel could crack.

- 🔵 Take the door panel assembly and place it on the open hinges on the left side of the enclosure.
- 🟡 Secure the door assembly by tightening two M3x8 screws to the top hinge.
 - 📄 **i** Look at the detail for a better illustration of how the door panel is attached to the hinge.
- 🟢 Repeat the same for the bottom hinge.
- ⬛ Well done!

STEP 78 Door assembly: parts preparation

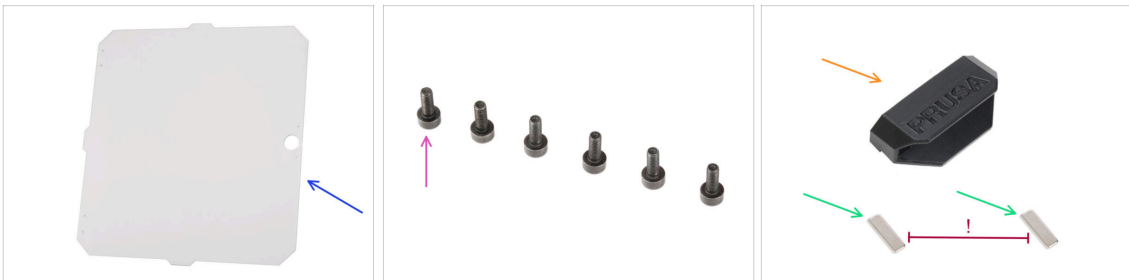

⬛ **For the following steps, please prepare:**

- 🔵 MINI Door panel (1x)
- 🟡 M3x8 screw (6x)
- 🟠 MINI Enclosure Door Handle (1x)
- 🟢 Magnet 20x6x2 (2x)

⚠ Keep the magnets apart in a sufficient distance. They can break each other!

STEP 79 Installing the door panel

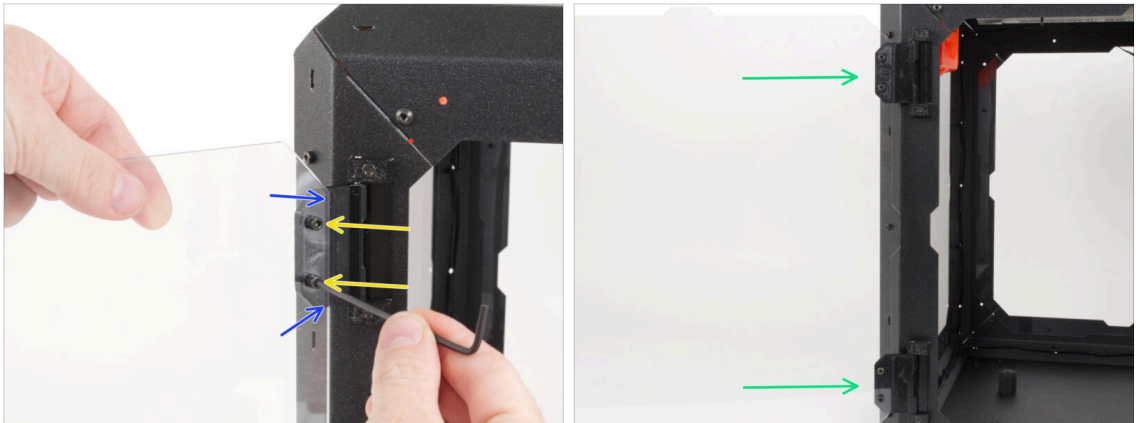

⚠ Do not overtighten the screws in the door panel! The panel could crack.

- ◆ Take the door panel assembly and place it on the open hinges on the left side of the enclosure.
- ◆ Secure the door assembly by tightening two M3x8 screws to the top hinge.
- ⓘ Look at the detail for a better illustration of how the door panel is attached to the hinge.
- ◆ Repeat the same for the bottom hinge.

STEP 80 Assembling the door handle



- ◆ Insert two magnets all the way into two pockets in the door handle.
- ⓘ The polarity of the magnets doesn't matter.
- ◆ Attach the door handle on the door panel **from the outside**.
- ◆ Secure it with two M3x8 screws
- ⚠ Do not overtighten the screws in the door panel! The panel could crack.**
- ◆ Close the door to ensure the handle is mounted correctly.

STEP 81 Haribo time!



- ◆ That was easy, wasn't it? Reward yourself and replenish your energy for the next chapter.
- ◆ Eat the second row of the gummy bears. Leave the others!

STEP 82 Good job!

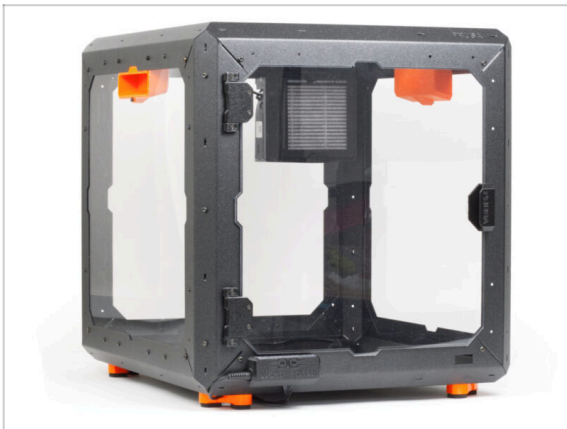

- ◆ Perfect! You just successfully assembled the Original Prusa MINI Enclosure.
- ◆ Now it's time to put the printer inside. Let's move to chapter 3. **Installing the printer.**

3. Installing the printer



STEP 1 Tools necessary for this chapter

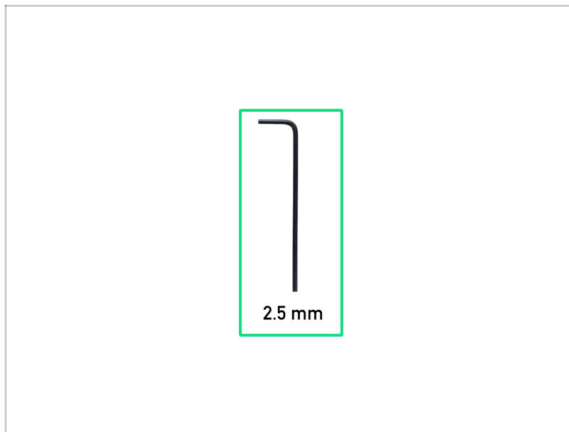

- For this chapter, please prepare:
- 2.5mm Allen key

STEP 2 Setting up the printer

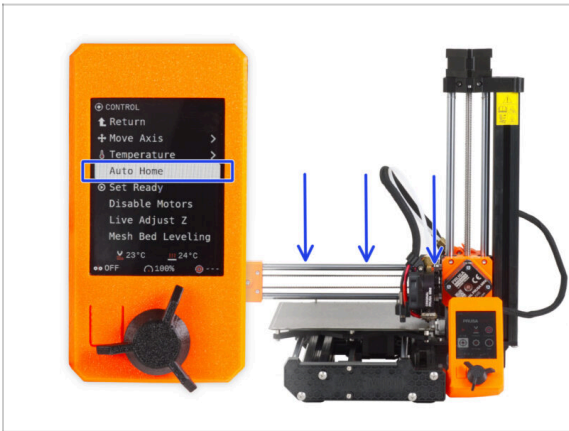





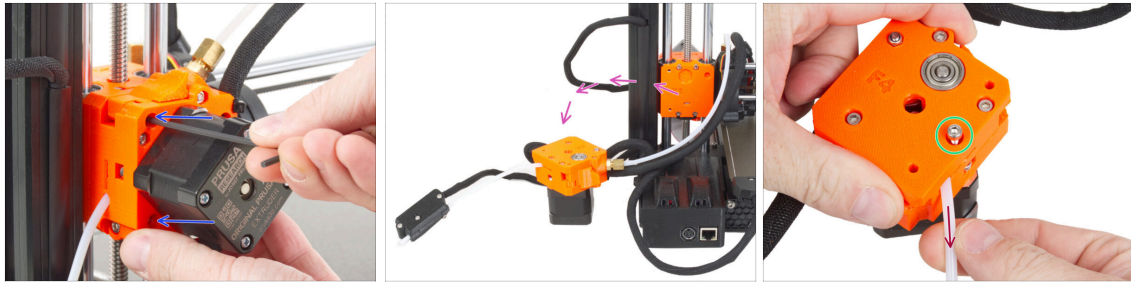

- Plug the printer and turn it ON.
- Completely unload the filament from the printer.
- To make handling the printer easier, lower the Z-axis to its lowest possible point.
 - Firmware 4.4.0 and newer: using the LCD knob navigate to *Control* -> *Auto Home*.
 - Up to firmware 4.3.4: using the LCD knob navigate to *Calibration* -> *Auto Home*.
- **i** **Where can you find the firmware version?** On the printer screen, navigate from the main screen to *Info* -> *Version info*.
- **! Make sure the printer has cooled down to room temperature.** Check the values on the printer's screen.
- Turn the printer OFF and disconnect it from the outlet.

STEP 3 Removing the input PTFE tube (optional)





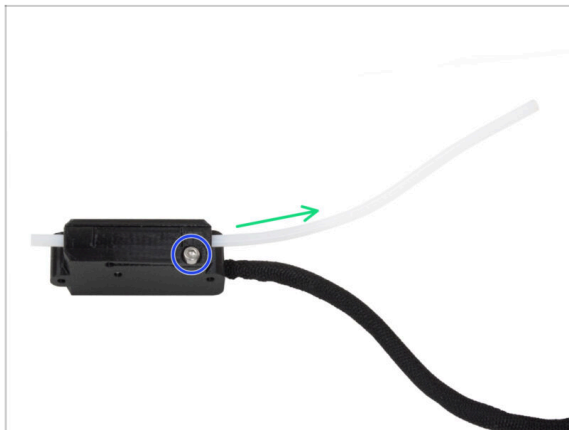

 The following steps will show how to replace the original input PTFE tube with a longer tube. Replacing the input PTFE tube for a longer one is optional, but recommended for easier filament insertion. If you don't want to replace the PTFE, skip to [USB cable: parts preparation](#).

-  Hold the extruder with one hand.
 -  Using your second hand, release two screws securing the extruder to the Z-carriage.
 -  Carefully take the extruder off the printer and place it next to it.
 -  Loosen the screw on the plastic part of the extruder. The screw does not need to be removed, just a few turns are sufficient.
 -  Pull out the input PTFE tube from the extruder.
-  If it is difficult to remove, use pliers to pull it out.

STEP 4 Removing the filament sensor (optional)



 **This step is intended for printers with the filament sensor.** If your printer does not have the filament sensor, skip this step.

-  Slightly loosen the top screw on the filament sensor.
 -  Pull out the longer PTFE tube.
-  If it is difficult to remove, use pliers to pull it out.

STEP 5 Input PTFE tube: parts preparation (optional)

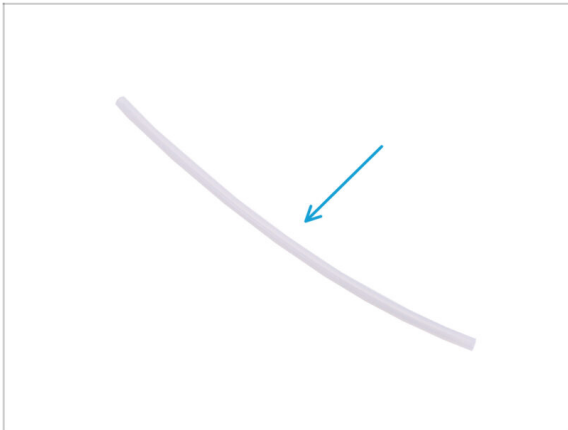

◆ For the following steps, please prepare:

- ◆ PTFE tube 4x2.5x360 mm (1x)

STEP 6 Inserting the PTFE tube

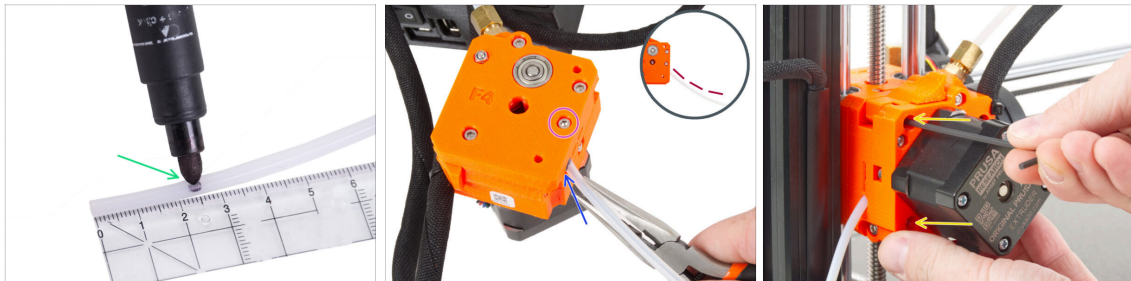

- ◆ It's recommended to mark the distance of 2.5 cm (0.98 inches) from the end of the PTFE tube before the insertion to the extruder. Both ends are symmetrical.
- ◆ Locate the hole for the PTFE tube on the side of the extruder assembly and insert the marked end of the tube all the way to the extruder. Check the correct insertion according to the marking on the tube.
- 🔗 You can use pliers for insertion. However, **ensure a piece of filament is inserted in the PTFE tube to prevent deformation.**
- ◆ Check that the PTFE tube is bent in the correct direction (see the detail).
- ◆ Secure the tube by tightening the M3x12 screw.
- ◆ Attach the extruder back to the Z-carriage.
- ◆ Hold the extruder with one hand and using your second hand secure the extruder by tightening two M3x25 screws. Tighten firmly.

STEP 7 Filament sensor installation (optional)

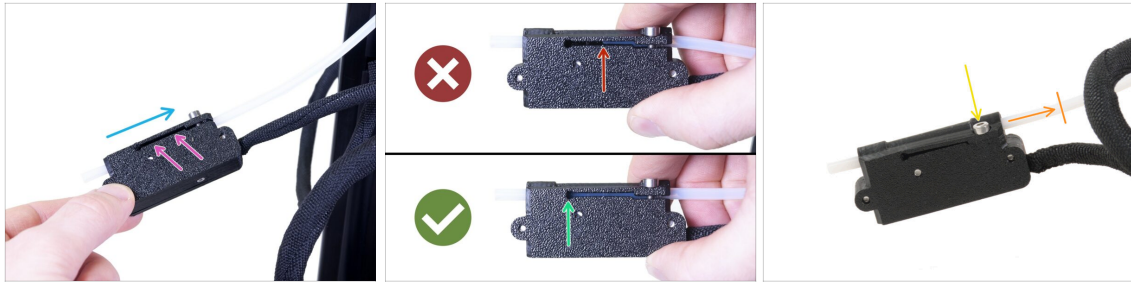

- Slide the filament sensor onto the PTFE tube. See the picture for the correct orientation of the sensor.
- Check the position of the PTFE tube through the groove:
 - **Wrong installation.** The filament sensor is not fully pushed onto the PTFE tube. The filament sensor will not work properly.
 - **Correct installation.** The filament sensor is fully pushed onto the PTFE tube.
- Now, tighten the screw gently to ensure the sensor won't slide from the PTFE tube.
- Use a piece of filament and slide it through the filament sensor to ensure the proper functioning of the tube. In case of any resistance, release the screw slightly.

STEP 8 Preparing the printer

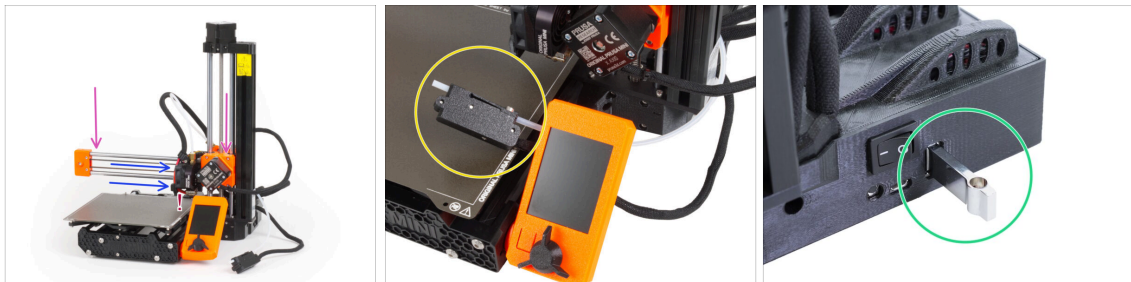

- In the following steps, we will insert the printer into the enclosure. **Before that, we need to check the following:**
 - Z-axis is in the **lower position**.
 - **⚠ Ensure that the nozzle does not touch the printing surface!**
 - Ensure the print head is in the **rightmost position**.
 - If you have the filament sensor, you can temporarily hook it to the LCD. This will prevent it from getting in the way during insertion.
 - Remove the USB stick from the printer.

STEP 9 Installing the printer

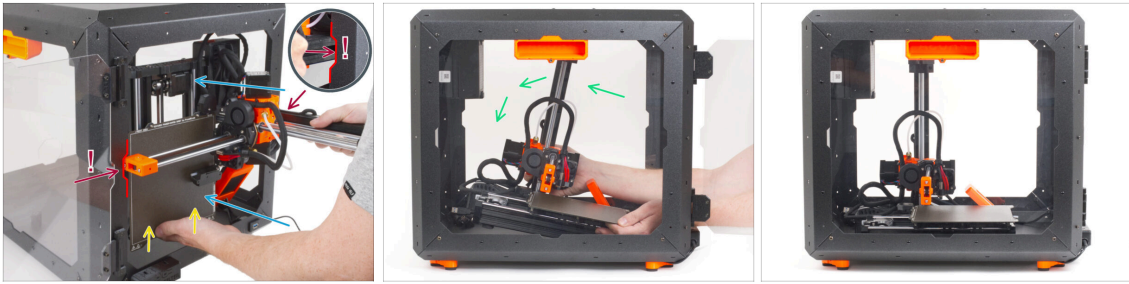

- Carefully insert the printer inside the enclosure with its base facing forward. **When doing so, be EXTRA CAREFUL to:**
 - ⚠ **Ensure the X-end and aluminum Z-axis profile pass through the right and left cutouts of the front opening. Use EXTRA CAUTION to avoid damaging the printer or enclosure.**
 - **Hold the heatbed with your left hand to prevent it from sliding down and getting damaged on the bottom plate.**
 - **During insertion, carefully watch all sides of the printer to ensure nothing is in the way (e.g., cables, motors, etc.).**
- Carefully place the printer on its feet. We will adjust the exact position later on.
 - ⚠ **Ensure that no parts of the printer touch the side panels to avoid scratches.**

STEP 10 Connecting the PSUs: parts preparation (add-on)



- **For the next steps, please prepare:**
- Power cord Y-splitter (1x)

STEP 11 Connecting the PSUs (add-on)



- Connect the plug ends to the PSUs.
- Connect the second end of the power cord Y-splitter to the power cable.

STEP 12 Connecting the cables

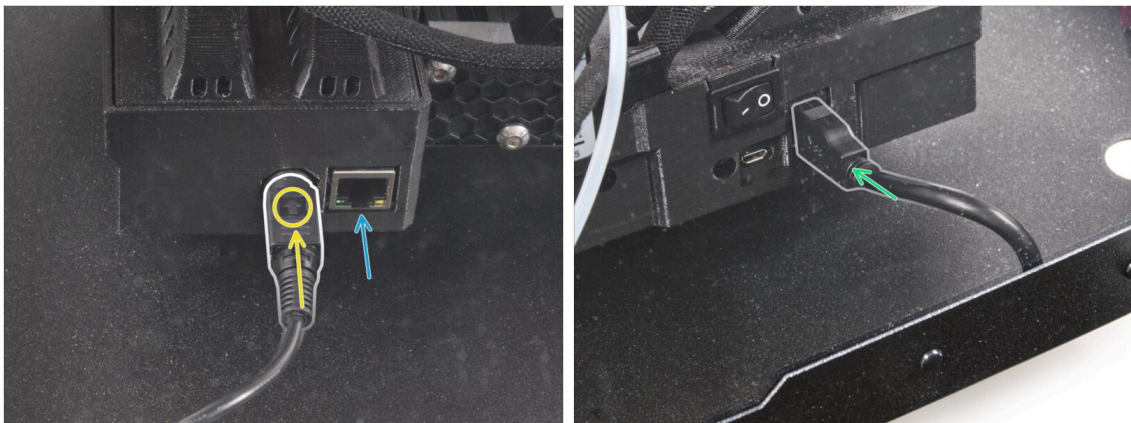

- From the back of the printer, connect the PSU power cable. See the correct orientation of the cable.
- ⓘ If the space is difficult to access, move the printer closer to the front, **avoiding scratches on the panels.**
- If necessary, connect an ethernet cable, which is optional.
- Connect the USB extension cable from the right side of the printer.

STEP 13 Adjusting printer position

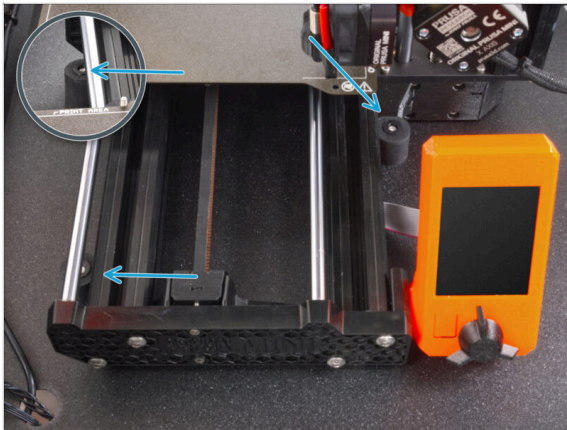

- Rearrange position of the printer like in the picture. The **printer must be placed between all three anti-slip dampers.**

STEP 14 Thermometer: parts preparation



- **For the following steps, please prepare:**
- Temperature sensor (1x)
- Thermometer-bracket (1x)
- M3x8 screw (2x)
- M3n nut (2x)

STEP 15 Assembling the thermometer



- Insert two M3n nuts into the Thermometer-bracket.
- Pull out the plastic tab from the temperature sensor.
- Insert the temperature sensor in the Thermometer-bracket. Push on it by your thumbs until you feel a slight "click". **Avoid pressing on the screen, you can damage it.**
- From the inside, mount the thermometer to the top left corner. Secure it with two M3x8 screws.

STEP 16 Spool holder: parts preparation

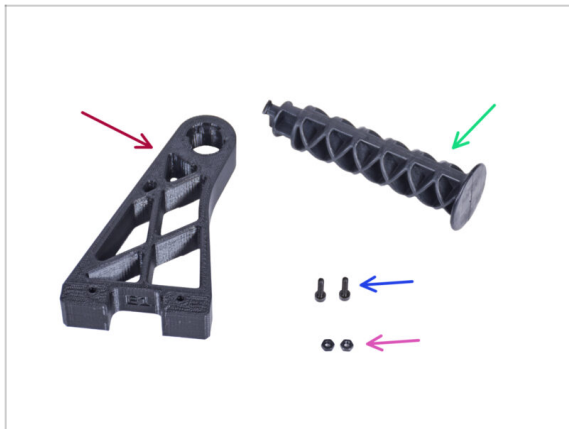

- For the following steps, please prepare:**
- Spool-holder-r (1x)
- Side arm (1x)
- M3x12 screw (2x)
- M3n nut (2x)

STEP 17 Installing spool holder

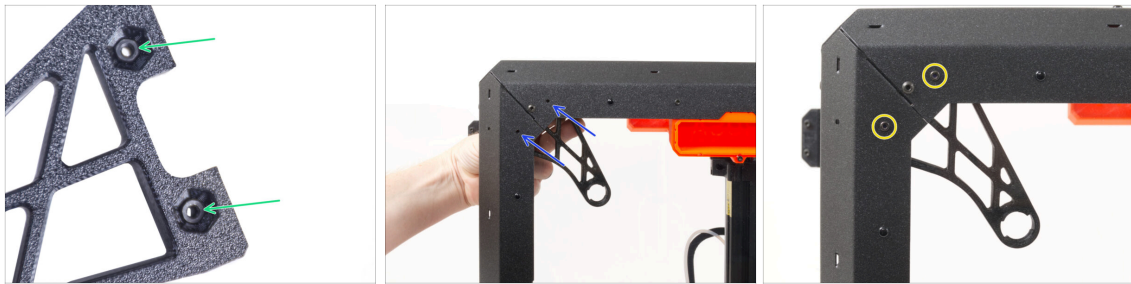

- ◆ Completely insert two M3n nuts into the holes in the Spool-holder-r.
- ◆ From the inside, align the holes of the Spool-holder-r with the corner on the right side of the enclosure. Ensure the orientation is correct.
- ◆ Secure the Spool-holder-r with two M3x12 screws.

STEP 18 Mounting the side arm



- ◆ Insert the side arm into the Spool-holder-r and turn counter-clockwise to lock it.

3. Installing the printer

STEP 19 Sticking the label



- And the very last thing, stick the silver label including the serial number on the rear side of the Enclosure.
- Locate the silver label with the serial number in your package.
- Place it on near the right bottom corner.

STEP 20 Haribo time!



- You have successfully installed the printer into the enclosure. This requires a certain reward!
- Eat the remaining gummy bears from the third row.

STEP 21 That's it



- ◆ That's all! Great job. You have successfully assembled the Original Prusa MINI Enclosure. Now, let's try it out.
- ◆ On the right side of the printer, turn the power switch ON.
- ◆ You can now hang the filament spool on the spool holder and load the filament into the printer and start printing.

Advanced filtration system (add-on)

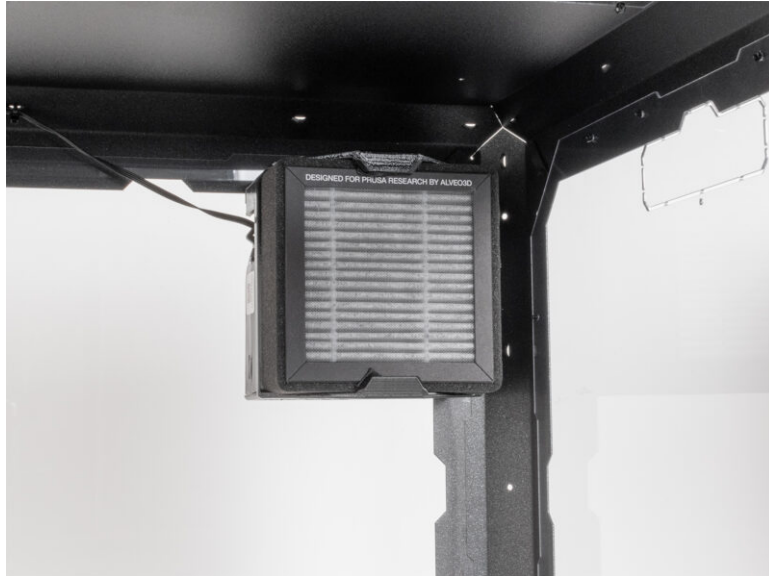

STEP 1 Tools necessary for this chapter

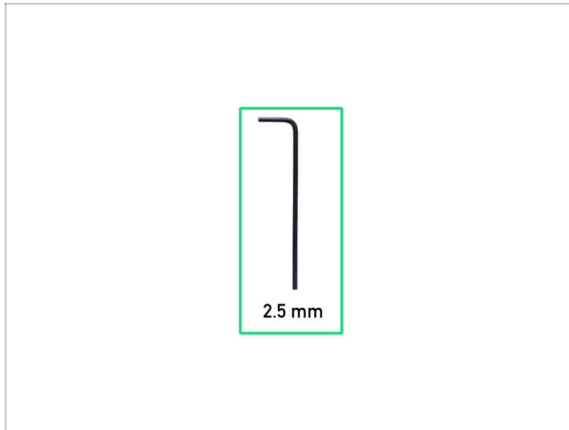

- For this chapter, please prepare:
- 2.5mm Allen key

STEP 2 Additional tools



- ⓘ Tools that are not included but can make assembly easier, especially when installing add-ons.
- Additional tools:
- Side cutters *for cutting zip ties and removing the nylon rivets*

STEP 3 Optional parts

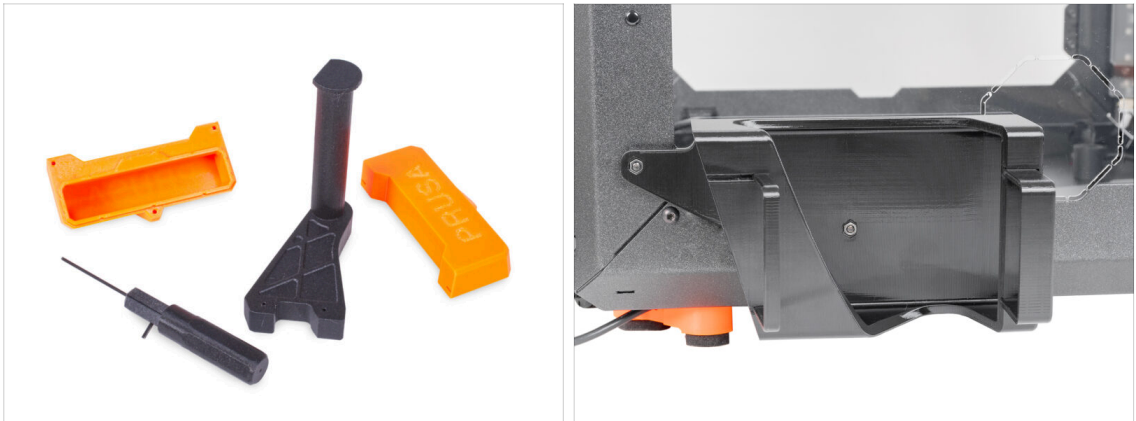

- We have designed enhancements that are not shipped by default in the kit, but you can print them out and add them to the enclosure during assembly. Fasteners are already included in the kit.

⚠ **Print out the parts before you start assembly.**

- To see the full list of the parts, please visit our collection at [Printables.com](https://www.printables.com).

STEP 4 Removing the side arm



- Grasp the Spool-holder-r and turn clockwise to unlock it and remove it from the MINI Enclosure.

STEP 5 Disconnecting the cables

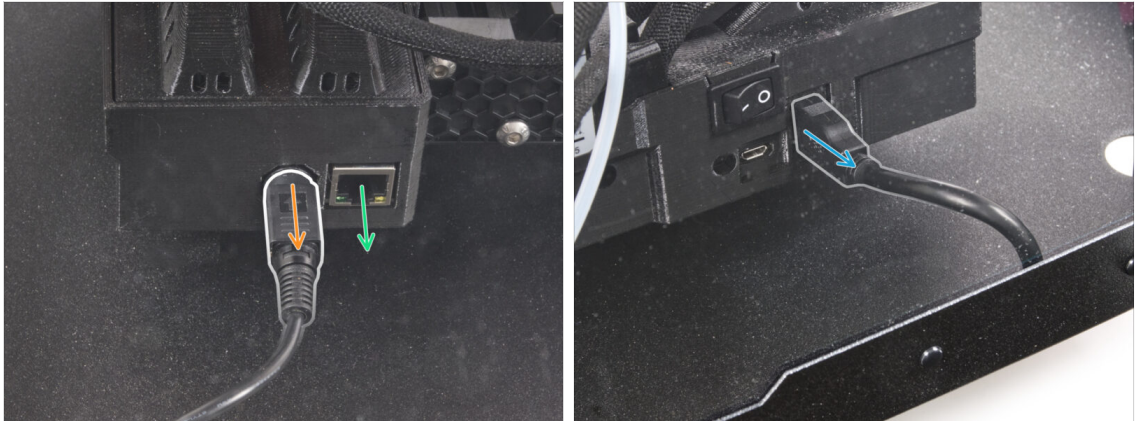

- Pull the power cord handle towards you to release and disconnect the power cord from the back of the printer.
- ⓘ If the space is difficult to access, move the printer closer to the front, **avoiding scratches on the panels.**
- If necessary, disconnect an ethernet cable.
- Disconnect the USB extension cable from the right side of the printer.

STEP 6 Uninstalling the printer

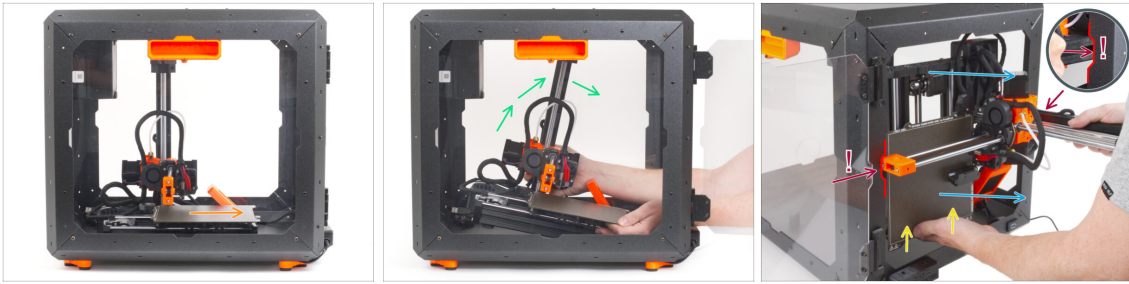

- From the front side of the MINI Enclosure:
- Move the heatbed towards you.
- Carefully take the printer.
- Carefully pull the printer out of the MINI Enclosure with the base facing backwards. **Be EXTRA CAREFUL when doing this:**
 - ⚠️ **Ensure the X-end and aluminum Z-axis profile pass through the right and left cutouts of the front opening. Use EXTRA CAUTION to avoid damaging the printer or enclosure.**
 - Hold the heatbed with your left hand to prevent it from sliding down and getting damaged on the bottom plate.
 - During pulling out the printer, look carefully at all sides of the printer to ensure that nothing is in the way (e.g., cables, motors, etc.).
 - ⚠️ **Ensure that no parts of the printer touch the side panels to avoid scratches.**
- Put the printer aside.

STEP 7 Advanced filtration system: parts preparation

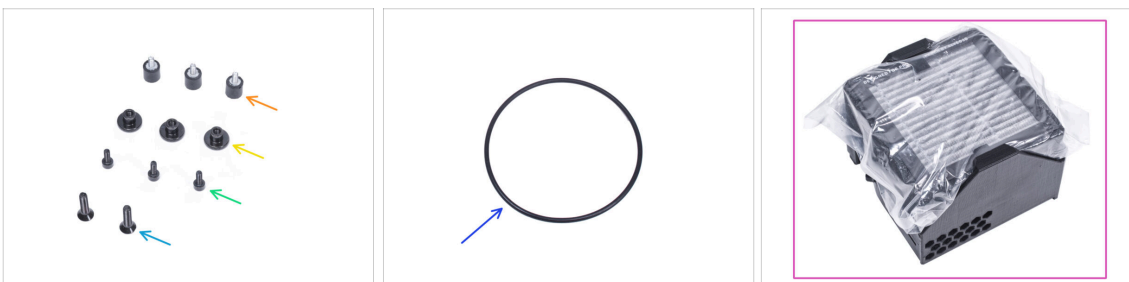

- For the following steps, please prepare:
- Damper (3x)
- Thumb nut M3 (3x)
- M3x8 screw (3x)
- M4x16b countersunk screw (2x)
- Blower o-ring (1x)
- Filtration pack (1x)

STEP 8 Assembling the filtration: parts preparation



- Push out the filter from the filtration pack and **divide the pack into these individual parts:**
- High Pressure Blower (1x)
- HEPA filter (1x)
- Filter-Bracket (1x)

STEP 9 Assembling the filtration

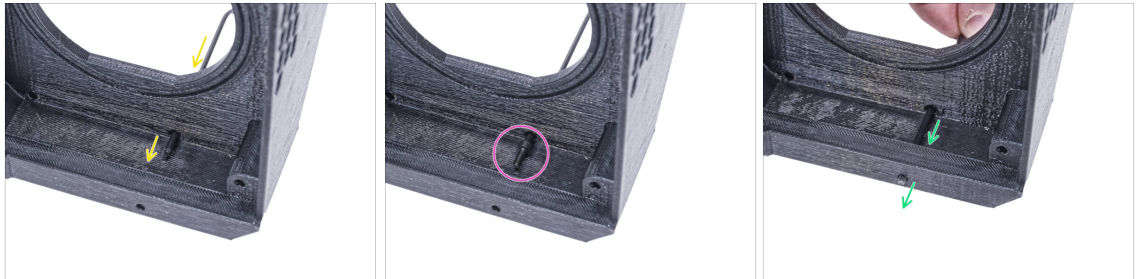

- Place the Filter-Bracket like in the picture and push the Allen key through the hole as you can see.
- Attach the M3x8 screw on the tip of the Allen key.
- Using the Allen key, push the screw all the way through the front hole of the bracket. The screw must protrude partially.

STEP 10 Assembling the filtration



- Tighten the damper on the screw.
- Repeat the same procedure to install the second damper.

STEP 11 Assembling the filtration



- Using the Allen key, push the M3x8 screw through the protrusion on the other side of the Filter-Bracket.
- ⚠ Leave the marked hole empty.
- Tighten the damper on the screw.

STEP 12 Installing the blower

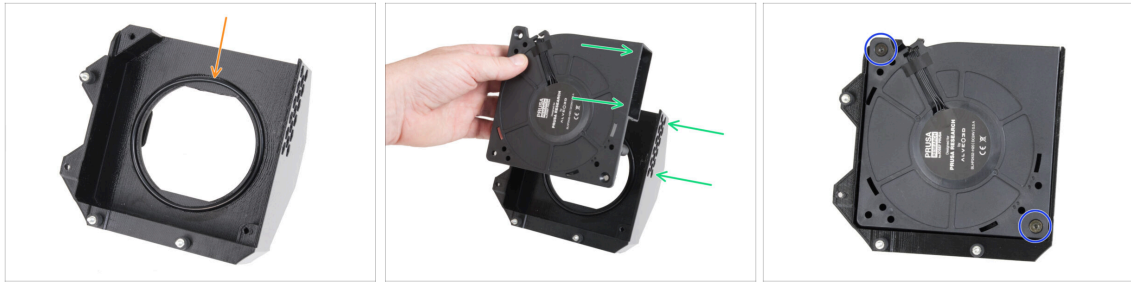

- Place the Blower o-ring into the Filter-Bracket.
- Insert the High Pressure Blower into the Filter-Bracket so that the blower of the fan faces the hexagonal holes in the printed part.
- Join both parts together with two M4x16b countersunk screws.

STEP 13 Inserting the HEPA filter



- Tear open the filter bag and remove the HEPA filter.
- Handle the filter with caution.** If the HEPA surface (the white pleated surface) is damaged, the filter will lose its efficiency. Protect your hands when you take off the used filter and put it in a plastic bag. A saturated filter is not recyclable.

STEP 14 Inserting the HEPA filter



- ◆ Orient the filtration assembly according to the picture. Make sure that two brackets are facing you and the cable is pointing to the left.
- ⚠ **Make sure that the HEPA filter is already removed from the bag.**
- ◆ From the left, push the HEPA filter all the way into the Filter-Bracket. Mind the orientation of the filter.

STEP 15 Installing the filtration



- ◆ From the inside, remove the nylon rivet on the left upper corner.
 - ⓘ Hint: use a Side cutters from inside the enclosure to push the nylon rivet out
- ◆ From the inside, attach the filtration to the rear side of the Enclosure "frame" so that all three screws go through the holes.
- ◆ Secure all three damper screws by tightening three thumb nuts.

STEP 16 Guiding the filtration cable: parts preparation



- For the following steps, please prepare:
- Zip tie (5x)

STEP 17 Guiding the add-on cables: filtration cable

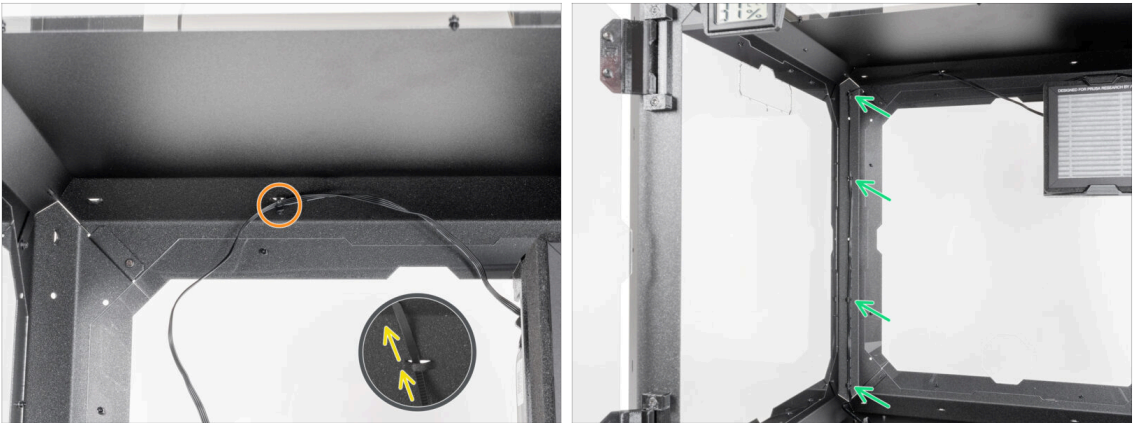

- Guide the zip tie through the perforation in the top panel near the filtration.
- Using this zip tie, secure the filtration cable. **Do not overtighten the zip tie**, as it may cause fatal damage to the cable.
- In the same way, secure the cable to the four perforations in the left rear profile. **Do not overtighten the zip ties**, as it may cause fatal damage to the cable.
- Leave the rest of the cable free for now.

STEP 18 PSU: parts preparation



i From October 2024 you may receive two different manufacturers of the PSU, the pictures may be different but **the assembly process is the same.**

For the following steps, please prepare:

- PSU (1x)**
- Zip tie (7x)**

STEP 19 Releasing the rear foot

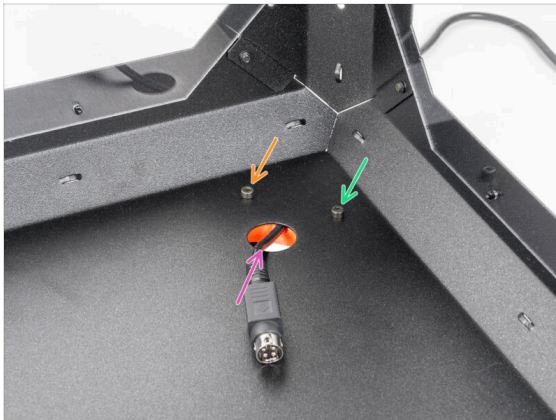

- Slightly loosen the left screw behind the circle hole.**
- Release and remove the right screw. Don't throw the screw away!**
- Remove the printer PSU cable from the rear hole.**
- Reposition the foot as shown in the picture. Keep the cable in the cable channel.**

STEP 20 Guiding the PSU cable

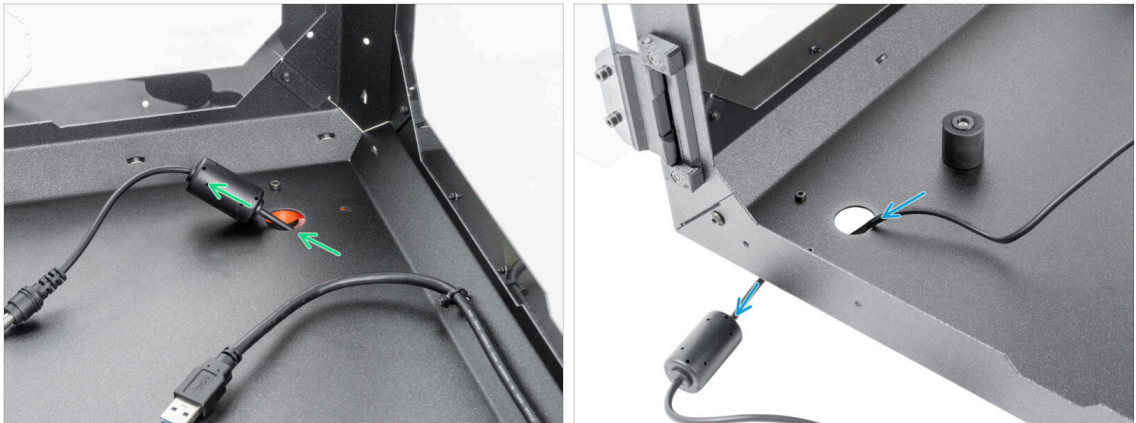

⚠ Exercise caution when handling anything inside the enclosure. There are sharp metal plates, so avoid injury.

➤ Insert the PSU cable with the ferrite core through the circular hole at the rear of the Enclosure.

i The ferrite core is smaller than the hole, slowly push it through the hole.

➤ Guide the PSU cable with the connector through the front circle hole out of the Enclosure.

STEP 21 Securing the rear foot



➤ Insert the printer PSU cable back through the rear hole.

➤ Close the foot back to its original position and align the holes in the foot and Enclosure.

i Tip: You can inspect the position through the Top window panel.

➤ After aligning the hole, secure the foot by inserting back the M3x12 screw.

➤ Fully tighten the left screw.

STEP 22 Releasing the front foot

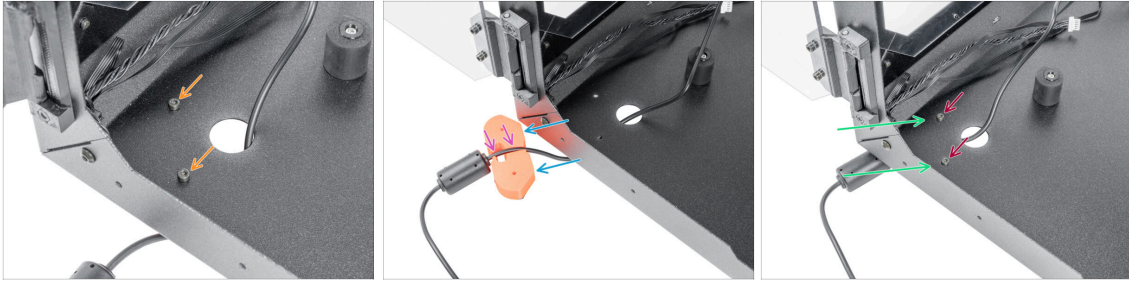

- Release and remove both M3x12 screws.
- Reposition the foot as shown. Push the PSU cable into the cable channel.
- Push the PSU cable into the cable channel.
- Close the foot back to its original position and align the holes.
- Secure the foot by inserting back the M3x12 screws and tighten them firmly.

STEP 23 Securing the PSU cable

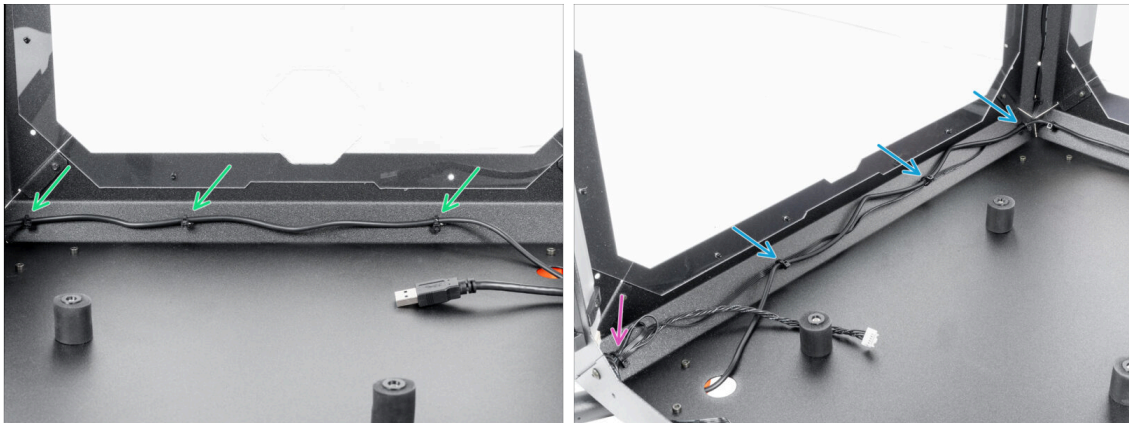

- ⚠ Exercise caution when handling anything inside the enclosure. There are sharp metal plates, so avoid injury.
- Guide the cable along the rear side of the Enclosure and secure it using three zip ties through the perforations. **Do not overtighten the zip ties, you can damage the cable.**
- Guide the PSU cable along with the FAN cable on the left side of the Enclosure and secure it with the three zip-ties. **Do not overtighten the zip ties, you can damage the cables.**
- If you have installed the Advanced Filtration System, guide the filtration cable together with the PSU cable. Secure it with one extra zip tie in the left corner. **Do not overtighten the zip tie, you can damage the cables.**

STEP 24 Basic Board: parts preparation



● For the following steps, please prepare:

- Basic Board Cover (1x)
- Basic board (1x)
- M3w serrated lock washer (2x)
- M3nS nut (2x)
- M3x12 screw (2x)

STEP 25 Installing the Basic Board



- Mount the M3nS nut on the M3x12 screw. Attach it in a few threads on the tip of the screw.
- Push the screw with the nut all the way into the same shape hole inside the Basic Board Cover.
- Remove the screw from the nut.

STEP 26 Installing the Basic Board

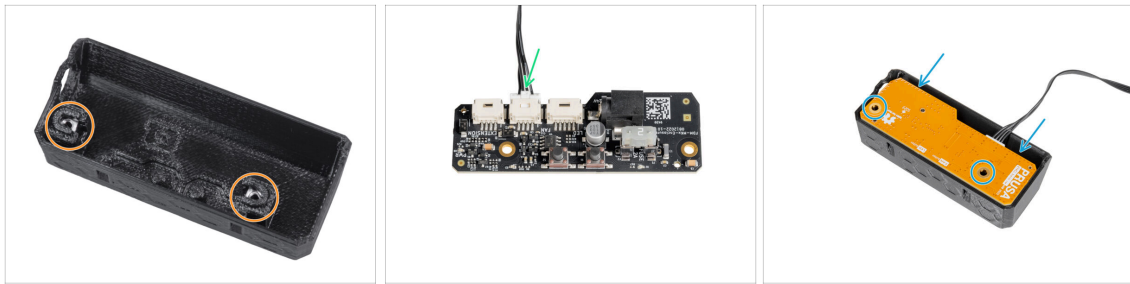

- 🟠 Use the same procedure for both slots in the Basic Board Cover.
- ⓘ If you already have an **LED strip panel** installed, leave the LED cable in the Basic board slot labeled LED.
- 🟢 Connect the filtration cable to the Basic Board slot labeled FAN.
- 🟡 Place the Basic Board into the Basic Board Cover and align the holes on both parts.

STEP 27 Mounting the Basic Board



- 🟠 From the inside the Enclosure, insert two M3x12 screw through the front profile.
- 🟢 Attach two M3w serrated lock washer on the screws.
- 🟡 Take the Basic Board assembly and align the holes with the screws in the profile.
- 🟣 Attach the Basic Board assembly to the screws and tighten the screws from the inside.

STEP 28 Connecting the Basic Board

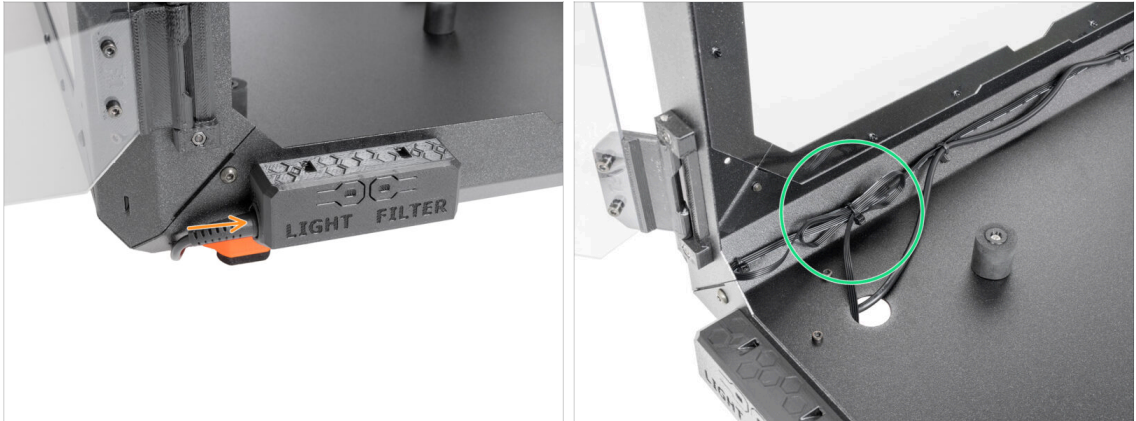

- Connect the external PSU cable to the basic board from the left side.
- It is recommended to make a loop with the excess cable and secure it with a zip tie. This way, the cable will not get in the way. **Do not overtighten the zip ties, you can damage the cable.**

STEP 29 PSU holder clarification (optional)



 These steps are only for LED strip and Advanced filtration system owners only. The smaller PSU space is for those with additional PSU. Otherwise, skip to **Door hinges: parts preparation**

PSU holder is not included in the package, you will need to print it out from [Printables.com](https://www.printables.com)

 **Before starting printing, check what type of PSU you have!**

- XP PSU: This PSU is larger than the Delta PSU. You will need the **Current-PSU-holder-XP, Add-on PSU-holder-A-XP and Add-on PSU-holder-B-XP.**
- Delta PSU: This PSU is smaller than the XP PSU. You will need the **Current-PSU-holder, Add-on PSU-holder-A and Add-on PSU-holder-B.**

STEP 30 PSU holder: parts preparation (optional)

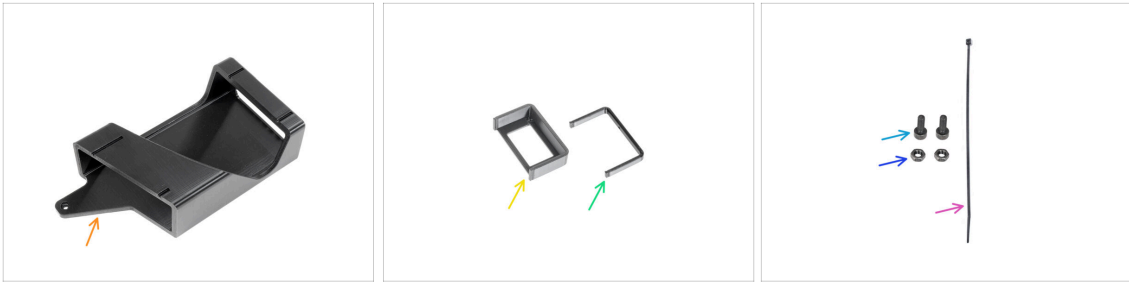

i These steps are only for LED strip and Advanced filtration system owners only. The smaller PSU space is for those with additional Delta PSU. Otherwise, skip to **Installing the printer**

For the next steps, please prepare:

- PSU-holder (1x) *this part is not included in the package, you will need to print it out from [Printables.com](https://www.printables.com)*
- Add-on PSU-holder-A (1x) *this part is not included in the package, you will need to print it out from [Printables.com](https://www.printables.com)*
- Add-on PSU-holder-B (1x) *this part is not included in the package, you will need to print it out from [Printables.com](https://www.printables.com)*
- M3x8 screw (2x)
- M3n nut (2x)
- Zip-tie (1x)

STEP 31 PSU holder nut preparation (optional)

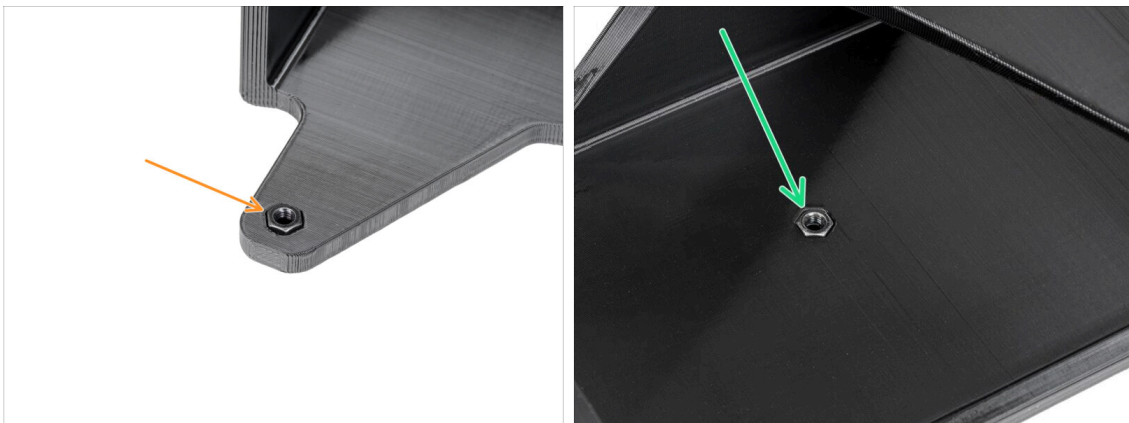

- Insert the M3n nut into the PSU-holder.
- Insert the M3n nut into the PSU-holder.

STEP 32 PSU holder preparation (optional)

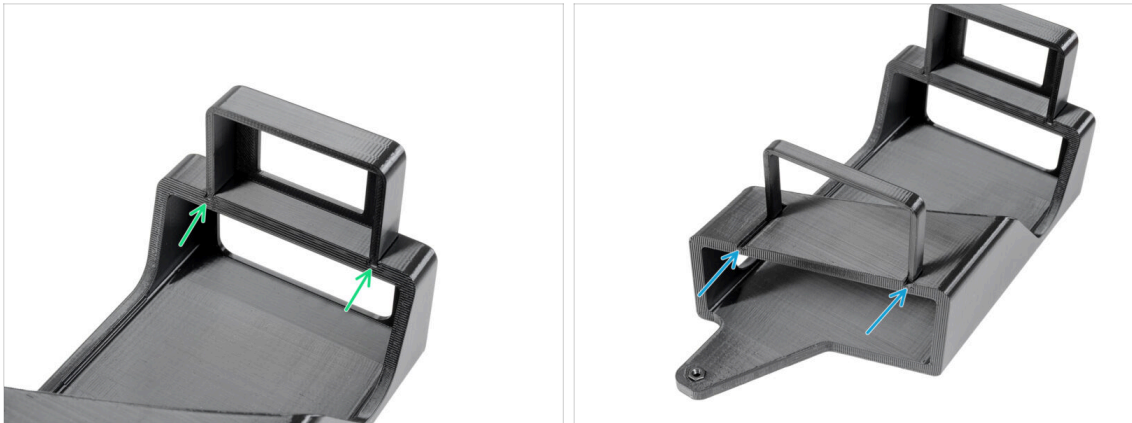

i These steps are only for LED strip and Advanced filtration system owners only. The smaller PSU space is for those with additional Delta PSU.

- Attach the Add-on PSU-holder-A to the rails on the PSU-holder.
- Attach the Add-on PSU-holder-B to the rails on the PSU-holder.

STEP 33 Attaching the PSU holder (optional)



- Remove the nylon rivet on the left bottom corner.
 - i** Hint: use a pliers from inside the enclosure to push the nylon rivet out
- From the inside of the enclosure, insert two M3x8 screws through the cut-outs.
- Attach the PSU-holder on the screws.
- Secure the screws from the inside.

STEP 34 Securing the PSUs (optional)



- ◆ Insert the printer PSU into the PSU-holder.
- ◆ Insert the add-on PSU into the PSU-holder.
- ◆ Secure the cables together with a zip-tie.

STEP 35 Installing the printer

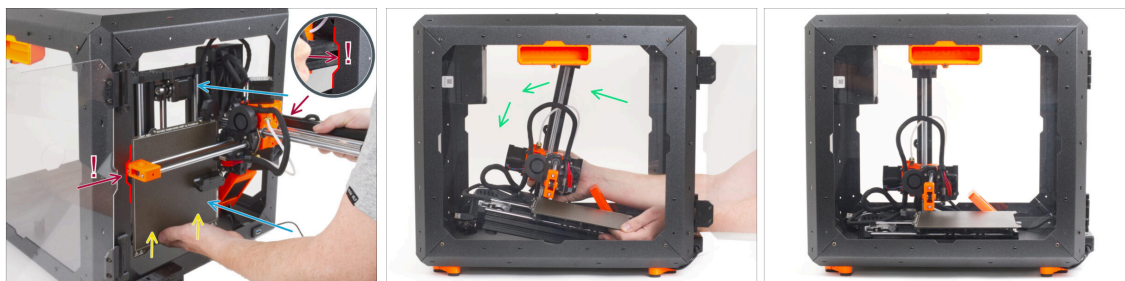

- ◆ Carefully insert the printer inside the enclosure with its base facing forward. **When doing so, be EXTRA CAREFUL to:**
 - ⚠ **Ensure the X-end and aluminum Z-axis profile pass through the right and left cutouts of the front opening. Use EXTRA CAUTION to avoid damaging the printer or enclosure.**
 - ◆ **Hold the heatbed with your left hand to prevent it from sliding down and getting damaged on the bottom plate.**
 - ◆ **During insertion, carefully watch all sides of the printer to ensure nothing is in the way (e.g., cables, motors, etc.).**
- ◆ Carefully place the printer on its feet. We will adjust the exact position later on.
 - ⚠ **Ensure that no parts of the printer touch the side panels to avoid scratches.**

STEP 36 Adjusting printer position

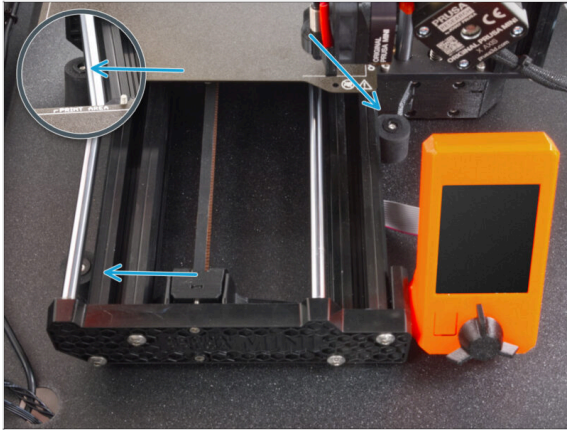

- Rearrange position of the printer like in the picture. The **printer must be placed between all three anti-slip dampers.**

STEP 37 Connecting the cables

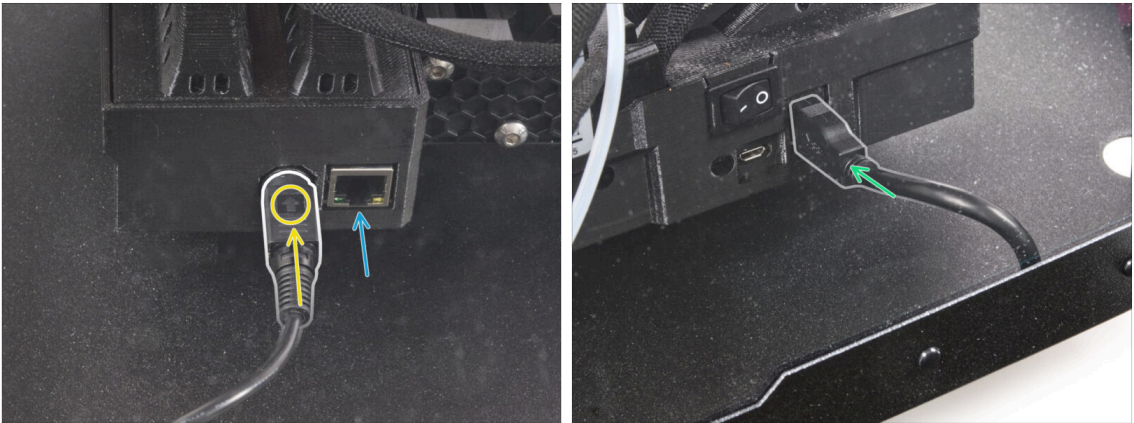

- From the back of the printer, connect the PSU power cable. See the correct orientation of the cable.
 - ⓘ If the space is difficult to access, move the printer closer to the front, **avoiding scratches on the panels.**
- If necessary, connect an ethernet cable, which is optional.
- Connect the USB extension cable from the right side of the printer.

STEP 38 Mounting the side arm



- Insert the side arm into the Spool-holder-r and turn counter-clockwise to lock it.

STEP 39 Connecting the cables

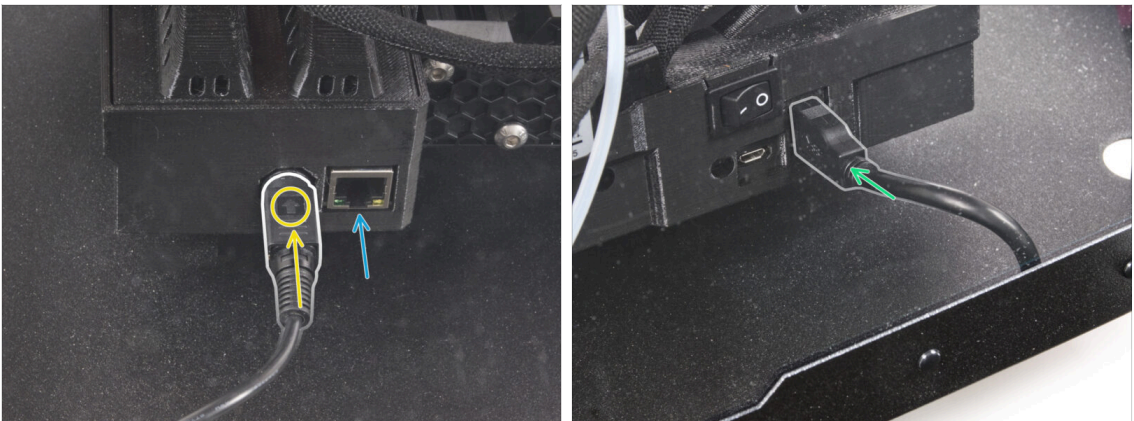

- From the back of the printer, connect the PSU power cable. See the correct orientation of the cable.
 - ⓘ If the space is difficult to access, move the printer closer to the front, **avoiding scratches on the panels.**
- If necessary, connect an ethernet cable, which is optional.
- Connect the USB extension cable from the right side of the printer.

STEP 40 Connecting the PSUs: parts preparation



- ◆ For the next steps, please prepare:
- ◆ Power cord Y-splitter (1x)

STEP 41 Connecting the PSUs

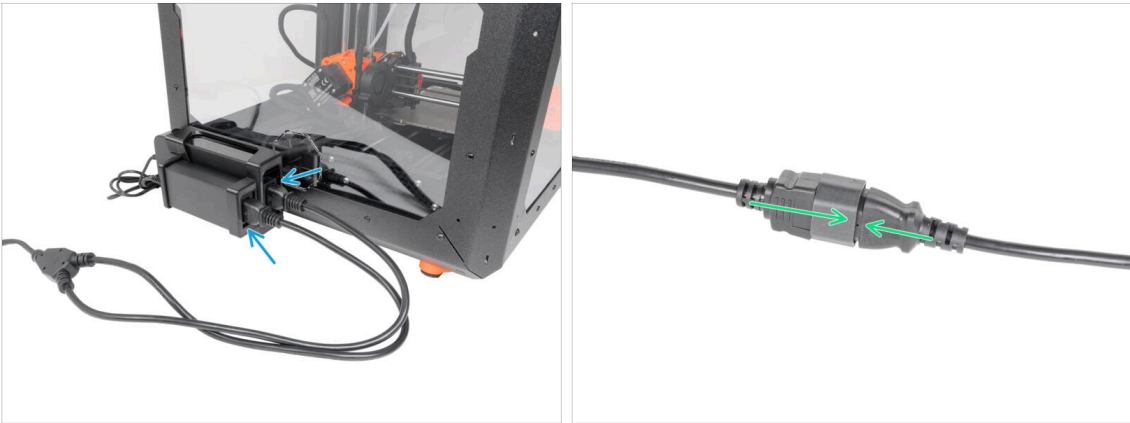

- ◆ Connect the plug ends to the PSUs.
- ◆ Connect the second end of the power cord Y-splitter to the power cable.

STEP 42 That's it

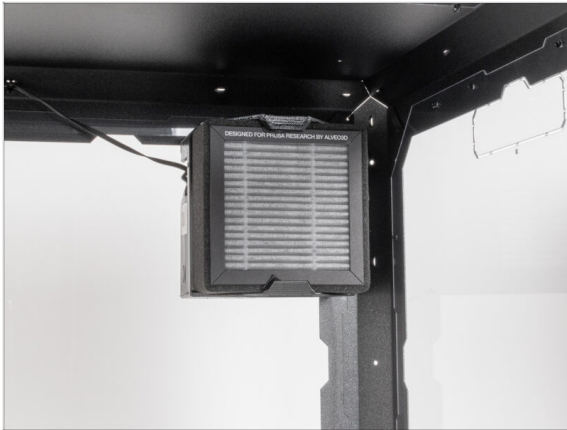

- ◆ That's it! Well done. You have successfully installed the Advanced filtration system in your Original Prusa MINI Enclosure. Now let's put it to the test.
- ◆ On the Basic board cover, press the *FILTER* button.

White LED strip (add-on)



STEP 1 Tools necessary for this chapter

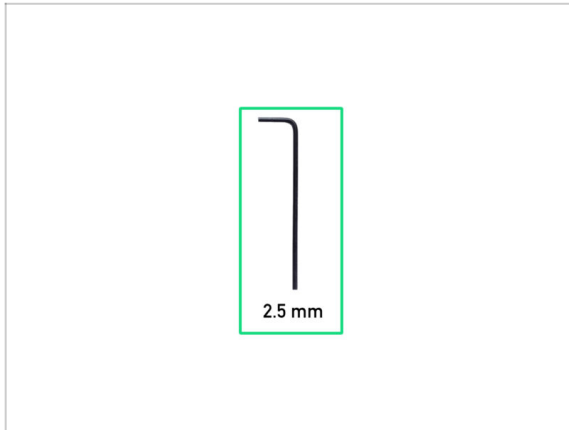

- For this chapter, please prepare:
- 2.5mm Allen key

STEP 2 Additional tools



- ⓘ Tools that are not included but can make assembly easier, especially when installing add-ons.
- Additional tools:
- Side cutters *for cutting zip ties and removing the nylon rivets*

STEP 3 Optional parts

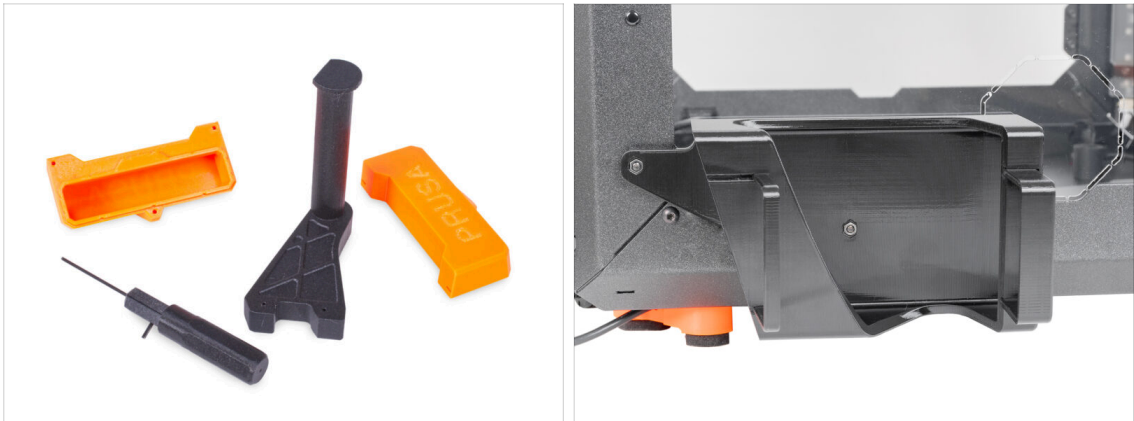

- We have designed enhancements that are not shipped by default in the kit, but you can print them out and add them to the enclosure during assembly. Fasteners are already included in the kit.

⚠ **Print out the parts before you start assembly.**

- To see the full list of the parts, please visit our collection at [Printables.com](https://www.praprusa.com/3d-printed-parts).

STEP 4 Removing the side arm



- Grasp the Spool-holder-r and turn clockwise to unlock it and remove it from the MINI Enclosure.

STEP 5 Disconnecting the cables

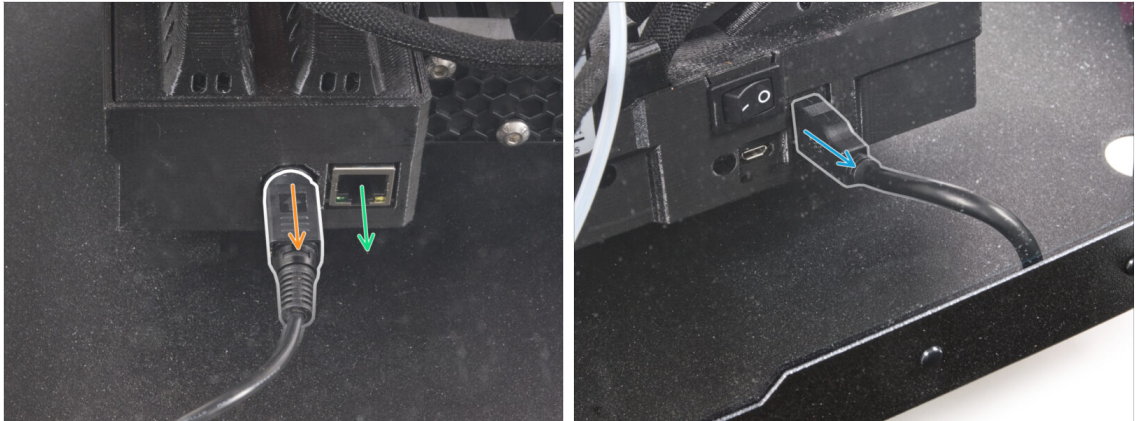

- Pull the power cord handle towards you to release and disconnect the power cord from the back of the printer.
- ⓘ If the space is difficult to access, move the printer closer to the front, **avoiding scratches on the panels.**
- If necessary, disconnect an ethernet cable.
- Disconnect the USB extension cable from the right side of the printer.

STEP 6 Uninstalling the printer

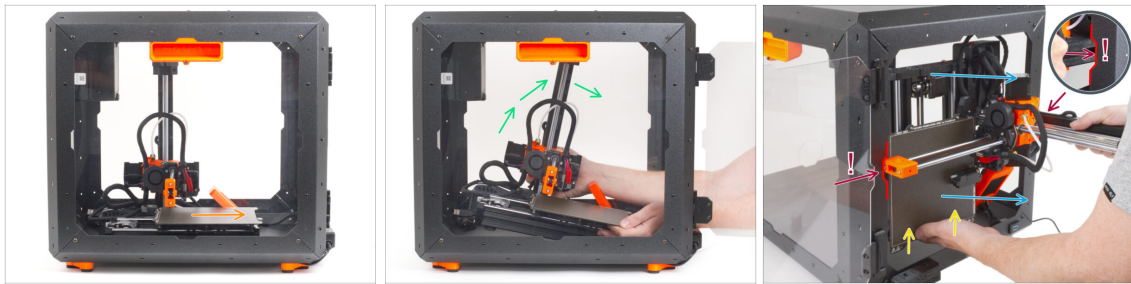

- From the front side of the MINI Enclosure:
- Move the heatbed towards you.
- Carefully take the printer.
- Carefully pull the printer out of the MINI Enclosure with the base facing backwards. **Be EXTRA CAREFUL when doing this:**
 - ⚠️ **Ensure the X-end and aluminum Z-axis profile pass through the right and left cutouts of the front opening. Use EXTRA CAUTION to avoid damaging the printer or enclosure.**
 - Hold the heatbed with your left hand to prevent it from sliding down and getting damaged on the bottom plate.
 - During pulling out the printer, look carefully at all sides of the printer to ensure that nothing is in the way (e.g., cables, motors, etc.).
 - ⚠️ **Ensure that no parts of the printer touch the side panels to avoid scratches.**
- Put the printer aside.

STEP 7 Delta PSU: parts preparation

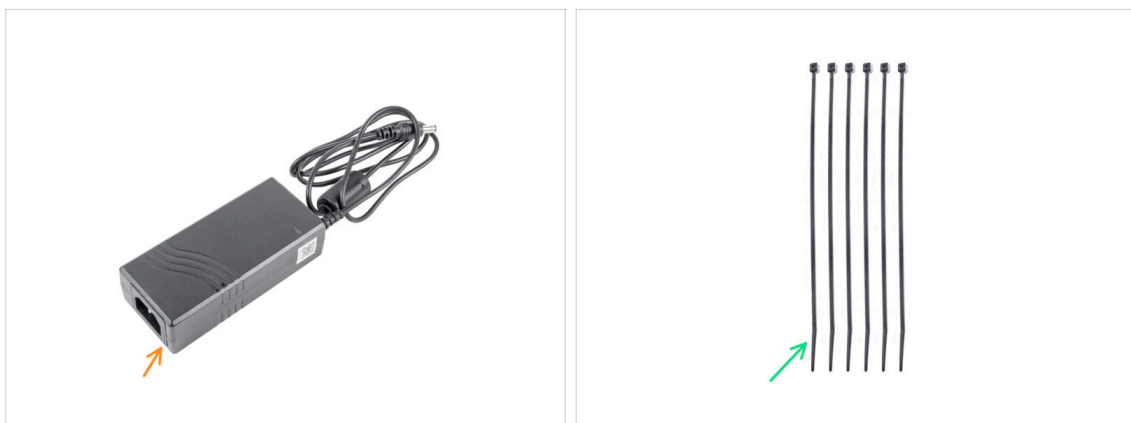

- ⓘ From October 2024 you may receive two different manufacturers of the PSU, the pictures may be different but **the assembly process is the same.**
- **For the following steps, please prepare:**
 - PSU (1x)
 - Zip tie (6x)

STEP 8 Releasing the rear foot

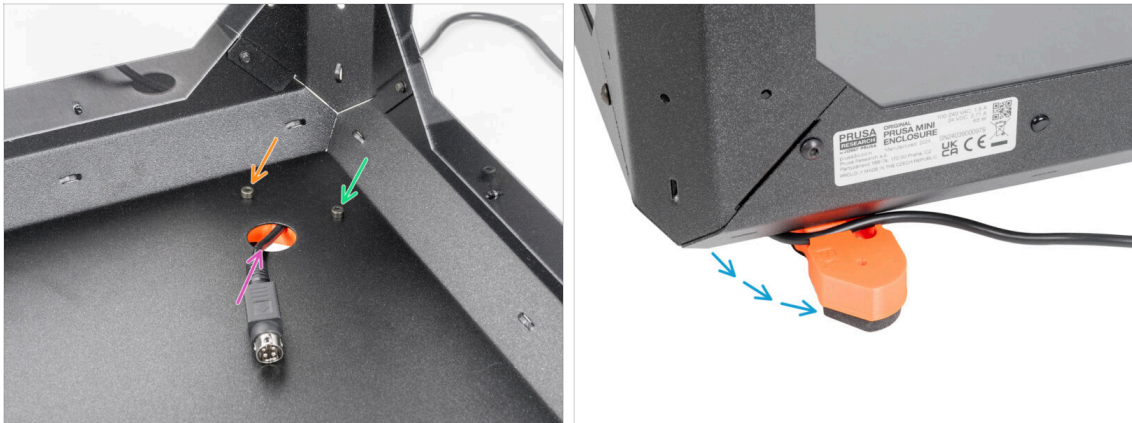

- 🟠 Slightly loosen the left screw behind the circle hole.
- 🟢 Release and remove the right screw. **Don't throw the screw away!**
- 🟡 Remove the printer PSU cable from the rear hole.
- 🟠 Reposition the foot as shown in the picture. **Keep the cable in the cable channel.**

STEP 9 Guiding the PSU cable

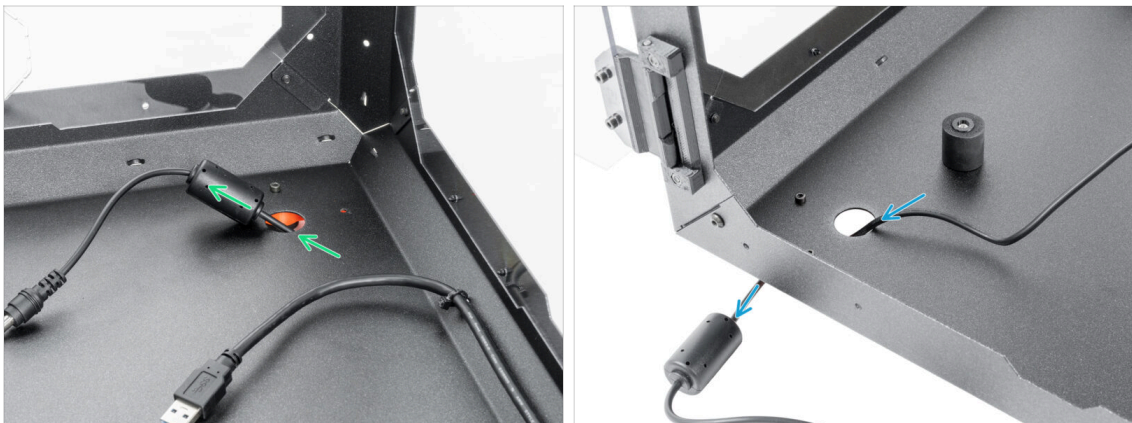

- ⚠️ Exercise caution when handling anything inside the enclosure. There are sharp metal plates, so avoid injury.
- 🟢 Insert the PSU cable with the ferrite core through the circular hole at the rear of the Enclosure.
- 📄 The ferrite core is smaller than the hole, slowly push it through the hole.
- 🟠 Guide the PSU cable with the connector through the front circle hole out of the Enclosure.

STEP 10 Securing the rear foot



- ◆ Insert the printer PSU cable back through the rear hole.
- ◆ Close the foot back to its original position and align the holes in the foot and Enclosure.
- ⓘ Tip: You can inspect the position through the Top window panel.
- ◆ After aligning the hole, secure the foot by inserting back the M3x12 screw.
- ◆ Fully tighten the left screw.

STEP 11 Releasing the front foot

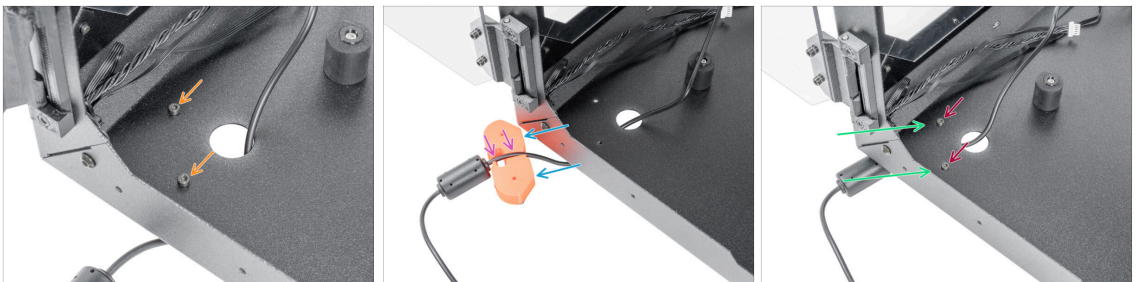

- ◆ Release and remove both M3x12 screws.
- ◆ Reposition the foot as shown. Push the PSU cable into the cable channel.
- ◆ Push the PSU cable into the cable channel.
- ◆ Close the foot back to its original position and align the holes.
- ◆ Secure the foot by inserting back the M3x12 screws and tighten them firmly.

STEP 12 Securing the PSU cable

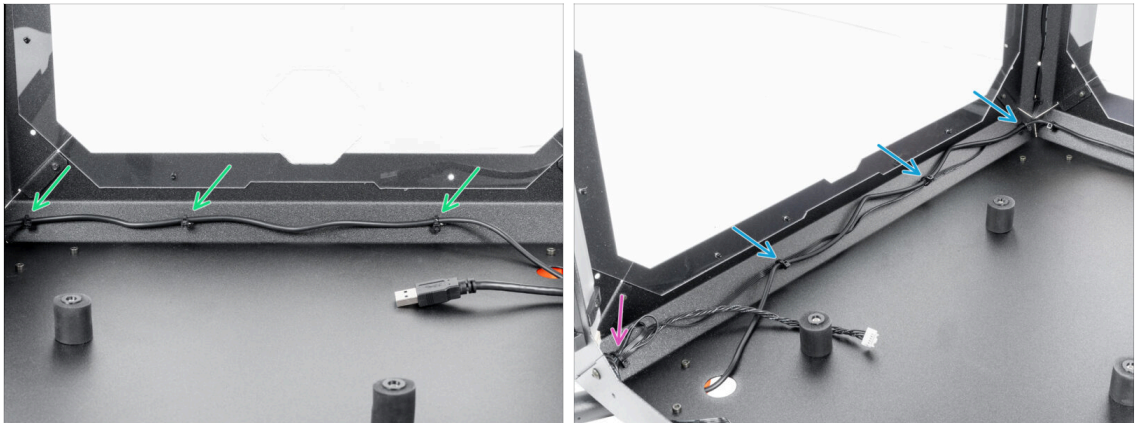

⚠ Exercise caution when handling anything inside the enclosure. There are sharp metal plates, so avoid injury.

- 🟢** Guide the cable along the rear side of the Enclosure and secure it using three zip ties through the perforations. **Do not overtighten the zip ties, you can damage the cable.**
- 🟡** Guide the PSU cable along with the FAN cable on the left side of the Enclosure and secure it with the three zip-ties. **Do not overtighten the zip ties, you can damage the cables.**
- 🟣** If you have installed the Advanced Filtration System, guide the filtration cable together with the PSU cable. Secure it with one extra zip tie in the left corner. **Do not overtighten the zip tie, you can damage the cables.**

STEP 13 White LED strip: parts preparation



🛠 For the following steps, please prepare:

- 🟡** LED Stick Board (1x)
WARNING: Make sure to protect the electronics against electrostatic discharge (ESD). Always unpack the electronics right before you need them!
- 🟢** LED diffuser (1x)
- 🟡** LED Stick Bracket (3x)
- 🟢** M3x18 screw (3x)
- 🟣** M3n nut (3x)

STEP 14 Assembling the LED strip

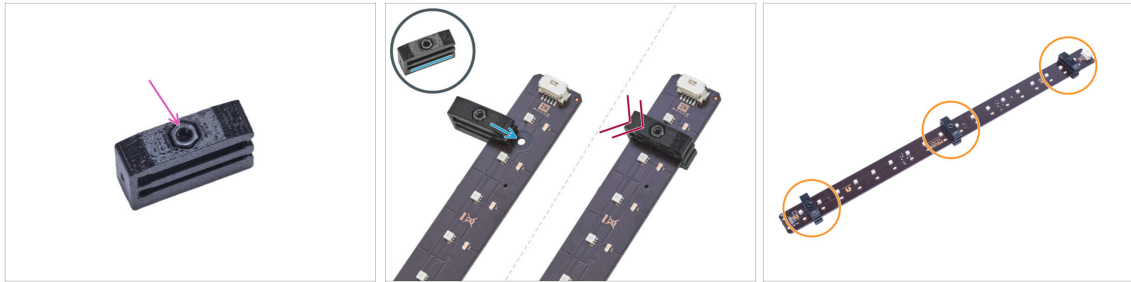

- ◆ Insert the M3n nut into each LED Stick Bracket.
 - ⚠ **The nut must be completely embedded in the printed part and flush with the surface of the part. Insufficient embedment of the nut can cause problems when mounting in the enclosure.**
- ◆ Slide the lower slot of the LED Stick Bracket on the LED Stick Board and align the bracket against the first hole in the LED Stick Board closest to the (white) LED stick connector.
 - ⚠ **Avoid sliding the bracket over chips and diodes! It can be fatally damaged.**
- ◆ Push the LED Stick Bracket all the way on the LED Stick Board.
- ◆ Use this procedure for all three LED Stick Brackets.

STEP 15 Assembling the LED strip

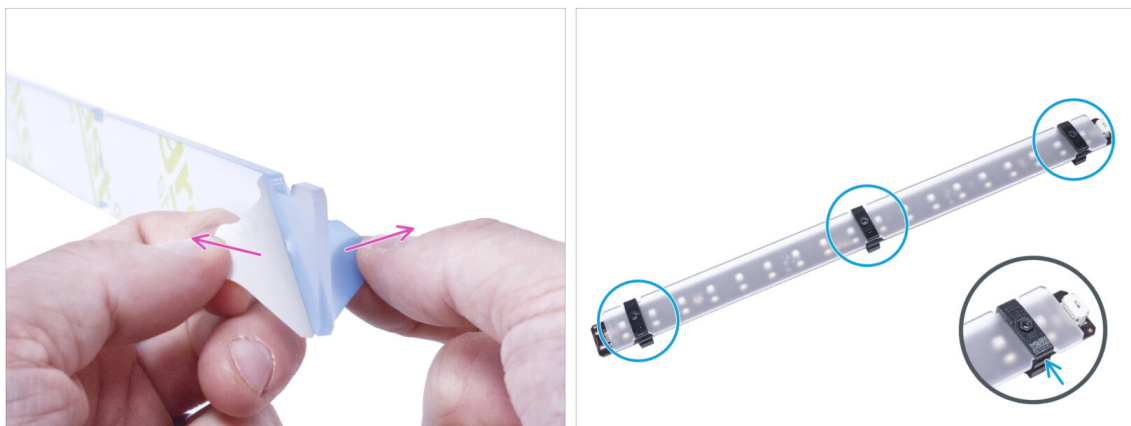

- ◆ Remove the protection films from both sides of the LED diffuser.
- ◆ Push the LED diffuser into the LED Stick Brackets. Use the upper slot.
 - ⓘ The orientation of the LED diffuser doesn't matter. The part is symmetrical.

STEP 16 Mounting the LED strip



- i From now on, we will demonstrate LED mounting on the printer without the door panel for better visibility. **Please note, do not remove the door panel from your printer.** The printer in the pictures will be shown without door panel for improved visualization for the customers.
- From the inside of the enclosure, attach the LED strip assembly so that the LED stick brackets are aligned precisely with the screws. Attach the back side (the side without the diffuser).
- ⚠ **Make sure, the LED connector is facing down.**
- Secure the LED panel from the outside of the frame with three M3x18 screws. **Tighten them firmly but gently.**

STEP 17 LED cable: parts preparation

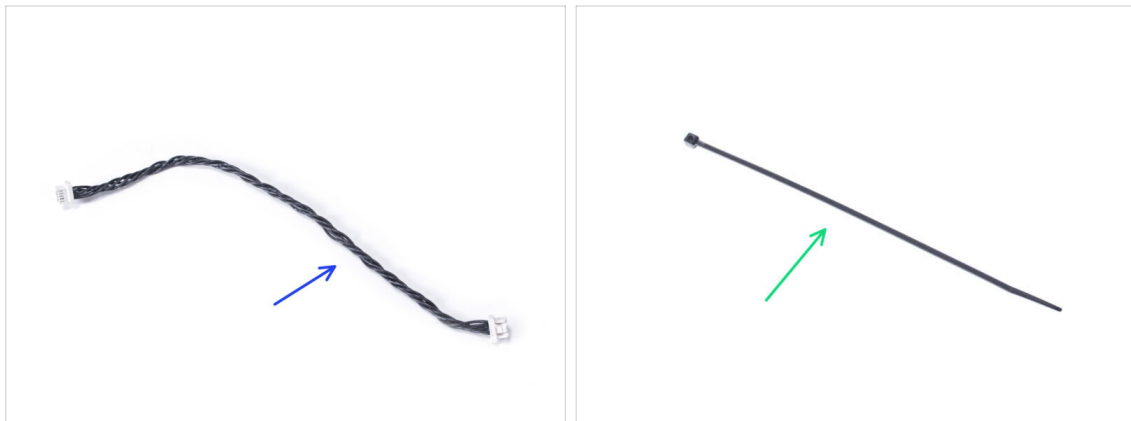

- **For the following steps, please prepare:**
- LED cable (1x)
- Zip tie (1x)

STEP 18 Guiding the LED cable

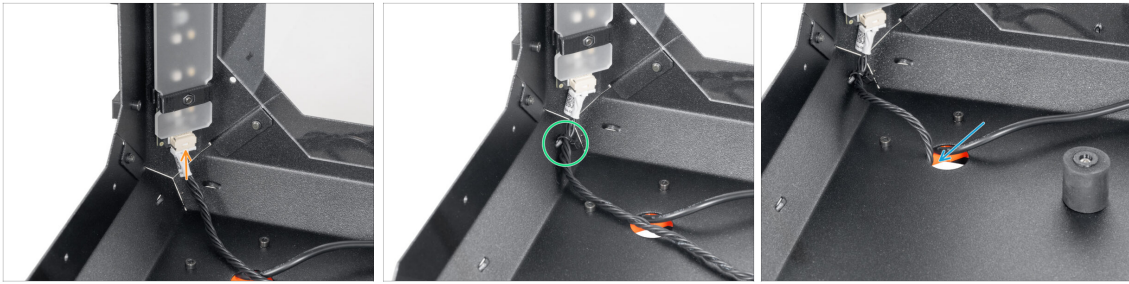

- 🟠 Connect the LED cable to the connector on the bottom of the LED strip.
- 🟢 Guide the zip tie through the perforation in the front left profile and secure the LED cable using the zip tie. **Do not overtighten the zip-tie.**
- 🟡 Guide the LED cable through the hole in the bottom panel out of the MINI Enclosure.

STEP 19 Basic Board: parts preparation



- 🛑 **For the following steps, please prepare:**
- 🟠 Basic Board Cover (1x)
 - 🟢 Basic board (1x)
 - 🟡 M3w serrated lock washer (2x)
 - 🟡 M3nS nut (2x)
 - 🟡 M3x12 screw (2x)

STEP 20 Installing the Basic Board



- Mount the M3nS nut on the M3x12 screw. Attach it in a few threads on the tip of the screw.
- Push the screw with the nut all the way into the same shape hole inside the Basic Board Cover.
- Remove the screw from the nut.

STEP 21 Installing the Basic Board

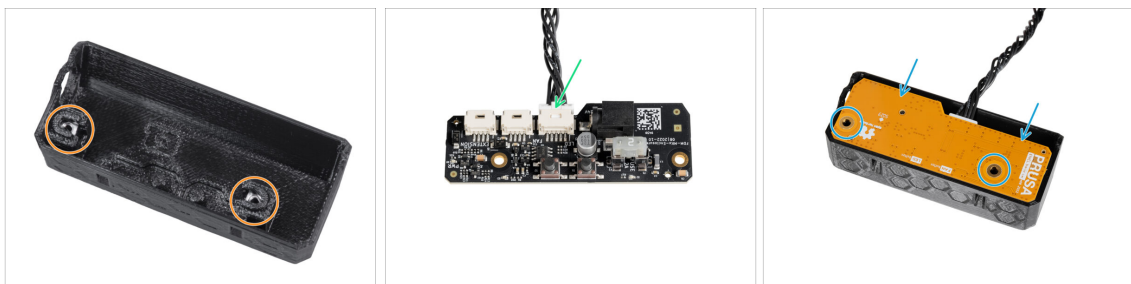

- Use the same procedure for both slots in the Basic Board Cover.
- ⓘ If you already have an **Advanced filtration system** installed, leave the filtration cable in the Basic board slot labeled FAN.
- Connect the LED cable to the Basic Board slot labeled LED.
- Place the Basic Board into the Basic Board Cover and align the holes on both parts.

STEP 22 Mounting the Basic Board



- From the inside the Enclosure, insert two M3x12 screw through the front profile.
- Attach two M3w serrated lock washer on the screws.
- Take the Basic Board assembly and align the holes with the screws in the profile.
- Attach the Basic Board assembly to the screws and tighten the screws from the inside.

STEP 23 Connecting the Basic Board



- Connect the external PSU cable to the basic board from the left side.

STEP 24 PSU holder clarification (optional)



 These steps are only for LED strip and Advanced filtration system owners only. The smaller PSU space is for those with additional PSU. Otherwise, skip to **Door hinges: parts preparation**

 PSU holder is not included in the package, you will need to print it out from [Printables.com](https://www.printables.com)

 **Before starting printing, check what type of PSU you have!**

 XP PSU: This PSU is larger than the Delta PSU. You will need the **PSU-holder-XP**.

 Delta PSU: This PSU is smaller than the XP PSU. You will need the **PSU-holder-Delta**.

STEP 25 PSU holder: parts preparation (optional)

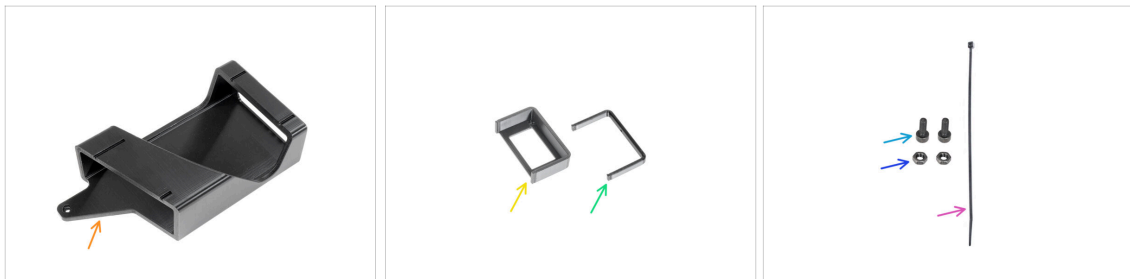



 These steps are only for LED strip and Advanced filtration system owners only. The smaller PSU space is for those with additional Delta PSU. Otherwise, skip to **Installing the printer**

 **For the next steps, please prepare:**

 PSU-holder (1x) *this part is not included in the package, you will need to print it out from [Printables.com](https://www.printables.com)*

 Add-on PSU-holder-A (1x) *this part is not included in the package, you will need to print it out from [Printables.com](https://www.printables.com)*

 Add-on PSU-holder-B (1x) *this part is not included in the package, you will need to print it out from [Printables.com](https://www.printables.com)*

 M3x8 screw (2x)

 M3n nut (2x)

 Zip-tie (1x)

STEP 26 PSU holder nut preparation (optional)

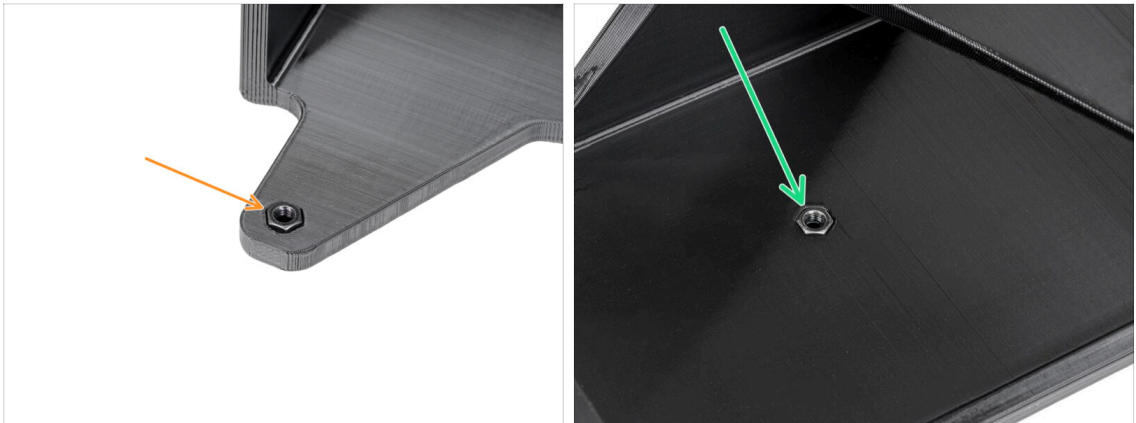

- Insert the M3n nut into the PSU-holder.
- Insert the M3n nut into the PSU-holder.

STEP 27 PSU holder preparation (optional)



- ⓘ These steps are only for LED strip and Advanced filtration system owners only. The smaller PSU space is for those with additional Delta PSU.
- Attach the Add-on PSU-holder-A to the rails on the PSU-holder.
- Attach the Add-on PSU-holder-B to the rails on the PSU-holder.

STEP 28 Attaching the PSU holder (optional)



- 🟠 Remove the nylon rivet on the left bottom corner.
 - 📄 Hint: use a Side cutters from inside the enclosure to push the nylon rivet out
- 🟢 From the inside of the enclosure, insert two M3x8 screws through the cut-outs.
- 🟢 Attach the PSU-holder on the screws.
- 🟡 Secure the screws from the inside.

STEP 29 Securing the PSUs (optional)



- 🟢 Insert the printer PSU into the PSU-holder.
- 🟠 Insert the add-on PSU into the PSU-holder.
- 🟢 Secure the cables together with a zip-tie.

STEP 30 Installing the printer

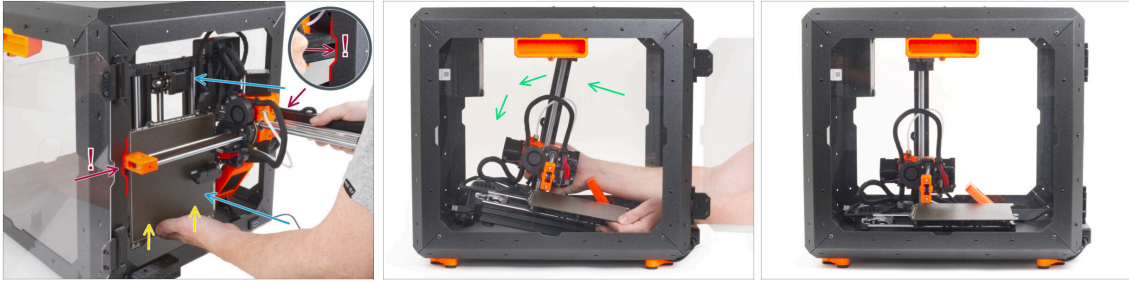

- ◆ Carefully insert the printer inside the enclosure with its base facing forward. **When doing so, be EXTRA CAREFUL to:**
 - ⚠ **Ensure the X-end and aluminum Z-axis profile pass through the right and left cutouts of the front opening. Use EXTRA CAUTION to avoid damaging the printer or enclosure.**
 - ◆ **Hold the heatbed with your left hand to prevent it from sliding down and getting damaged on the bottom plate.**
 - ◆ **During insertion, carefully watch all sides of the printer to ensure nothing is in the way (e.g., cables, motors, etc.).**
- ◆ Carefully place the printer on its feet. We will adjust the exact position later on.
 - ⚠ **Ensure that no parts of the printer touch the side panels to avoid scratches.**

STEP 31 Adjusting printer position

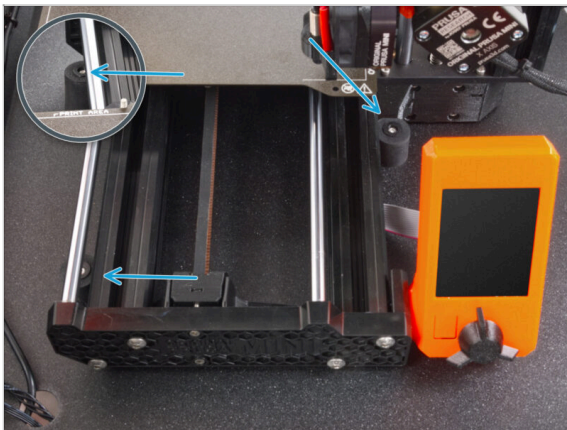

- ◆ Rearrange position of the printer like in the picture. The **printer must be placed between all three anti-slip dampers.**

STEP 32 Connecting the cables

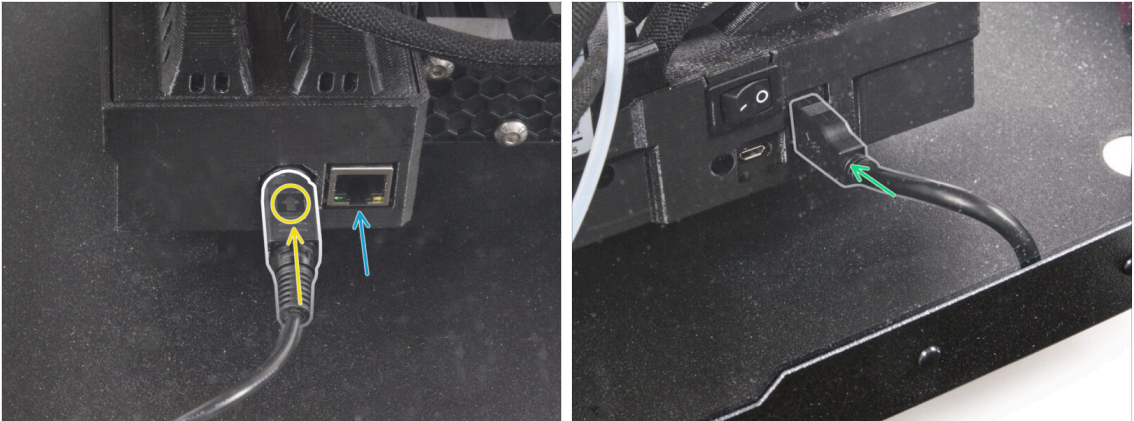

- From the back of the printer, connect the PSU power cable. See the correct orientation of the cable.
 - ⓘ If the space is difficult to access, move the printer closer to the front, **avoiding scratches on the panels**.
- If necessary, connect an ethernet cable, which is optional.
- Connect the USB extension cable from the right side of the printer.

STEP 33 Mounting the side arm



- Insert the side arm into the Spool-holder-r and turn counter-clockwise to lock it.

STEP 34 That's it



- ◆ That's it! Well done. You have successfully installed the LED panel in your Original Prusa MINI Enclosure. Now let's put it to the test.
- ◆ On the Basic board cover, press the *LIGHT* button.

Fire Suppression System (add-on)



STEP 1 Tools necessary for this chapter

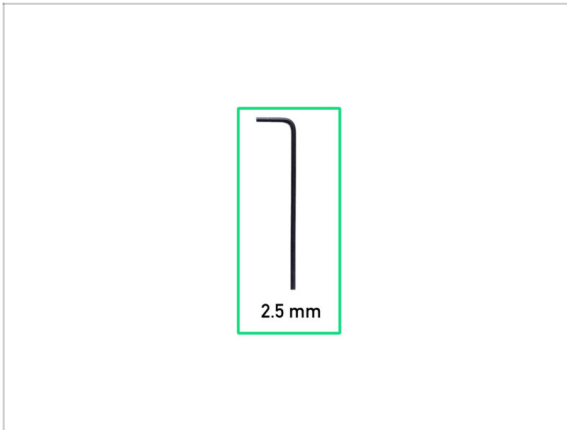

- For this chapter, please prepare:
- 2.5mm Allen key

STEP 2 Removing the side arm



- Grasp the Spool-holder-r and turn clockwise to unlock it and remove it from the MINI Enclosure.

STEP 3 Disconnecting the cables

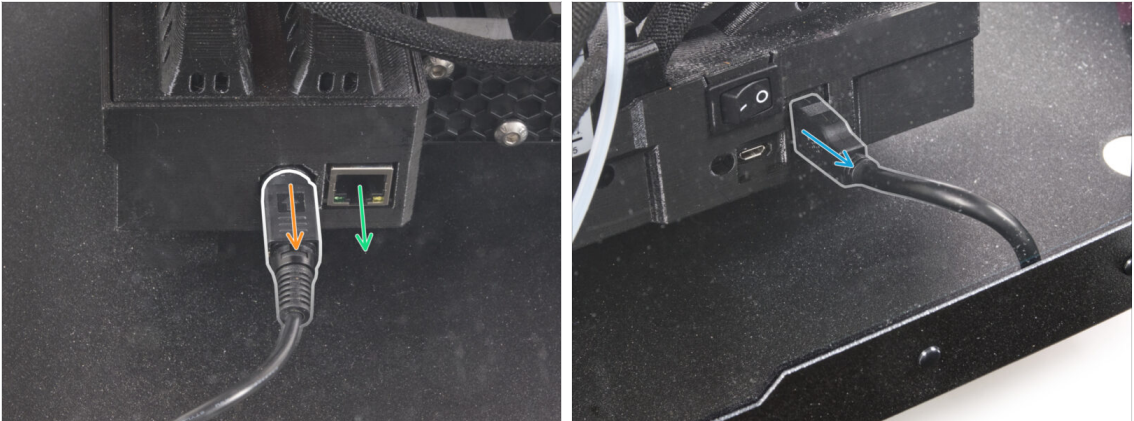

- Pull the power cord handle towards you to release and disconnect the power cord from the back of the printer.
- ⓘ If the space is difficult to access, move the printer closer to the front, **avoiding scratches on the panels**.
- If necessary, disconnect an ethernet cable.
- Disconnect the USB extension cable from the right side of the printer.

STEP 4 Uninstalling the printer

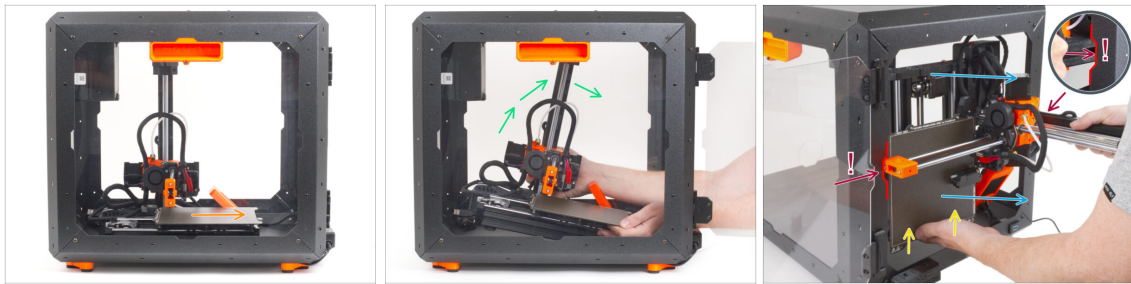

- From the front side of the MINI Enclosure:
- Move the heatbed towards you.
- Carefully take the printer.
- Carefully pull the printer out of the MINI Enclosure with the base facing backwards. **Be EXTRA CAREFUL when doing this:**
 - ⚠️ **Ensure the X-end and aluminum Z-axis profile pass through the right and left cutouts of the front opening. Use EXTRA CAUTION to avoid damaging the printer or enclosure.**
 - Hold the heatbed with your left hand to prevent it from sliding down and getting damaged on the bottom plate.
 - During pulling out the printer, look carefully at all sides of the printer to ensure that nothing is in the way (e.g., cables, motors, etc.).
 - ⚠️ **Ensure that no parts of the printer touch the side panels to avoid scratches.**
- Put the printer aside.

STEP 5 Fire suppression system: parts preparation



- For the following steps, please prepare:
- P-clamp (2x)
- M3 nut assembly (2x) *the nut with the M3x12 screw*
- Fire suppression system tube (1x) *type: T033E BlazeCut T Series Fire Suppression 1 System with a pressure gauge*
- ⚠️ **Handle the tube carefully to avoid damage.**

STEP 6 Mounting the P-clamp

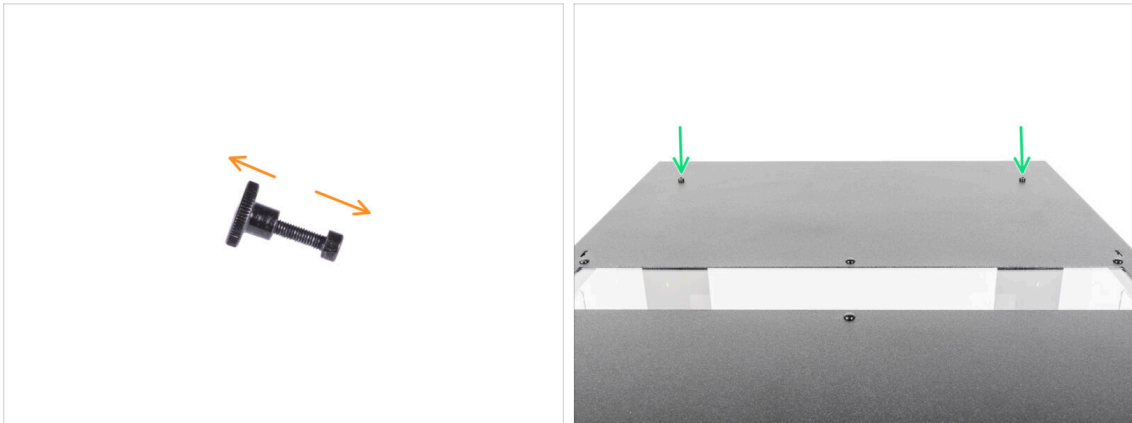

- 🟠 Unscrew both M3x12 screws from the nuts.
- 🟢 Locate two holes on the rear side of the top panel and insert the M3x12 screws into both holes.

STEP 7 Mounting the P-clamp



- 🟠 From the inside, locate the inserted M3x12 screws on the right side of the top panel.
- 🟢 Insert the nut into the P-clamp. See the correct orientation of both parts.
- 🟡 Attach the nut in the P-clamp to the M3x12 screw in the top panel. Tighten the screw using the Allen key from the top with your other hand. **Do not tighten the screw now!** A few turns are enough. We will tighten it later.

STEP 8 Installing the automatic suppression system

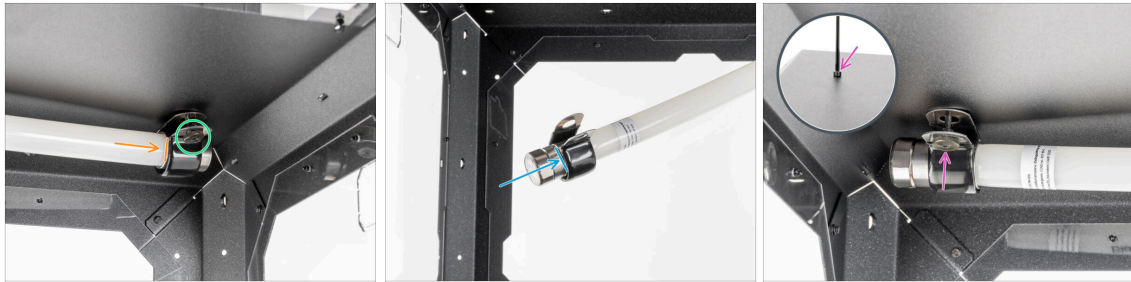

- ✦ Insert the metal end of the tube into the P-clamp.
 - ⓘ If it is difficult to insert the tube into the P-clamp, loosen the nut a little. **But be careful not to drop the P-clamp!**
- ✦ Make sure the nut is accessible from the front.
- ✦ From the other side of the tube, slide the second P-clamp on the metal part of the tube. Mind the correct position of the P-clamp.
- ✦ Insert the nut into the P-clamp and attach it to the M3x12 screw on the left. Slightly tighten the screw using the Allen key from the top with your other hand - a few turns are enough for now. We will completely tighten it later.

STEP 9 Securing the automatic suppression system



- ✦ Align the tube in the P-clamps. There should be an equal piece of tube section protruding out on each side.
- ✦ Fully tighten the P-clamps.

STEP 10 Installing the printer

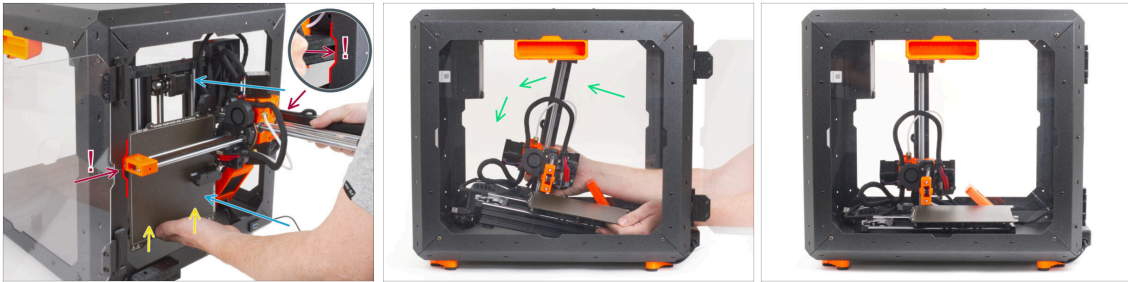

- ◆ Carefully insert the printer inside the enclosure with its base facing forward. **When doing so, be EXTRA CAREFUL to:**
 - ⚠ **Ensure the X-end and aluminum Z-axis profile pass through the right and left cutouts of the front opening. Use EXTRA CAUTION to avoid damaging the printer or enclosure.**
 - ◆ **Hold the heatbed with your left hand to prevent it from sliding down and getting damaged on the bottom plate.**
 - ◆ **During insertion, carefully watch all sides of the printer to ensure nothing is in the way (e.g., cables, motors, etc.).**
- ◆ Carefully place the printer on its feet. We will adjust the exact position later on.
 - ⚠ **Ensure that no parts of the printer touch the side panels to avoid scratches.**

STEP 11 Adjusting printer position

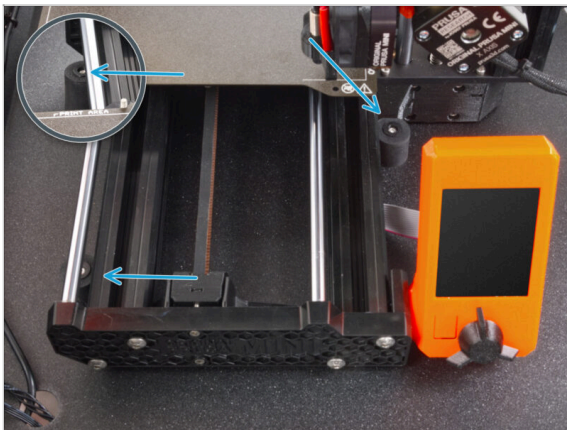

- ◆ Rearrange position of the printer like in the picture. The **printer must be placed between all three anti-slip dampers.**

STEP 12 Connecting the cables

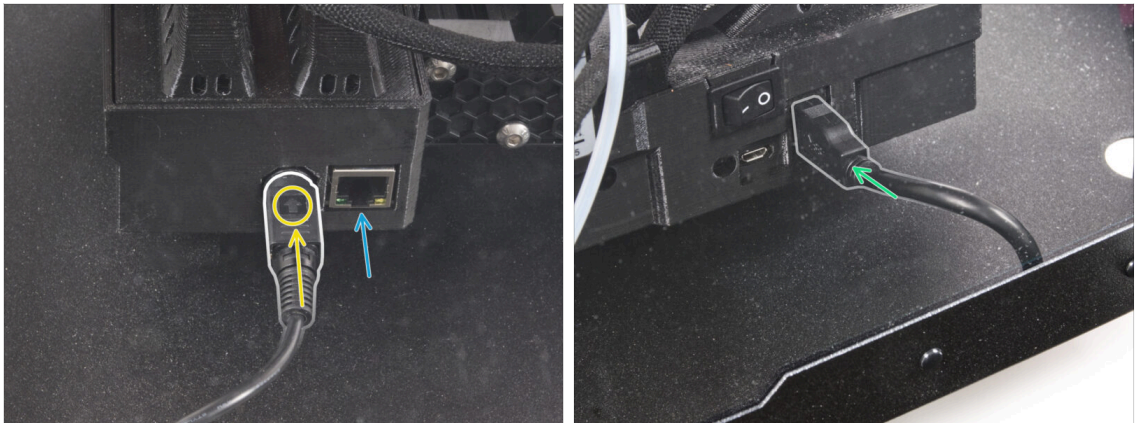

- From the back of the printer, connect the PSU power cable. See the correct orientation of the cable.
 - ⓘ If the space is difficult to access, move the printer closer to the front, **avoiding scratches on the panels**.
- If necessary, connect an ethernet cable, which is optional.
- Connect the USB extension cable from the right side of the printer.

STEP 13 Mounting the side arm



- Insert the side arm into the Spool-holder-r and turn counter-clockwise to lock it.

STEP 14 Connecting the cables

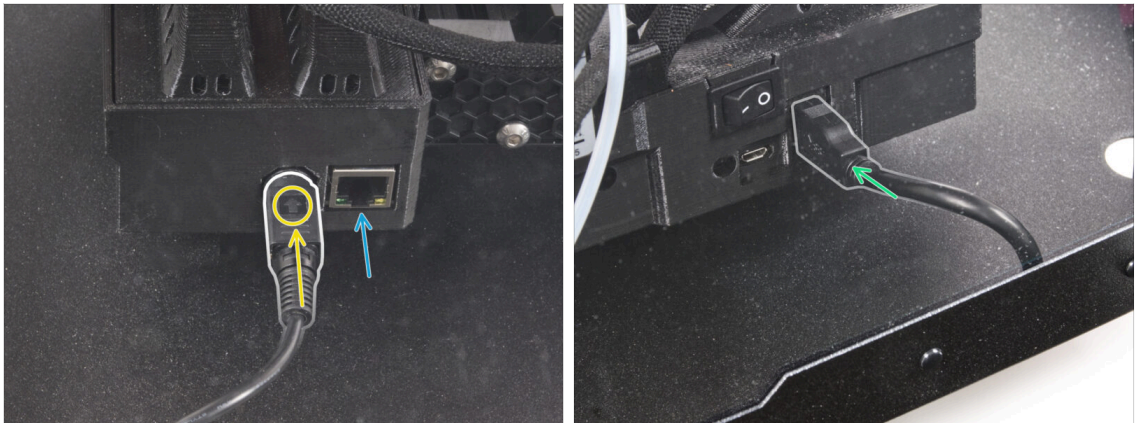

- From the back of the printer, connect the PSU power cable. See the correct orientation of the cable.
 - ⓘ If the space is difficult to access, move the printer closer to the front, **avoiding scratches on the panels**.
- If necessary, connect an ethernet cable, which is optional.
- Connect the USB extension cable from the right side of the printer.

STEP 15 That's it



- That's it! Well done. You have successfully installed the Fire Suppression System in your Original Prusa MINI Enclosure.

Mechanical lock (add-on)

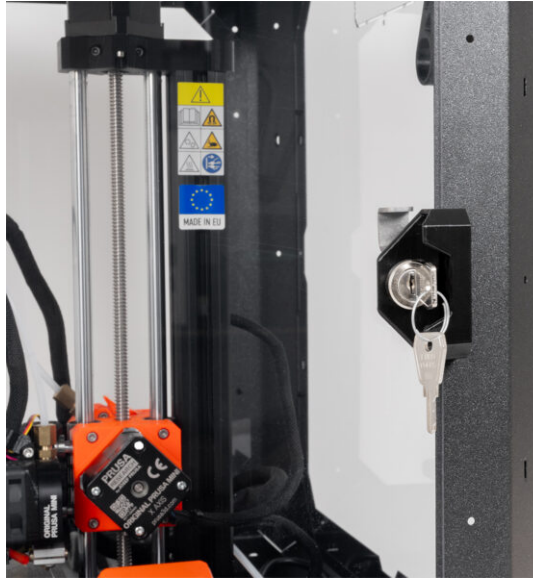

STEP 1 Introduction



- ◆ This guide will take you through the installation of the **Mechanical lock** on the **Original Prusa MINI Enclosure**.
- ⓘ The supplied fasteners contain extra spare parts.

STEP 2 Tools necessary for this chapter

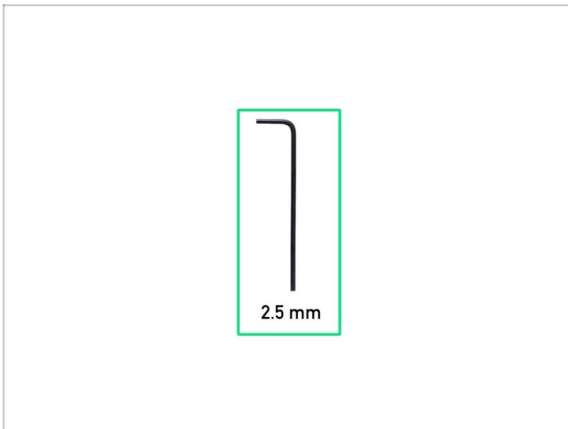

- ◆ **For this chapter, please prepare:**
- ◆ 2.5mm Allen key

STEP 3 Additional tools



i Tools that are not included but can make assembly easier, especially when installing add-ons.

Additional tools:

Needle-nose pliers for securing the E-clip washer

STEP 4 Disassembling the door handle

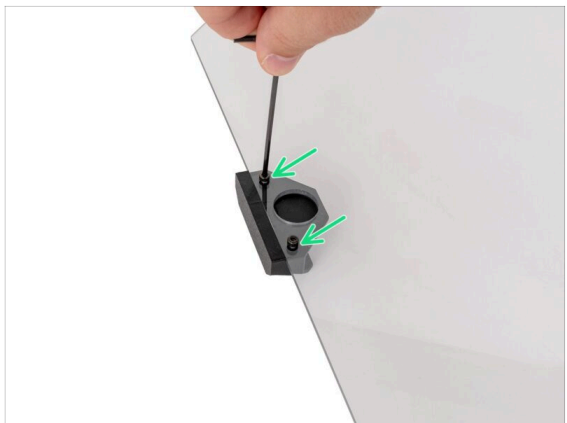
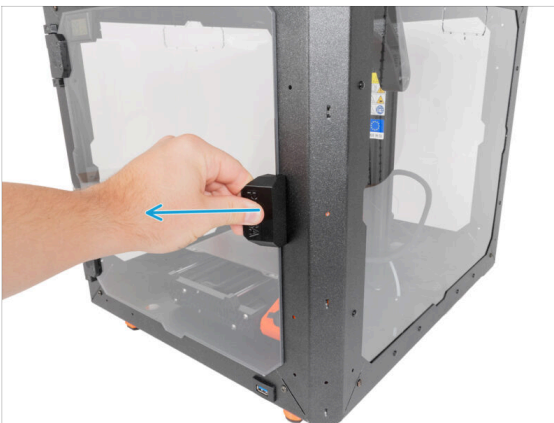

Open the door.

On the door panel, remove two M3x8 screws securing the door-handle and remove it from the panel. **Don't throw the screws away!**

Nice, we are ready to assembly the mechanical lock.

STEP 5 Mechanical lock: parts preparation

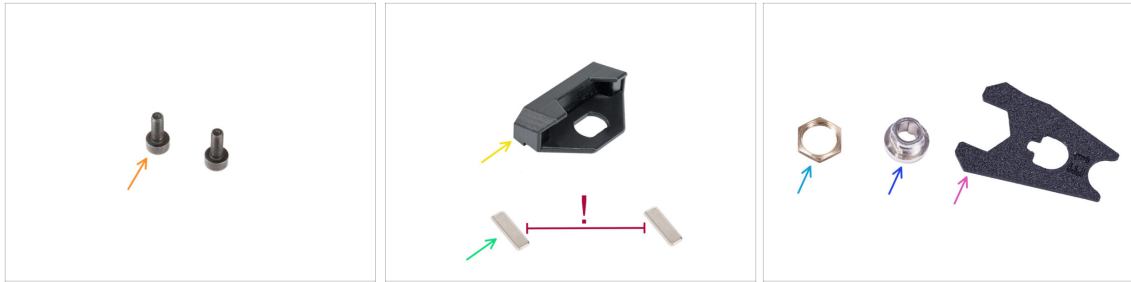

◆ For the following steps, please prepare:

◆ M3x8 screw (2x) removed in the previous step

◆ MINI Enclosure Door Handle (1x)

◆ Magnet 20x6x2 (2x)

⚠ **Keep the magnets apart in a sufficient distance. They can break each other!**

◆ Lock housing nut (1x)

◆ Lock housing (1x)

◆ Lock wrench (1x)

STEP 6 Assembling the lock housing

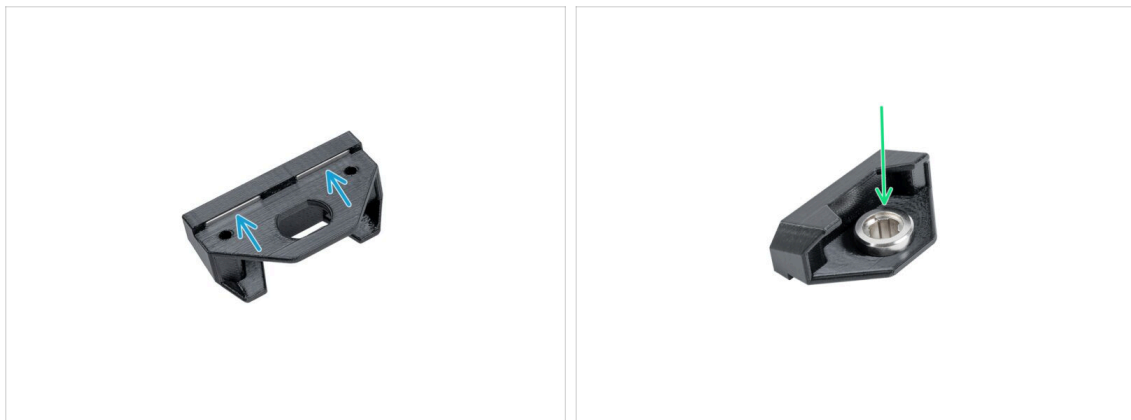

◆ Insert two magnets all the way into two pockets in the door handle.

ⓘ The polarity of the magnets doesn't matter.

◆ Turn the door handle.

◆ Insert the lock housing into the same shape opening in the door handle.

STEP 7 Securing the lock housing



- From the opposite side:
- Insert the nut onto the lock housing.
- Secure the lock housing by tightening the lock housing nut. Use the lock wrench for easier tightening.
- Attach the door handle on the door panel and secure it with two M3x8 screws.

STEP 8 Assembling the lock mechanism: parts preparation

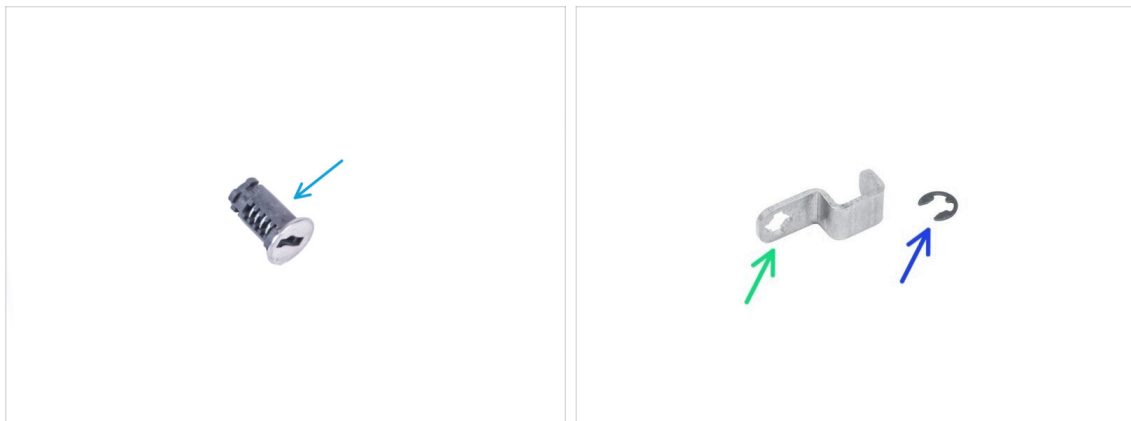

- For the following steps, please prepare:
- Lock (1x)
- Mechanical Lock Lever (1x)
- E-clip washer (1x)

STEP 9 Assembling the lock mechanism



- Insert the Lock into the lock mount.
- Hold the Lock in the Lock mount with your hand and turn the door panel.
- Attach the mechanical Lock Lever to the Lock as shown in the picture. The lock lever must face upwards.

STEP 10 Securing the lock mechanism

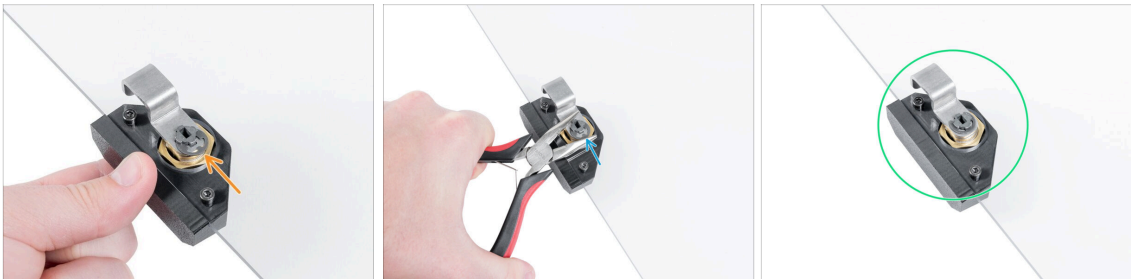

- Place E-clip washer on the Mechanical Lock Lever against the lock.
- Using Needle-nose pliers, push the E-clip washer on the lock to secure the lock mechanism.
- The Mechanical Lock is ready. Compare the picture with your Mechanical Lock.

STEP 11 Good job!



- Perfect! You just successfully assembled the Mechanical lock on your Original Prusa MINI Enclosure. Let's try it out!

Manual changelog MINI Enclosure

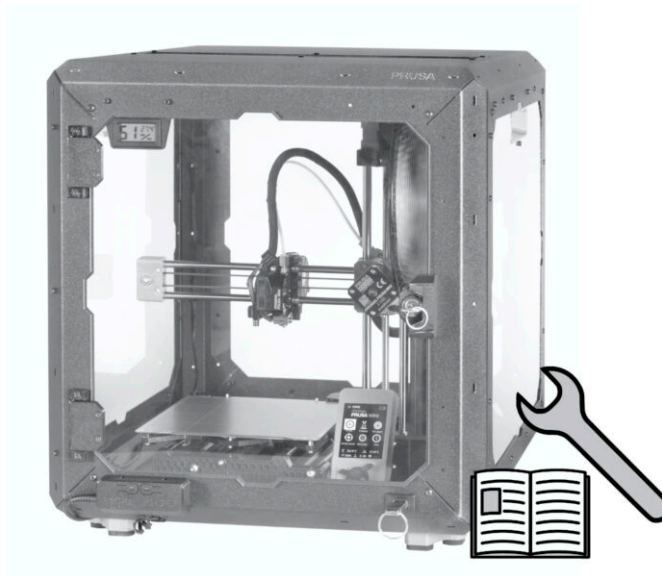

Manual changelog MINI Enclosure







