

# Table of Contents

<b>1. Introduction</b>	15
Step 1 - Enclosure variations info	16
Step 2 - Important information	16
Step 3 - Tools included for the Enclosure assembly	17
Step 4 - Tools required for the printer preparation (not included)	17
Step 5 - Labels guide	18
Step 6 - Use labels for reference	18
Step 7 - View high resolution images	19
Step 8 - Reward yourself	19
Step 9 - How to successfully finish the assembly	20
Step 10 - Optional parts	21
Step 11 - Upgraded to MK4/S & MK3.9/S?	21
Step 12 - Add-ons	22
Step 13 - Spool holder	22
Step 14 - We are here for you!	23
Step 15 - MK3S+ or MK4/S & 3.9/S	24
<b>2A. Preparing the printer (MK4/S &amp; 3.9/S)</b>	25
Step 1 - Tools necessary for this chapter	26
Step 2 - Preparing the printer	26
Step 3 - Disconnecting the xLCD cables	27
Step 4 - Removing the xLCD cable clips	27
Step 5 - Removing the xLCD cables	28
Step 6 - Removing the xLCD cables	28
Step 7 - Removing the xLCD	29
Step 8 - Releasing the PSU	29
Step 9 - Removing the PSU	30
Step 10 - Guiding the cables: parts preparation	30
Step 11 - Guiding the cables	31
Step 12 - Guiding the cables	31
Step 13 - Mounting the printer frame support: part preparation	32
Step 14 - Mounting the printer frame support	32
Step 15 - Mounting the printer frame support	33
Step 16 - Covering the PSU cables: parts preparation	33
Step 17 - Covering the PSU cables	34
Step 18 - Covering the xLCD cables: parts preparation	34
Step 19 - Covering the xLCD cables	35
Step 20 - QSM fitting: parts preparation	35
Step 21 - Installing the QSM fitting	36
Step 22 - MK4S xLCD: parts preparation	36
Step 23 - MK4S xLCD adapters preparation	37
Step 24 - MK4S adapters securing	37
Step 25 - Version A: Disassembling the xLCD	38
Step 26 - Version B: Disassembling the xLCD	38
Step 27 - Version A: Disassembling the xLCD	39
Step 28 - Version B: Disassembling the xLCD	39
Step 29 - Preparing the xLCD: parts preparation	40
Step 30 - Version A: Preparing the xLCD: parts preparation	40
Step 31 - Version B: Preparing the xLCD: parts preparation	41
Step 32 - Preparing the xLCD	41
Step 33 - Version A: Preparing the xLCD	42

Step 34 - Version B: Preparing the xLCD .....	42
Step 35 - Version A: Installing the PE Faston .....	43
Step 36 - Version B: Installing the PE Faston .....	43
Step 37 - Assembling the LCD knob .....	44
Step 38 - Haribo time! .....	44
Step 39 - The printer is prepared .....	45
<b>2B. Preparing the printer (MK3S+ Black PSU) .....</b>	<b>46</b>
Step 1 - Tools necessary for this chapter .....	47
Step 2 - Preparing the printer .....	47
Step 3 - Disconnecting the LCD cables .....	48
Step 4 - Removing the LCD cables .....	48
Step 5 - Removing the LCD cables .....	49
Step 6 - Removing the LCD .....	49
Step 7 - Releasing the PSU .....	50
Step 8 - Removing the PSU .....	50
Step 9 - Guiding the cables: parts preparation .....	51
Step 10 - Guiding the cables .....	51
Step 11 - Guiding the cables .....	52
Step 12 - Mounting the printer frame support: part preparation .....	52
Step 13 - Mounting the printer frame support .....	53
Step 14 - Mounting the printer frame support .....	53
Step 15 - Covering the PSU cables: parts preparation .....	54
Step 16 - Covering the PSU cables .....	54
Step 17 - Covering the LCD cables: parts preparation .....	55
Step 18 - Covering the LCD cables .....	55
Step 19 - Securing the cables .....	56
Step 20 - Removing the FS-cover .....	56
Step 21 - Installing the new FS-cover: parts preparation .....	57
Step 22 - Installing the new FS-cover .....	57
Step 23 - Disassembling the LCD .....	58
Step 24 - Preparing the LCD: parts preparation .....	58
Step 25 - Preparing the LCD .....	59
Step 26 - Preparing the LCD .....	59
Step 27 - Assembling the LCD knob .....	60
Step 28 - Haribo time! .....	60
Step 29 - The printer is prepared .....	61
<b>2C. Preparing the printer (MK3S+ Silver PSU) .....</b>	<b>62</b>
Step 1 - Tools necessary for this chapter .....	63
Step 2 - Preparing the printer .....	63
Step 3 - Disconnecting the LCD cables .....	64
Step 4 - Removing the LCD cables .....	64
Step 5 - Removing the LCD cables .....	65
Step 6 - Removing the LCD .....	65
Step 7 - Releasing the PSU .....	66
Step 8 - Removing the short extrusion .....	66
Step 9 - Repositioning M3nE nuts .....	67
Step 10 - Attaching the short extrusion .....	67
Step 11 - Guiding the cables: parts preparation .....	68
Step 12 - Guiding the cables .....	68
Step 13 - Guiding the cables .....	69
Step 14 - Mounting the printer frame support: part preparation .....	69
Step 15 - Mounting the printer frame support .....	70
Step 16 - Mounting the printer frame support .....	70
Step 17 - Covering the PSU cables: parts preparation .....	71

Step 18 - Covering the PSU cables .....	71
Step 19 - Covering the LCD cables: parts preparation .....	72
Step 20 - Covering the LCD cables .....	72
Step 21 - Securing the cables .....	73
Step 22 - Removing the FS-cover .....	73
Step 23 - Installing the new FS-cover: parts preparation .....	74
Step 24 - Installing the new FS-cover .....	74
Step 25 - Disassembling the LCD .....	75
Step 26 - Preparing the LCD: parts preparation .....	75
Step 27 - Preparing the LCD .....	76
Step 28 - Preparing the LCD .....	76
Step 29 - Assembling the LCD knob .....	77
Step 30 - Haribo time! .....	77
Step 31 - The printer is prepared .....	78
<b>3. Assembling the enclosure .....</b>	<b>79</b>
Step 1 - Tools necessary for this chapter .....	80
Step 2 - LONG vs SHORT profile .....	80
Step 3 - Assembling the base frame: parts preparation .....	81
Step 4 - Assembling the base frame .....	81
Step 5 - Assembling the base frame .....	82
Step 6 - Assembling the feet: parts preparation .....	82
Step 7 - Feet bracket installation .....	83
Step 8 - Assembling the feet .....	83
Step 9 - Attaching the anti-vibration pads .....	84
Step 10 - Assembling the bottom panel: parts preparation .....	84
Step 11 - Assembling the bottom panel .....	85
Step 12 - Securing the bottom panel .....	85
Step 13 - Installing the anti-slip dampers: parts preparation .....	86
Step 14 - Preparing the anti-slip dampers .....	86
Step 15 - Mounting the anti-slip dampers .....	87
Step 16 - Assembling the supports: parts preparation .....	87
Step 17 - Assembling the supports .....	88
Step 18 - Assembling the supports .....	88
Step 19 - Assembling the top frame: parts preparation .....	89
Step 20 - Assembling the top frame .....	89
Step 21 - Assembling the top frame .....	90
Step 22 - Assembling the top panel: parts preparation .....	90
Step 23 - Preparing the top panel .....	91
Step 24 - Assembling the top panel .....	91
Step 25 - Installing the PSU-locks: parts preparation .....	92
Step 26 - Installing the PSU-locks .....	92
Step 27 - Mounting the PSU-locks .....	93
Step 28 - Assembling the hinges: parts preparation .....	93
Step 29 - Assembling the hinges .....	94
Step 30 - Mounting the hinges .....	94
Step 31 - Mounting the hinges .....	95
Step 32 - Assembling the back panel: parts preparation .....	95
Step 33 - Assembling the back panel .....	96
Step 34 - Assembling the back panel .....	96
Step 35 - Assembling the side panel (right): parts preparation .....	97
Step 36 - Assembling the side panel (right): .....	97
Step 37 - Assembling the side panel (left): parts preparation .....	98
Step 38 - Assembling the side panel (left) .....	98
Step 39 - Haribo time! .....	99

Step 40 - Well done!	99
Step 41 - PSU variant for MK3S+	100
Step 42 - Enclosure + MK4/MK3.9	100
<b>4A. Installing the printer (MK4/S &amp; 3.9/S)</b>	<b>101</b>
Step 1 - Tools necessary for this chapter	102
Step 2 - Assembling the PSU holder: parts preparation	102
Step 3 - Assembling the PSU holder: parts preparation	103
Step 4 - Assembling the PSU holder	103
Step 5 - Assembling the PSU holder	104
Step 6 - Assembling the PSU holder	104
Step 7 - Assembling the PSU holder	105
Step 8 - Assembling the PSU holder	105
Step 9 - Covering the PSU: parts preparation	106
Step 10 - Covering the PSU	106
Step 11 - Guiding the PSU cable bundle	107
Step 12 - Installing the printer	107
Step 13 - Installing the printer	108
Step 14 - Installing the PSU	108
Step 15 - Installing the PSU	109
Step 16 - Adjusting the printer	109
Step 17 - Mounting the xLCD: parts preparation	110
Step 18 - Version A: Mounting the xLCD	110
Step 19 - Version B: Mounting the xLCD	111
Step 20 - Version B: Mounting the xLCD	111
Step 21 - Securing the xLCD cable	112
Step 22 - Assembling the filament guide: parts preparation	112
Step 23 - Assembling the filament guide	113
Step 24 - Mounting the filament guide	113
Step 25 - Guiding the PTFE tube	114
Step 26 - Assembling the thermometer: parts preparation	114
Step 27 - Assembling the thermometer	115
Step 28 - Assembling doors: parts preparation	115
Step 29 - Assembling doors: parts preparation	116
Step 30 - Assembling the door magnets	116
Step 31 - Assembling doors	117
Step 32 - Installing the door magnets	117
Step 33 - Mounting the door handles	118
Step 34 - Installing the door	119
Step 35 - Installing the top plugs	119
Step 36 - Installing the top plugs	120
Step 37 - Removing the side arm	120
Step 38 - Installing spool holder: parts preparation	121
Step 39 - Installing spool holder	121
Step 40 - MK4S Spool installation	122
Step 41 - Transport handle (optional): parts preparation	122
Step 42 - Installing the transport handle (optional)	123
Step 43 - Installing the transport handle (optional)	123
Step 44 - Reward yourself!	124
Step 45 - That's it!	124
Step 46 - Enclosure add-ons	125
<b>4B. Installing the printer (MK3S+ Black PSU)</b>	<b>126</b>
Step 1 - Tools necessary for this chapter	127
Step 2 - Assembling the PSU holder: parts preparation	127
Step 3 - Assembling the PSU holder: parts preparation	128

Step 4 - Assembling the PSU holder .....	128
Step 5 - Assembling the PSU holder .....	129
Step 6 - Assembling the PSU holder .....	129
Step 7 - Assembling the PSU holder .....	130
Step 8 - Assembling the PSU holder .....	130
Step 9 - Covering the PSU: parts preparation .....	131
Step 10 - Covering the PSU .....	131
Step 11 - Guiding the PSU cable bundle .....	132
Step 12 - Installing the printer .....	132
Step 13 - Installing the printer .....	133
Step 14 - Installing the PSU .....	133
Step 15 - Installing the PSU .....	134
Step 16 - Adjusting the printer .....	134
Step 17 - Mounting the LCD: parts preparation .....	135
Step 18 - Mounting the LCD .....	135
Step 19 - Securing the LCD cable .....	136
Step 20 - Assembling the filament guide: parts preparation .....	136
Step 21 - Assembling the filament guide .....	137
Step 22 - Mounting the filament guide .....	137
Step 23 - Guiding the PTFE tube .....	138
Step 24 - Assembling the thermometer: parts preparation .....	138
Step 25 - Assembling the thermometer .....	139
Step 26 - Assembling doors: parts preparation .....	139
Step 27 - Assembling doors: parts preparation .....	140
Step 28 - Assembling the door magnets .....	140
Step 29 - Assembling doors .....	141
Step 30 - Installing the door magnets .....	141
Step 31 - Mounting the door handles .....	142
Step 32 - Installing the door .....	143
Step 33 - Installing the top plugs .....	143
Step 34 - Installing the top plugs .....	144
Step 35 - Removing the side arm .....	144
Step 36 - Installing spool holder: parts preparation .....	145
Step 37 - Installing spool holder .....	145
Step 38 - Transport handle (optional): parts preparation .....	146
Step 39 - Installing the transport handle (optional) .....	146
Step 40 - Installing the transport handle (optional) .....	147
Step 41 - Reward yourself! .....	147
Step 42 - That's it! .....	148
Step 43 - Enclosure add-ons .....	148
<b>4C. Installing the printer (MK3S+ Silver PSU) .....</b>	<b>149</b>
Step 1 - Tools necessary for this chapter .....	150
Step 2 - Assembling the PSU holder: parts preparation .....	150
Step 3 - Assembling the PSU holder: parts preparation .....	151
Step 4 - Assembling the PSU holder .....	151
Step 5 - Assembling the PSU holder .....	152
Step 6 - Assembling the PSU holder .....	152
Step 7 - Assembling the PSU holder .....	153
Step 8 - Assembling the PSU holder .....	153
Step 9 - Attaching the SILVER-PSU-retainer .....	154
Step 10 - Guiding the PSU cable bundle .....	154
Step 11 - Installing the printer .....	155
Step 12 - Installing the printer .....	155
Step 13 - Installing the PSU .....	156

Step 14 - Installing the PSU .....	156
Step 15 - Adjusting the printer .....	157
Step 16 - Mounting the LCD: parts preparation .....	157
Step 17 - Mounting the LCD .....	158
Step 18 - Securing the LCD cable .....	158
Step 19 - Assembling the filament guide: parts preparation .....	159
Step 20 - Assembling the filament guide .....	159
Step 21 - Mounting the filament guide .....	160
Step 22 - Guiding the PTFE tube .....	160
Step 23 - Assembling the thermometer: parts preparation .....	161
Step 24 - Assembling the thermometer .....	161
Step 25 - Assembling doors: parts preparation .....	162
Step 26 - Assembling doors: parts preparation .....	162
Step 27 - Assembling the door magnets .....	163
Step 28 - Assembling doors .....	163
Step 29 - Installing the door magnets .....	164
Step 30 - Mounting the door handles .....	164
Step 31 - Installing the door .....	165
Step 32 - Installing the top plugs .....	165
Step 33 - Installing the top plugs .....	166
Step 34 - Removing the side arm .....	166
Step 35 - Installing spool holder: parts preparation .....	167
Step 36 - Installing spool holder .....	167
Step 37 - Transport handle (optional): parts preparation .....	168
Step 38 - Installing the transport handle (optional) .....	168
Step 39 - Installing the transport handle (optional) .....	169
Step 40 - Reward yourself! .....	169
Step 41 - That's it! .....	170
Step 42 - Enclosure add-ons .....	170
<b>Manual changelog Enclosure kit .....</b>	<b>171</b>
Step 1 - Versions history .....	172
Step 2 - Changes to the manual (1) .....	172
Step 3 - Changes to the manual (2) .....	173
Step 4 - Changes to the manual (3) .....	173
Step 5 - Changes to the manual (4) .....	174
<b>5. Fire Suppression System (add-on) .....</b>	<b>175</b>
Step 1 - Introduction .....	176
Step 2 - Tools necessary for this guide .....	176
Step 3 - Preparing the printer .....	177
Step 4 - Parts preparation: .....	177
Step 5 - Mounting the P-clamp .....	178
Step 6 - Mounting the P-clamp .....	178
Step 7 - Installing the automatic suppression system .....	179
Step 8 - Securing the automatic suppression system .....	179
Step 9 - That's it! .....	180
<b>6. Hinged Lid (add-on) .....</b>	<b>181</b>
Step 1 - Introduction .....	182
Step 2 - Tools necessary for this chapter .....	182
Step 3 - Removing the covers .....	183
Step 4 - Removing the top panel .....	183
Step 5 - Installing the lid hinges: parts preparation .....	184
Step 6 - Assembling the lid hinges .....	184
Step 7 - Assembling the lid hinges .....	185
Step 8 - Installing the lid hinges .....	185

Step 9 - Installing the lid hinges .....	186
Step 10 - Installing the lid hinges .....	186
Step 11 - Installing the top panel .....	187
Step 12 - Installing the covers: parts preparation .....	187
Step 13 - Installing the covers .....	188
Step 14 - Mounting the handle: parts preparation .....	188
Step 15 - Mounting the handle .....	189
Step 16 - Mounting the locks: parts preparation .....	189
Step 17 - Mounting the locks .....	190
Step 18 - Locking the locks .....	190
Step 19 - MMU Installation .....	191
<b>6A. Hinged Lid with MMU3 .....</b>	<b>192</b>
Step 1 - Introduction .....	193
Step 2 - Printable parts .....	193
Step 3 - LCD Removal .....	194
Step 4 - Spool Holder Removal .....	194
Step 5 - Filament Guide Removal .....	195
Step 6 - PSU Removal .....	195
Step 7 - Printer Removal .....	196
Step 8 - MMU3 Installation .....	196
Step 9 - Buffer Removal .....	197
Step 10 - Spool Holders: Parts preparation .....	197
Step 11 - Spool Holders Preparation 1 .....	198
Step 12 - Spool Holders Preparation 2 .....	198
Step 13 - Spool Holders Installation 1 .....	199
Step 14 - Spool Holders Installation 2 .....	199
Step 15 - Internal Lock parts preparation .....	200
Step 16 - Internal Lock Preparation .....	200
Step 17 - Internal Lock Installation .....	201
Step 18 - PTFE Side Holder parts preparation .....	201
Step 19 - PTFE Side Holder Preparation .....	202
Step 20 - PTFE Side Holder Installation 1 .....	202
Step 21 - PTFE Side Holder Installation 2 .....	203
Step 22 - Covers Removal .....	203
Step 23 - Buffer Mount: parts preparation .....	204
Step 24 - Buffer Mount Installation .....	204
Step 25 - PTFE Passthrough Installation .....	205
Step 26 - Buffer Preparation 1 .....	205
Step 27 - Buffer Preparation 2 .....	206
Step 28 - Enclosure Buffer: parts preparation .....	206
Step 29 - Magnets Installation .....	207
Step 30 - Enclosure Buffer Assembly 1 .....	207
Step 31 - Enclosure Buffer Assembly 2 .....	208
Step 32 - Enclosure Buffer Assembly 3 .....	208
Step 33 - Enclosure Buffer Installation .....	209
Step 34 - Printer Preparation .....	209
Step 35 - Printer Installation .....	210
Step 36 - PSU Installation .....	210
Step 37 - Printer Positioning .....	211
Step 38 - LCD Installation: parts preparation .....	211
Step 39 - LCD Connection .....	212
Step 40 - LCD Installation .....	212
Step 41 - PTFE Tubes: part preparation .....	213
Step 42 - PTFE Tube Installation 1 .....	213

Step 43 - PTFE Tube Installation 2 .....	214
Step 44 - PTFE Tube Installation 3 .....	214
Step 45 - PTFE Tube Installation 4 .....	215
Step 46 - Loading the Filaments .....	215
Step 47 - Done .....	216
<b>6B. Hinged lid with MMU2S .....</b>	<b>217</b>
Step 1 - Introduction .....	218
Step 2 - Removing the LCD .....	218
Step 3 - Removing the filament guide .....	219
Step 4 - Removing the printer .....	219
Step 5 - Removing the printer .....	220
Step 6 - Installing the MMU2S .....	220
Step 7 - Preparing the printer (MK3S+ with MMU2S) .....	221
Step 8 - Installing the printer .....	221
Step 9 - Installing the PSU .....	222
Step 10 - Adjusting the printer .....	222
Step 11 - Mounting the LCD: parts preparation .....	223
Step 12 - Mounting the LCD .....	223
Step 13 - Assembling the grommets: parts preparation .....	224
Step 14 - Assembling the MMU-grommets .....	224
Step 15 - Mounting the MMU-grommets .....	225
Step 16 - Mounting the MMU-grommets .....	225
Step 17 - Mounting the MMU-grommets (optional) .....	226
Step 18 - Guiding the PTFE tubes .....	226
Step 19 - Assembling the buffer feet: parts preparation .....	227
Step 20 - Assembling the buffer feet .....	227
Step 21 - Mounting the buffer feet .....	228
Step 22 - Mounting the buffer feet .....	228
Step 23 - Joining the buffer .....	229
Step 24 - That's it! .....	229
<b>7. Advanced filtration system (add-on) .....</b>	<b>230</b>
Step 1 - Introduction .....	231
Step 2 - Different external PSU .....	231
Step 3 - Introduction - External PSU Delta .....	232
Step 4 - Tools necessary for this chapter .....	232
Step 5 - Mounting the external PSU (optional): parts preparation .....	233
Step 6 - Mounting the external PSU (optional) .....	233
Step 7 - Assembling the external PSU bracket (optional) .....	234
Step 8 - Preparing the printer .....	234
Step 9 - Removing the PSU .....	235
Step 10 - Guiding the external PSU cable .....	235
Step 11 - Guiding the external PSU cable .....	236
Step 12 - Guiding the external PSU cable (optional) .....	236
Step 13 - Mounting the external PSU (optional) .....	237
Step 14 - Installing the PSU .....	237
Step 15 - Guiding the external PSU cable .....	238
Step 16 - Guiding the external PSU cable .....	238
Step 17 - Assembling the filtration: parts preparation .....	239
Step 18 - Assembling the filtration: parts preparation .....	239
Step 19 - Assembling the filtration .....	240
Step 20 - Assembling the filtration .....	240
Step 21 - Assembling the filtration .....	241
Step 22 - Installing the blower .....	241
Step 23 - Inserting the HEPA filter .....	242



Step 24 - Inserting the HEPA filter .....	242
Step 25 - Installing the filtration .....	243
Step 26 - Installing the filtration .....	243
Step 27 - Installing the filtration .....	244
Step 28 - Guiding the filtration cable: parts preparation .....	244
Step 29 - Guiding the filtration cable .....	245
Step 30 - Guiding the filtration cable .....	245
Step 31 - Guiding the filtration cable .....	246
Step 32 - Guiding the filtration cable .....	246
Step 33 - Installing the basic board: parts preparation .....	247
Step 34 - Installing the basic board .....	247
Step 35 - Installing the basic board .....	248
Step 36 - Connecting the filtration cable .....	248
Step 37 - Mounting the basic board .....	248
Step 38 - Connecting the external PSU .....	249
Step 39 - Connecting the Power cord: parts preparation .....	249
Step 40 - Connecting the Power cord .....	250
Step 41 - Well done! .....	250
Step 42 - Introduction - External PSU XP Power .....	251
Step 43 - Tools necessary for this chapter .....	251
Step 44 - Suggestion .....	252
Step 45 - Mounting the external PSU (optional): parts preparation .....	252
Step 46 - Mounting the external PSU (optional) .....	253
Step 47 - Assembling the external PSU bracket (optional) .....	253
Step 48 - Removing the LCD .....	254
Step 49 - Removing the printer .....	254
Step 50 - Removing the printer .....	255
Step 51 - Removing the printer .....	255
Step 52 - Loosening the bottom panel .....	256
Step 53 - Mounting the external PSU .....	256
Step 54 - Guiding the external PSU cable .....	257
Step 55 - Guiding the external PSU cable .....	257
Step 56 - Tightening the bottom panel .....	258
Step 57 - Loosening the bottom panel .....	258
Step 58 - Guiding the external PSU cable .....	259
Step 59 - Guiding the external PSU cable .....	259
Step 60 - Guiding the external PSU cable .....	260
Step 61 - Tightening the bottom panel .....	260
Step 62 - Assembling the filtration: parts preparation .....	261
Step 63 - Assembling the filtration: parts preparation .....	261
Step 64 - Assembling the filtration .....	262
Step 65 - Assembling the filtration .....	262
Step 66 - Assembling the filtration .....	263
Step 67 - Installing the blower .....	263
Step 68 - Inserting the HEPA filter .....	264
Step 69 - Inserting the HEPA filter .....	264
Step 70 - Installing the filtration .....	265
Step 71 - Installing the filtration .....	265
Step 72 - Guiding the filtration cable: parts preparation .....	266
Step 73 - Guiding the filtration cable .....	266
Step 74 - Guiding the filtration cable .....	267
Step 75 - Installing the PSU .....	267
Step 76 - Guiding the cables .....	268
Step 77 - Guiding the filtration cable .....	268
Step 78 - Mounting the LCD: parts preparation .....	269

Step 79 - Mounting the LCD .....	269
Step 80 - Securing the LCD cable .....	270
Step 81 - Installing the basic board: parts preparation .....	270
Step 82 - Installing the basic board .....	271
Step 83 - Installing the basic board .....	271
Step 84 - Connecting the filtration cable .....	271
Step 85 - Mounting the basic board .....	272
Step 86 - Connecting the external PSU .....	272
Step 87 - Connecting the PTFE tube .....	273
Step 88 - Connecting the Power cord: parts preparation .....	273
Step 89 - Connecting the Power cord .....	274
Step 90 - Well done! .....	274
<b>8. Mechanical lock (add-on) .....</b>	<b>275</b>
Step 1 - Introduction .....	276
Step 2 - Tools necessary for this chapter .....	276
Step 3 - Removing the door panel .....	277
Step 4 - Disassembling the door panel .....	277
Step 5 - Assembling the lock insert: parts preparation .....	278
Step 6 - Assembling the lock housing .....	278
Step 7 - Assembling the door holders: parts preparation .....	279
Step 8 - Assembling the door holders .....	279
Step 9 - Mounting the Lock Door Holders .....	280
Step 10 - Assembling the lock mechanism: parts preparation .....	280
Step 11 - Assembling the lock mechanism .....	281
Step 12 - Assembling the lock mechanism .....	281
Step 13 - Mounting the rods: parts preparation .....	282
Step 14 - Mounting the rods .....	282
Step 15 - Mounting the rods .....	283
Step 16 - Mounting the rods .....	283
Step 17 - Mounting the rods .....	284
Step 18 - Covering the lock mechanism: parts preparation .....	284
Step 19 - Covering the lock mechanism .....	285
Step 20 - Installing the rod latches: parts preparation .....	285
Step 21 - Installing the rod latches .....	286
Step 22 - Attaching the door panel .....	286
Step 23 - That's it! .....	287
<b>9. Quick release PSU cable - MK3S+ Black PSU (add-on) .....</b>	<b>288</b>
Step 1 - Introduction .....	289
Step 2 - Tools necessary for this chapter .....	289
Step 3 - Removing the LCD .....	290
Step 4 - Removing the printer .....	290
Step 5 - Removing the printer .....	291
Step 6 - Removing the printer .....	291
Step 7 - Disconnecting the PSU .....	292
Step 8 - Disconnecting the PSU cables .....	292
Step 9 - Disconnecting the PSU cables .....	293
Step 10 - Installing the quick release cable: parts preparation .....	293
Step 11 - Installing the quick release cable .....	293
Step 12 - Connecting the PSU cables .....	294
Step 13 - Covering the PSU: parts preparation .....	294
Step 14 - Covering the PSU .....	295
Step 15 - Connecting the power cables .....	295
Step 16 - Organizing the cables .....	296
Step 17 - Covering the quick release cable: parts preparation .....	296

Step 18 - Covering the quick release cable .....	297
Step 19 - Covering the quick release cable .....	297
Step 20 - Installing the PSU .....	298
Step 21 - Installing the printer .....	298
Step 22 - Connecting the quick release cable .....	299
Step 23 - Mounting the LCD: parts preparation .....	299
Step 24 - Mounting the LCD .....	300
Step 25 - Connecting the PTFE tube .....	300
Step 26 - Well done! .....	301
<b>10. Quick release PSU cable - MK4/3.9 Black PSU (add-on) .....</b>	<b>302</b>
Step 1 - Introduction .....	303
Step 2 - Tools necessary for this chapter .....	303
Step 3 - Removing the xLCD .....	304
Step 4 - Removing the xLCD cables .....	304
Step 5 - Removing the PTFE tube .....	305
Step 6 - Removing the printer .....	305
Step 7 - Removing the printer .....	306
Step 8 - Disconnecting the PSU .....	306
Step 9 - xLCD cable bundle sleeve .....	307
Step 10 - xBuddy box cover .....	307
Step 11 - Disconnecting the PSU cables .....	308
Step 12 - Installing the quick release cable: parts preparation .....	308
Step 13 - Quick release cable: power panic .....	309
Step 14 - Installing the quick release cable .....	309
Step 15 - Connecting the PSU cables .....	310
Step 16 - Covering the PSU: parts preparation .....	310
Step 17 - Covering the PSU .....	311
Step 18 - Connecting the PSU cables: parts preparation .....	311
Step 19 - Connecting the PSU cables .....	312
Step 20 - Covering the xBuddy box: parts preparation .....	312
Step 21 - Covering the xBuddy box: bottom cover .....	313
Step 22 - Covering the xBuddy box: bottom cover tightening .....	313
Step 23 - xBuddy box cover .....	314
Step 24 - Covering the quick release cable: parts preparation .....	314
Step 25 - Covering the quick release cable .....	315
Step 26 - Covering the xLCD cables: parts preparation .....	315
Step 27 - Covering the xLCD cable bundle .....	316
Step 28 - Installing the PSU .....	316
Step 29 - Installing the printer .....	317
Step 30 - Connecting the quick release cable .....	317
Step 31 - Mounting the xLCD: parts preparation .....	318
Step 32 - Version A: Mounting the xLCD .....	318
Step 33 - Version B: Mounting the xLCD .....	319
Step 34 - Mounting the xLCD .....	319
Step 35 - Securing the xLCD cable .....	320
Step 36 - Connecting the PTFE tube .....	320
Step 37 - Well done! .....	321
<b>11. White LED strip (add-on) .....</b>	<b>322</b>
Step 1 - Introduction .....	323
Step 2 - Different external PSU .....	323
Step 3 - Introduction - External PSU Delta .....	324
Step 4 - Tools necessary for this chapter .....	324
Step 5 - Mounting the external PSU (optional): parts preparation .....	325
Step 6 - Mounting the external PSU (optional) .....	325

Step 7 - Assembling the external PSU bracket (optional) .....	326
Step 8 - Preparing the printer .....	326
Step 9 - Guiding the external PSU cable .....	327
Step 10 - Guiding the external PSU cable .....	327
Step 11 - Guiding the external PSU cable .....	328
Step 12 - Mounting the external PSU (optional) .....	328
Step 13 - Installing the PSU .....	329
Step 14 - Guiding the external PSU cable .....	329
Step 15 - Guiding the external PSU cable .....	330
Step 16 - Assembling the LED strip: parts preparation .....	330
Step 17 - Assembling the LED strip .....	331
Step 18 - Assembling the LED strip .....	331
Step 19 - Mounting the LED strip .....	332
Step 20 - Connecting the LED strip: parts preparation .....	332
Step 21 - Guiding the cables .....	333
Step 22 - Connecting the LED cable .....	333
Step 23 - Installing the basic board: parts preparation .....	334
Step 24 - Installing the basic board .....	334
Step 25 - Installing the basic board .....	335
Step 26 - Connecting the LED cable .....	335
Step 27 - Mounting the basic board .....	335
Step 28 - Connecting the external PSU .....	336
Step 29 - Connecting the Power cord: parts preparation .....	336
Step 30 - Connecting the Power cord .....	337
Step 31 - That's all! .....	337
Step 32 - Introduction - External PSU XP Power .....	338
Step 33 - Tools necessary for this chapter .....	338
Step 34 - Suggestion .....	339
Step 35 - Mounting the external PSU (optional): parts preparation .....	339
Step 36 - Mounting the external PSU (optional) .....	340
Step 37 - Assembling the external PSU bracket (optional) .....	340
Step 38 - Removing the LCD .....	341
Step 39 - Removing the printer .....	341
Step 40 - Preparing the printer .....	342
Step 41 - Preparing the printer .....	342
Step 42 - Removing the printer .....	343
Step 43 - Loosening the bottom panel .....	343
Step 44 - Mounting the external PSU .....	344
Step 45 - Guiding the external PSU cable .....	344
Step 46 - Guiding the external PSU cable .....	345
Step 47 - Tightening the bottom panel .....	345
Step 48 - Loosening the bottom panel .....	346
Step 49 - Guiding the external PSU cable .....	346
Step 50 - Guiding the external PSU cable .....	347
Step 51 - Guiding the external PSU cable .....	347
Step 52 - Tightening the bottom panel .....	348
Step 53 - Inserting the printer .....	349
Step 54 - Installing the PSU .....	349
Step 55 - Guiding the external PSU cable: parts preparation .....	350
Step 56 - Guiding the external PSU cable .....	350
Step 57 - Assembling the LED strip: parts preparation .....	351
Step 58 - Assembling the LED strip .....	351
Step 59 - Assembling the LED strip .....	352
Step 60 - Mounting the LED strip .....	352
Step 61 - Connecting the LED strip: parts preparation .....	353

Step 62 - Connecting the LED cable .....	353
Step 63 - Mounting the LCD: parts preparation .....	354
Step 64 - Mounting the LCD .....	354
Step 65 - Securing the LCD cable .....	355
Step 66 - Installing the basic board: parts preparation .....	355
Step 67 - Installing the basic board .....	356
Step 68 - Installing the basic board .....	356
Step 69 - Connecting the LED cable .....	356
Step 70 - Mounting the basic board .....	357
Step 71 - Connecting the external PSU .....	357
Step 72 - Connecting the PTFE tube .....	358
Step 73 - Connecting the Power cord: parts preparation .....	358
Step 74 - Connecting the Power cord .....	359
Step 75 - That's all! .....	359



# 1. Introduction



## STEP 1 Enclosure variations info

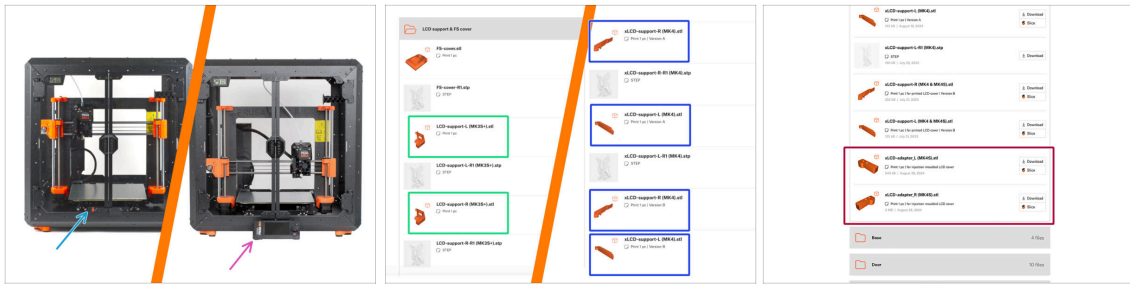

- ◆ **This manual is for the Enclosure with the external printer display mount.** Printed parts for external display mounting are no longer included from the end of May 2024). If you purchased before, you can continue with this manual.
- ◆ If you prefer to keep the display inside (on the printer), refer to the [Original Prusa Enclosure \(display inside\)](#) assembly manual.
- ◆ Do you want to install the display externally and have a new package without the required parts? You can download and print them.
- ◆ **Required Parts for external display mount:**
  - ◆ **MK3S+:** ENCLOSURE LCD SUPPORT LEFT, RIGHT
  - ◆ **MK4, MK3.9, MK3.5:** ENCLOSURE XLCD SUPPORT LEFT, RIGHT - *for the MK4, you need to check A or B version according the [MK4 assembly manual](#).*
  - ◆ **MK4S:** xLCD-adapter\_R (MK4S), xLCD-adapter\_L (MK4S)
  - ◆ Parts files available on [Printables.com](#).
- ◆ **To confirm your package:** check the ENCLOSURE 1/2 Plastic Parts package label to see if it includes the ENCLOSURE LCD SUPPORT or ENCLOSURE XLCD SUPPORT parts.

## STEP 2 Important information

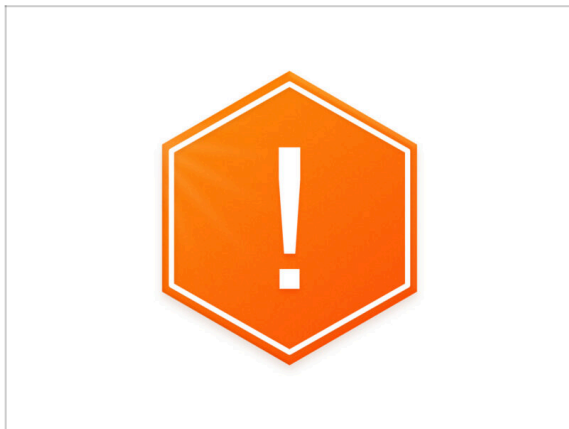

- ⚠ **Important notice:** the package contains metal sheet profiles that have sharp edges. Handle the parts very carefully.
- ⚠ **If children are involved in assembly, always supervise them to avoid injury.**



### STEP 3 Tools included for the Enclosure assembly

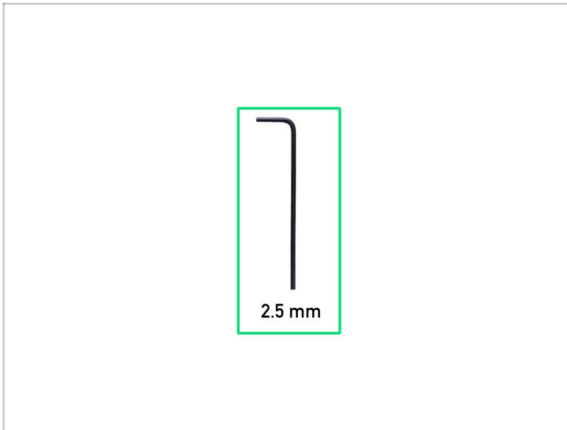

- **The kit includes:**
- 2.5mm Allen key

### STEP 4 Tools required for the printer preparation (not included)

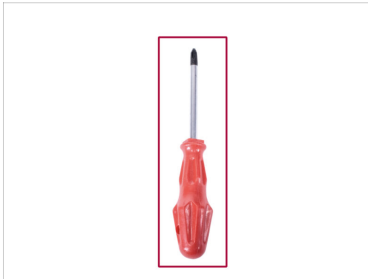

- **The following tools are needed in the next chapter to prepare the printer, some of them were included with the printer:**
- Needle-nose or cutting pliers (*to trim the zip ties*)
- Phillips screwdriver PH2
- Cardboard box *at least 15 x 15 x 8 cm (e.g. Prusament box)*
- Snip-off knife or a pocket knife
- Piece of cloth (*to protect the heatbed, min. 15 x 15 cm*)
- 3.0mm Allen key (*MK3S+ Silver PSU only*)

## STEP 5 Labels guide



- All the boxes and bags including parts for the build are labelled.
- The FASTENERS A and FASTENERS B bags include an extra spare of each part contained in the bag. The amount of spare parts is always written on the label under the individual part. This number is included in the total number of each type of part.
- ⓘ The amount of the nylon rivet spare might slightly differ, but never less than the amount indicated on the label.

## STEP 6 Use labels for reference

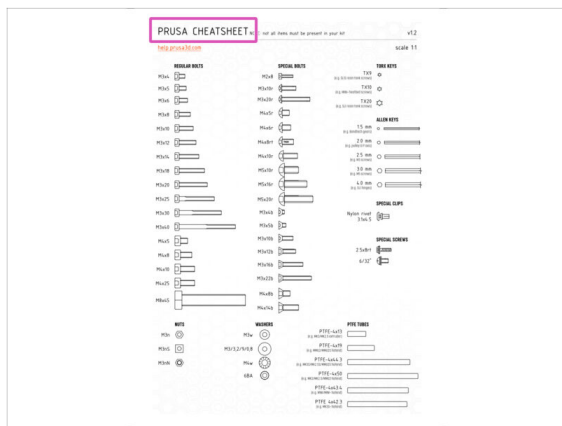

- Fasteners on the labels has a scale of 1:1 and can be used to identify parts :-)
- ⓘ The numbers in parentheses below the fastener picture indicate the number of extra pieces added to the SPARE package.
- For the most common screws and nuts you can also use the enclosed letter, which contains Prusa Cheatsheet on the other side.
- ⓘ You can download it from our site [help.prusa3d.com/cheatsheet](http://help.prusa3d.com/cheatsheet). Print it at 100 %, don't rescale it, otherwise, it won't work.

## STEP 7 View high resolution images

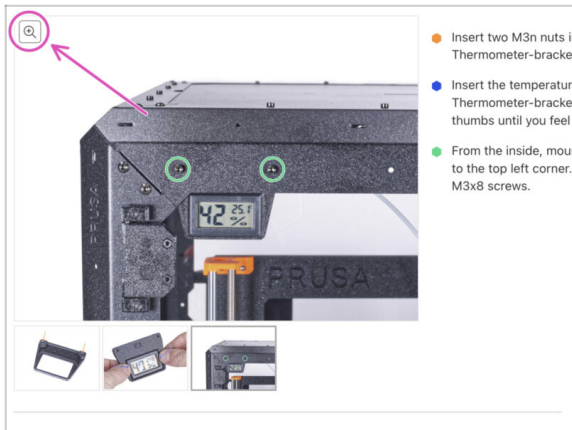

**i** When you browse the guide on [help.prusa3d.com](https://help.prusa3d.com), you can view the original images in high resolution for clarity.

Just hover your cursor over the image and click the Magnifier button ("View original") in the top left corner.

## STEP 8 Reward yourself



From the experience of building Original Prusa printers, we know that Haribo Bears are an integral and important part of every kit. Although it's not entirely about building a printer now, we've got your safety in mind, and added some amount of gummy bears to your kit as well.

**!** **Do not eat the whole bag right at the beginning of the assembly! It is VERY IMPORTANT to distribute the amount correctly during assembly. We tried all sorts of combinations of quantities. Finally, we reached a successful result.**

Open the package and arrange the gummy bears according to the picture. **Don't eat anything now!** Always wait for instructions.

**i** **Your package might contain fewer bears.** In such a case, run immediately to the nearest candy store! **The exact dosage is absolutely critical!!!**

Eat the first gummy bear to boost your energy. Really, just one!

## STEP 9 How to successfully finish the assembly

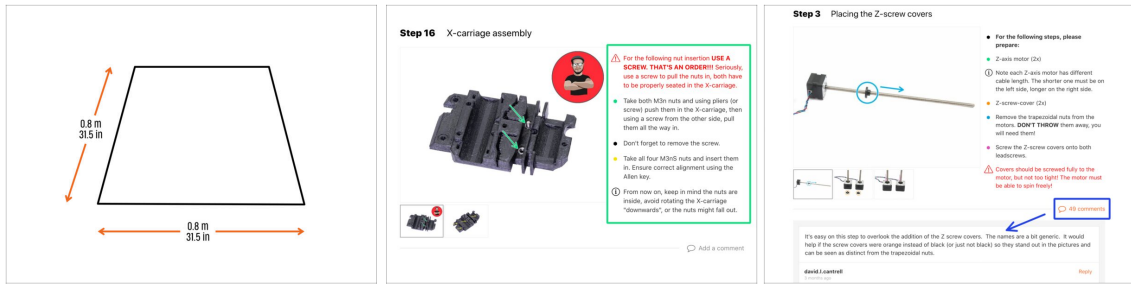

For a better handling, it is recommended to **prepare a clean workbench with a space of at least 0.8 m x 0.8 m (31.5 in x 31.5 in)**. With access from two sides or more.



We're recommending a **bright light above your workbench**. Some parts inside the enclosure are dark and inadequate light could make a very difficult procedure.



**Always read all the instructions at the current step first.** This will help you to understand, what you need to do. **Don't cut or trim unless you are told to!!!**



**Don't follow pictures only!** It is not enough, the written instructions are as brief as they can be. Read them.



**Read the comments** from the other users. They are a great source of ideas. We read them too and based on your feedback improve the manual and the entire assembly.



Use a reasonable force. The printed parts are tough, but not unbreakable. If it doesn't fit, check your approach twice.



**Most important: Enjoy the build, have fun.** Cooperate with your kids, friends or partners. However, we take no responsibility for possible fights ;)

## STEP 10 Optional parts

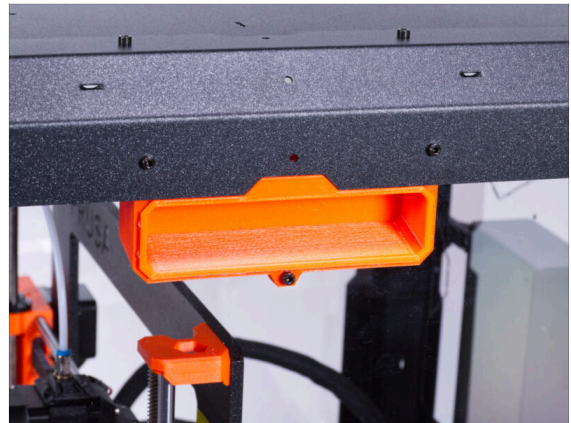

- We have designed enhancements that are not shipped by default in the kit, but you can print them out and add them to the enclosure during assembly. Fasteners are already included in the kit.

**⚠ Print out the parts before you start assembly.**

- To see the full list of the parts, please visit our collection at [Printables.com](https://www.prusa3d.com/Printables.com).

## STEP 11 Upgraded to MK4/S & MK3.9/S?

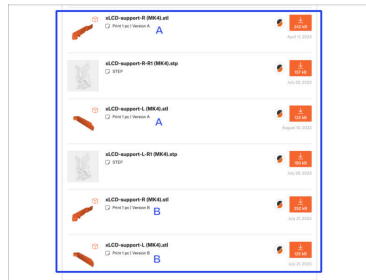
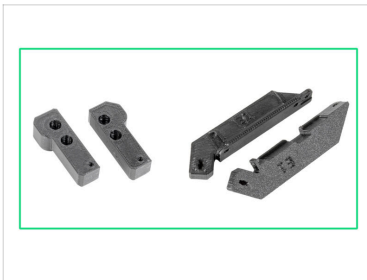

**i** If you've upgraded your printer to the MK4/S or MK3.9/S, you'll need to print a pair of xLCD supports for the Enclosure.

- First, print the xLCD supports. Then, proceed with the Enclosure assembly.

- You can find the xLCD support on our [Printables](https://www.prusa3d.com/Printables)

**i** Note: xLCD supports are available for the xLCD versions A and B, as described in the MK4 upgrade instructions (chapter xLCD assembly). The MK3.9 upgrade includes only version A.

## STEP 12 Add-ons

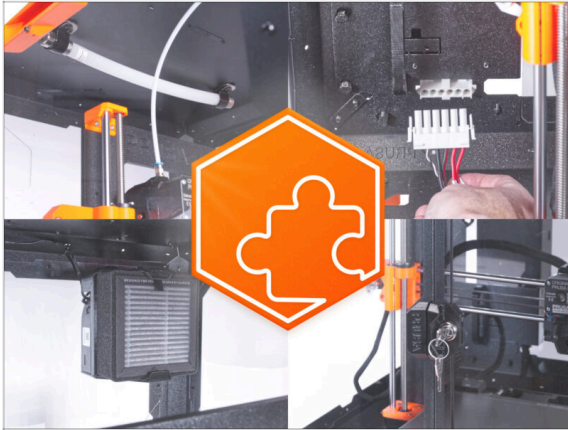

⚠ If you've purchased any of the add-ons together with the enclosure, **read all the chapters on the assembly of the enclosure and the specific add-on first.** Some steps must be omitted during the enclosure assembly and proceed with the add-on instruction.

ⓘ Because there can be possibly tens of different add-on combinations, there is no way to navigate you with a specific add-on installation directly from assembling the enclosure.

## STEP 13 Spool holder



- The instructions in this manual are intended for the original injection molded spool holder ("T" design) shipped with your printer.
- If you don't have the injection molded design, print the spool holder from our collection at [Printables.com](https://www.printables.com).

⚠ **Print out the part before you start assembly.**

## STEP 14 We are here for you!

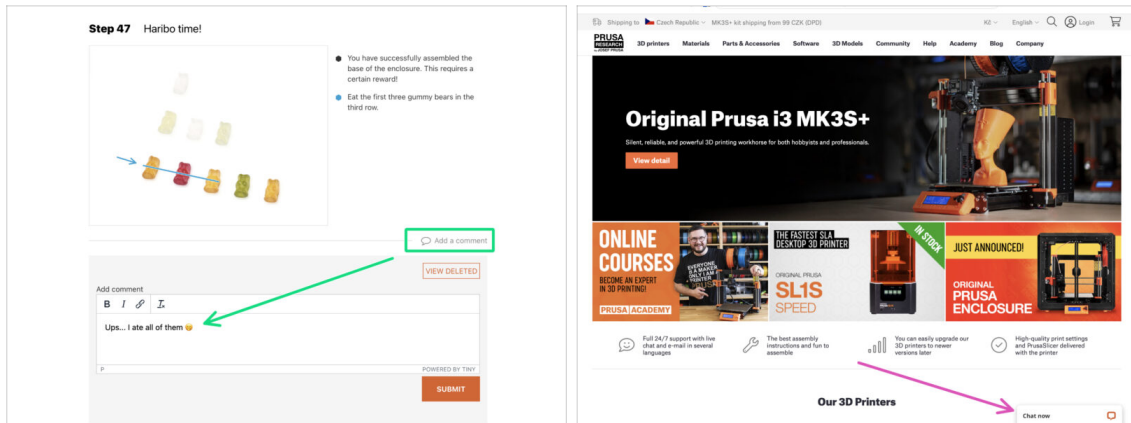

- Lost in the instructions? Missing screw or cracked printed part? **Let us know!**
- You can contact us using following channels:
  - Using comments under each step.
  - Using our 24/7 live chat at [prusa3d.com](https://prusa3d.com)
  - Writing an email to [info@prusa3d.com](mailto:info@prusa3d.com)

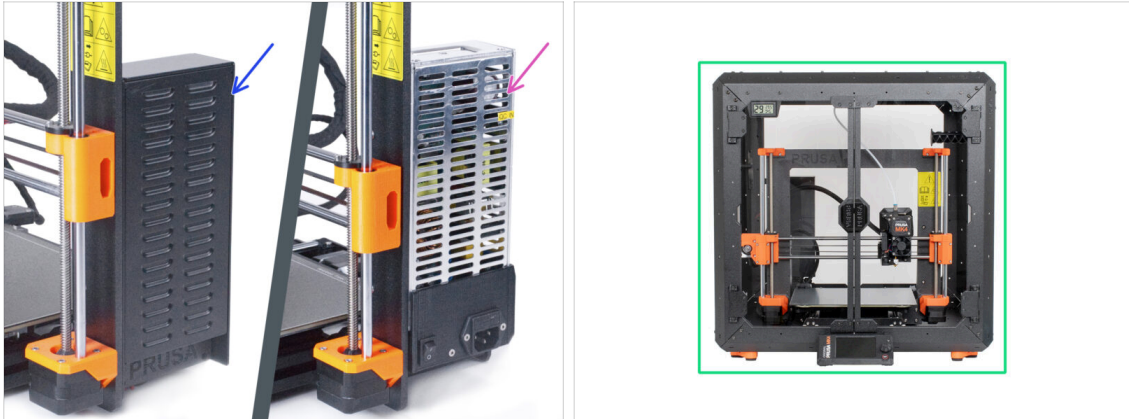
**STEP 15** MK3S+ or MK4/S & 3.9/S

- ⚠** Before beginning any partial disassembly of the printer, **ensure that you have printed all the necessary parts.**
- i** The MK3S+ has two types of the PSU (Power Supply Unit). There are different instructions for each type of the PSU.
- **Carefully check which type of the PSU you have on the printer and then choose the appropriate instructions:**
    - **MK3S+ Black PSU:** go to the next chapter **2A. Preparing the printer (MK3S+ Black PSU)**
    - **MK3S+ Silver PSU:** Before proceeding to the next chapter, print the SILVER-PSU-retainer. Download that part from [Printables.com](https://www.printables.com). Go to the next chapter **2B. Preparing the printer (MK3S+ Silver PSU)**
    - Got **MK4/S & 3.9/S**? Now follow the chapter **2C. Preparing the printer (MK4/S & 3.9/S)**



## 2A. Preparing the printer (MK4/S & 3.9/S)



## STEP 1 Tools necessary for this chapter



⬛ For the following steps, please prepare:

- 🟢 2.5mm Allen key
- 🟠 T10 Torx key
- 🟡 Needle-nose pliers *for cutting zip ties*
- 🔴 Piece of cloth or fabric (at least 15x15 cm) *for covering the heated bed*

## STEP 2 Preparing the printer

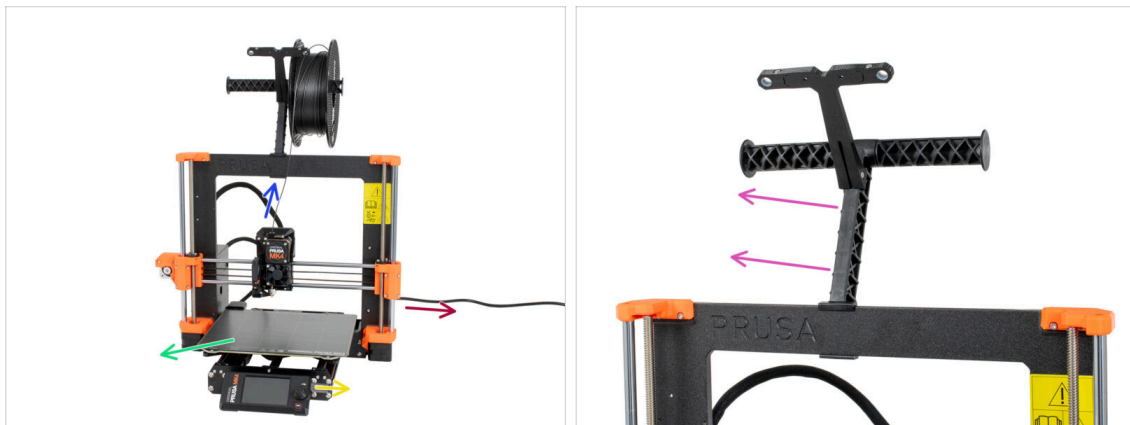

⚠ Before we start with partial disassembling of the printer, proceed with the following steps:

- 🟡 Unload the filament from the extruder.
- 🔴 Turn the printer off and unplug the power cable.
- 🟢 Remove the steel sheet from the heated bed.
- 🟠 Remove the USB flash disk.
- 🟡 Take off the filament spool from the spool holder and remove the spool holder from the printer.

### STEP 3 Disconnecting the xLCD cables

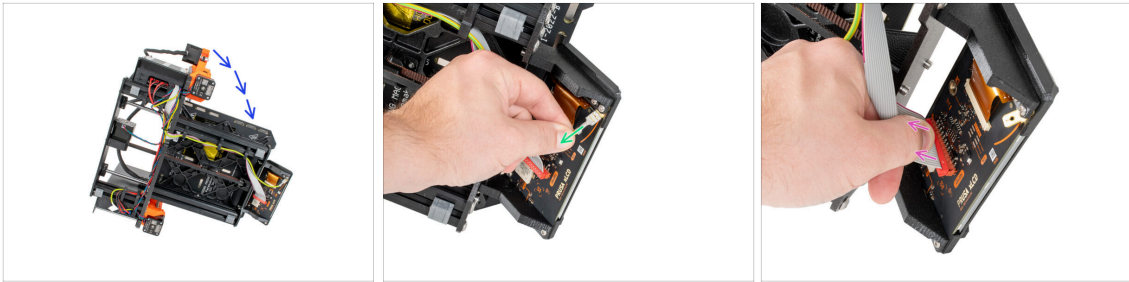

- ◆ Carefully turn the printer on its side (on the PSU).
- ◆ Disconnect the PE cable.
- ◆ Disconnect the xLCD cable.
- ⓘ You may have another version of the connected PE cable. Disconnect the PE and continue as instructed.

### STEP 4 Removing the xLCD cable clips

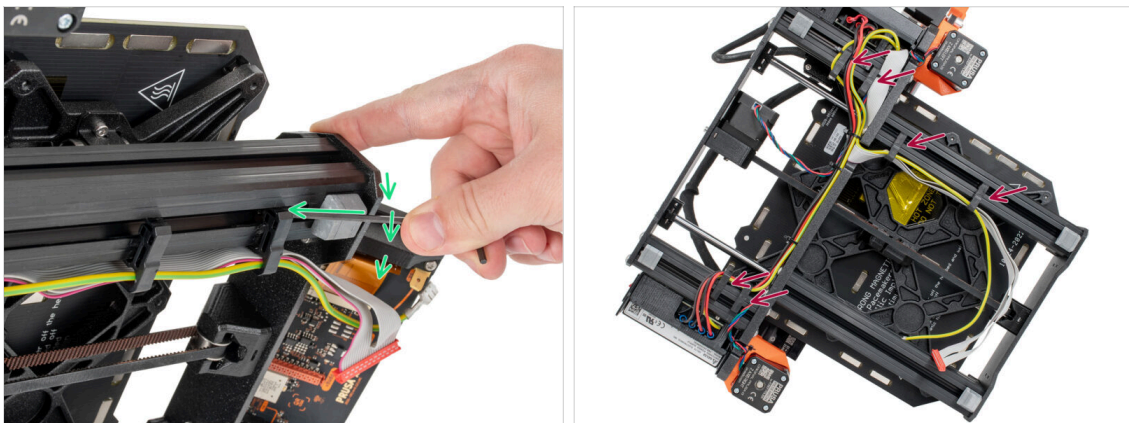

- ◆ Pry out the cable clips using a 2,5mm Allen key.
- ◆ Pry out and release all cable clips.
- ◆ Carefully remove the xLCD cables and the PE cable from the cable clips.

## STEP 5 Removing the xLCD cables

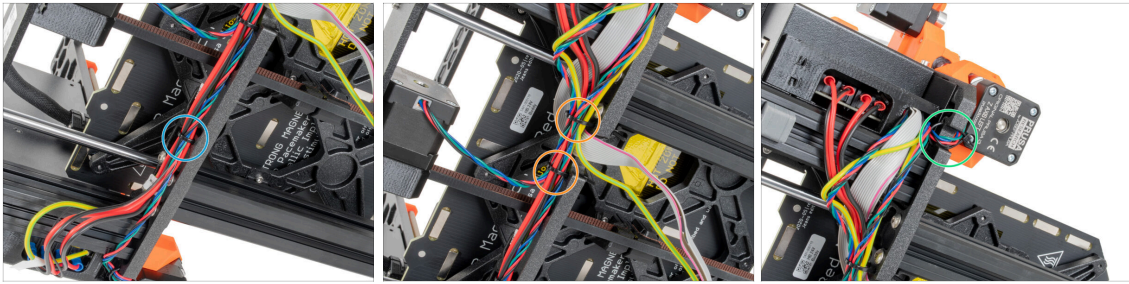

- Using the needle-nose pliers, cut the zip tie near the PSU. **Be careful not to cut the cables!**
- Follow the cable bundle up. Cut two zip ties securing the cable bundle over the xLCD cables.
- Cut remaining zip ties on the cable bundle. Their number may vary at this location.

## STEP 6 Removing the xLCD cables

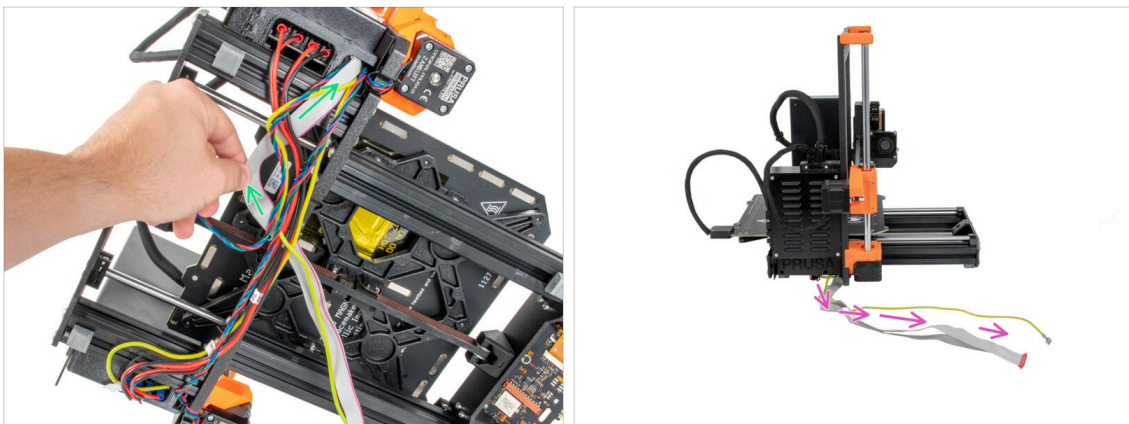

- Remove the xLCD cable and PE cable from the cable bundle.
- Put the printer back on its feet and leave the xLCD cable and PE cable free next to the printer.

**⚠ Avoid placing the printer on xLCD and PE cables!**

## STEP 7 Removing the xLCD

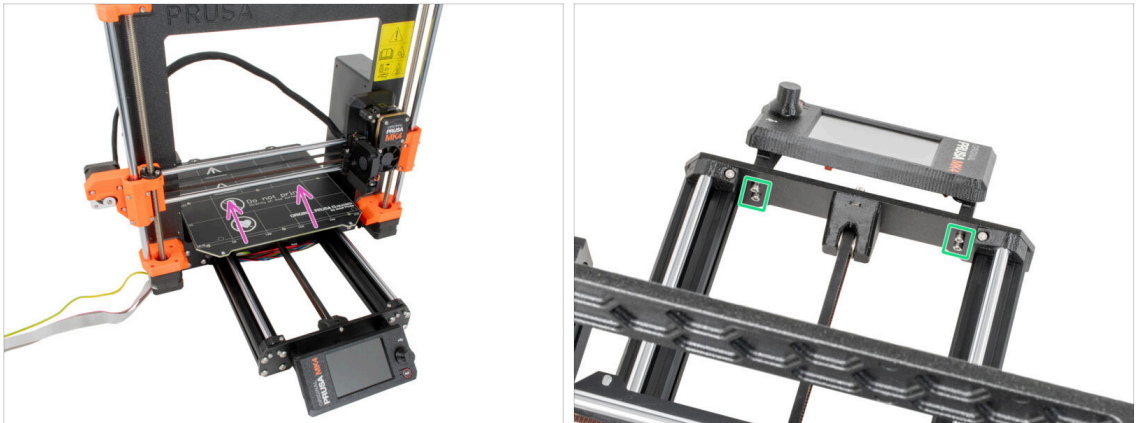

- ◆ Move the heatbed away from the xLCD.
- ◆ Release all four screws holding the xLCD in the front plate. Remove the xLCD from the printer.
- ⓘ Put the xLCD in a safe place for now. You'll need it again soon.

## STEP 8 Releasing the PSU

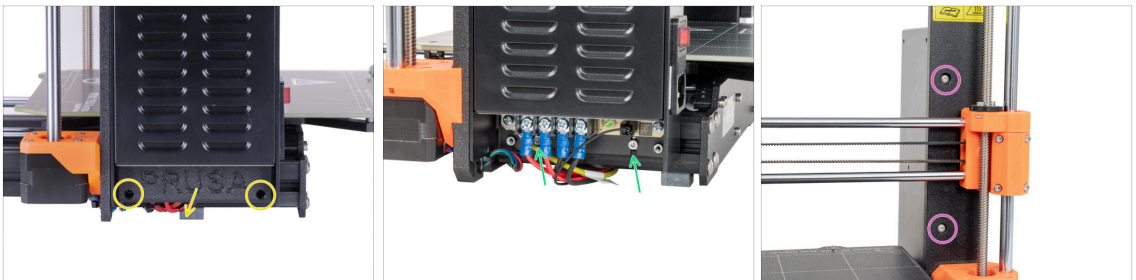

- ◆ Release two screws holding the PSU-cover and remove the cover from the PSU.
- ◆ Loosen two screws holding the PSU on the aluminum extrusion. **Do not remove them completely!** Keep them in place.
- ◆ Release two round head screws from the front side of the frame securing the PSU. **Do not throw them away!**
- ⓘ If one of the screws is hidden behind the X-end, manually rotate both threaded rods at the same time to move the X-axis up or down.

## STEP 9 Removing the PSU

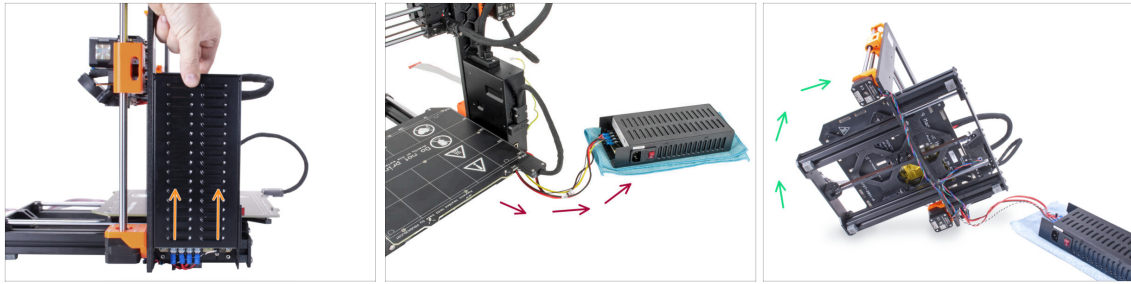

- Slightly lift the PSU until it can be completely released from the printer.
- Remove the PSU from the printer and place it behind the back of the printer on the piece of cloth, like in the picture.
- ⓘ You will need to slightly lift the printer to guide the cables out of the frame.
- Carefully turn the printer on the "electronics" side.
- ⚠ **Avoid putting the printer on the LCD cables!**

## STEP 10 Guiding the cables: parts preparation





- For the following steps, please prepare:
  - Zip tie (3x)

## STEP 11 Guiding the cables





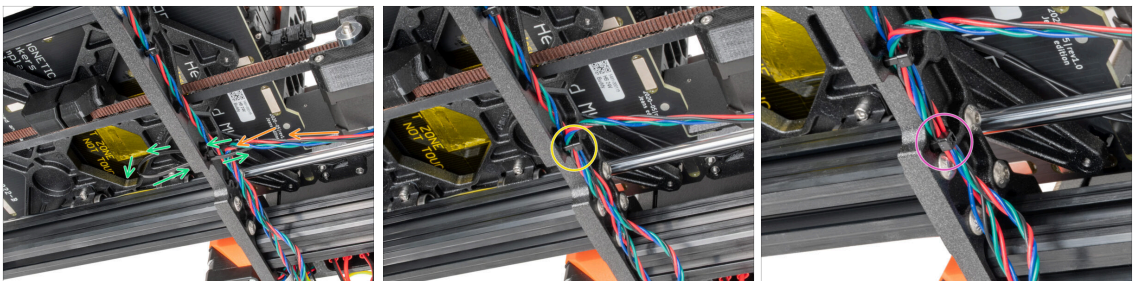

 In the upcoming steps, **please tighten all zip ties carefully**, as you might pinch/break the cables.

-  Locate the circular holes in the frame near the Z-axis right motor.
-  Slide the zip tie through the circular holes in the frame to create a loop.
-  Guide the motor cable in the zip tie and tighten it. Be careful not to over tighten the tie as it can cut the wires. Cut the remaining part.

## STEP 12 Guiding the cables



-  Continue downwards and using another zip tie create the next loop.
-  Insert Y-axis motor cable to the current bundle.
-  Push the cable gently in the zip tie and tighten it so it is snug and holding the wires. Be careful not to over tighten the tie as it can cut the wires . Cut the remaining part.
-  Following the cables and secure the bundle with the zip tie in the next couple of holes.

### STEP 13 Mounting the printer frame support: part preparation



- ◆ For the following steps, please prepare:
- ◆ Printer frame support (1x)
- ◆ M4x10r screw (2x) *previously removed from the PSU*

### STEP 14 Mounting the printer frame support

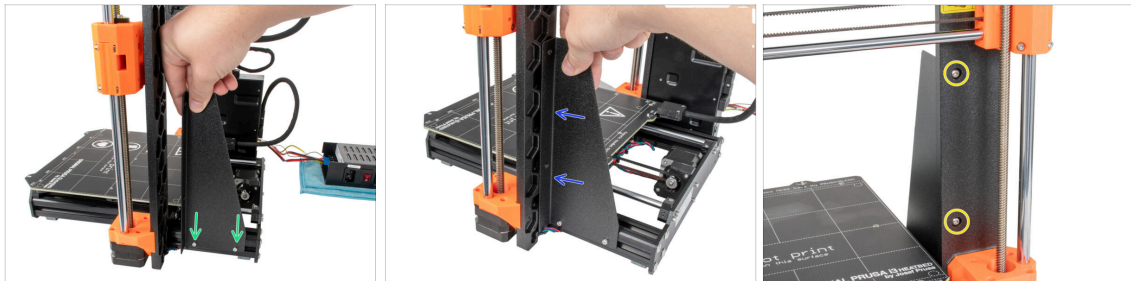

- ◆ Slide the printer frame support on the screws in the aluminum extrusions (instead of the PSU).
- ◆ Move the printer frame support to the frame.
- ◆ Secure the printer frame support to the frame with two M4x10r screws.



### STEP 15 Mounting the printer frame support

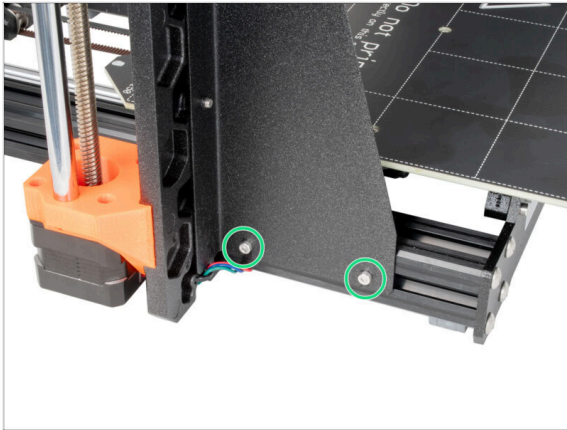

- ◆ Fully tighten the screws on the printer frame support.

### STEP 16 Covering the PSU cables: parts preparation



◆ For the following steps, please prepare:

⚠ **There are two textile sleeves in your kit with different lengths and diameters.**

- ◆ Textile sleeve 8 x 350 mm (1x)
- ◆ Zip tie (2x)

## STEP 17 Covering the PSU cables

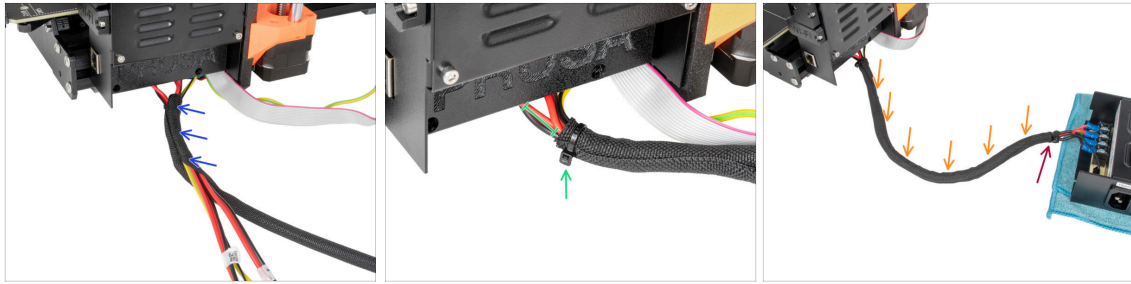

- ◆ From the electronics, wrap the PSU cable (including the black&white power panic cable and the green&yellow PE cable) in the textile sleeve.
- ◆ Leave 2-5 cm from the electronics uncovered. Secure the end of the sleeve with the zip tie.
- ◆ Wrap the entire length of the bundle and slightly twist the sleeve, **not the cables**.
- ◆ Secure the end of the sleeve with the zip tie.

## STEP 18 Covering the xLCD cables: parts preparation



- ◆ **For the following steps, please prepare:**
  - ◆ Textile sleeve 13 x 400 mm (1x)
  - ◆ Zip tie (1x)

## STEP 19 Covering the xLCD cables

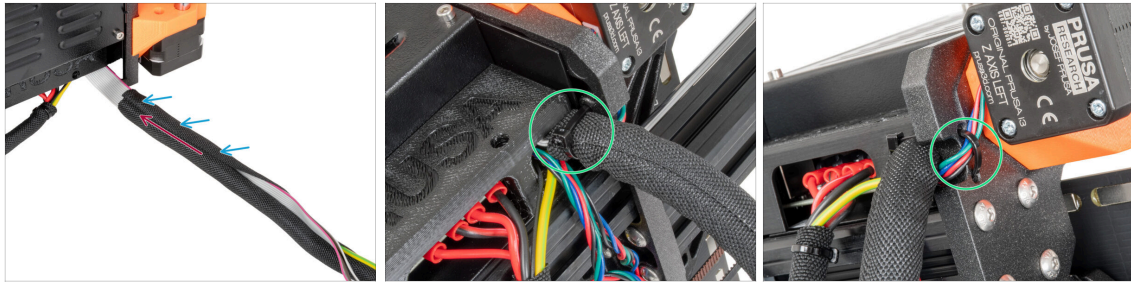

- ➊ From the electronics, wrap the xLCD and PE cables in the textile sleeve.
- ➋ Push the textile sleeve near to the electronics box.
- ➌ Wrap the entire length of the xLCD cable bundle.
- ➍ Using the zip tie, create a loop through the circle holes in the frame around the motor cables and xLCD cable bundle.

⚠ **Do not forget to include the Z-axis left motor cable on the front side of the frame! See the detail.**

## STEP 20 QSM fitting: parts preparation



- ➎ **For the following steps, please prepare:**
  - ➏ Fitting QSM-M5 (1x)
- ⓘ Starting from September 2024, you may receive a new black Fitting M5-4. The assembly and functionality remain identical to the blue one.

## STEP 21 Installing the QSM fitting



- Insert and screw the Fitting QSM-M5 directly into the threaded filament hole in the extruder.

## STEP 22 MK4S xLCD: parts preparation

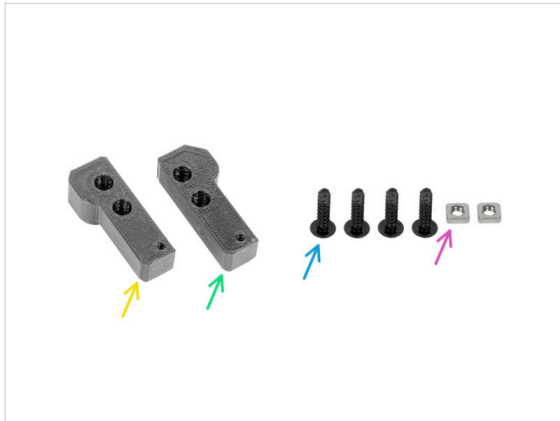

**i** Your MK4S or MK3.9S may have a printed or injection molded xLCD cover. **The following steps are for the injection molded version.** If you have the printed cover, go to **Version A: Disassembling the xLCD**

**For the next steps, please prepare:**

- xLCD assembly (1x)
- xLCD-adapter\_L (1x)
- xLCD-adapter\_R (1x)
- 3x12sT screw (4x) *removed in previous steps*
- M3nS nut (2x)

## STEP 23 MK4S xLCD adapters preparation



- Insert one M3nS nut into xLCD-adapter\_R.
- Insert one M3nS nut into xLCD-adapter\_L.
- Insert four 3x12sT screws into the adapters and tighten them with a few turns.

## STEP 24 MK4S adapters securing



- Attach the xLCD-adapter\_R and secure two 3x12sT screw using a T10 Torx key.
- Attach the xLCD-adapter\_L and secure two 3x12sT screws using a T10 Torx key.
- Good job, the MK4S xLCD assembly is prepared.

## STEP 25 Version A: Disassembling the xLCD

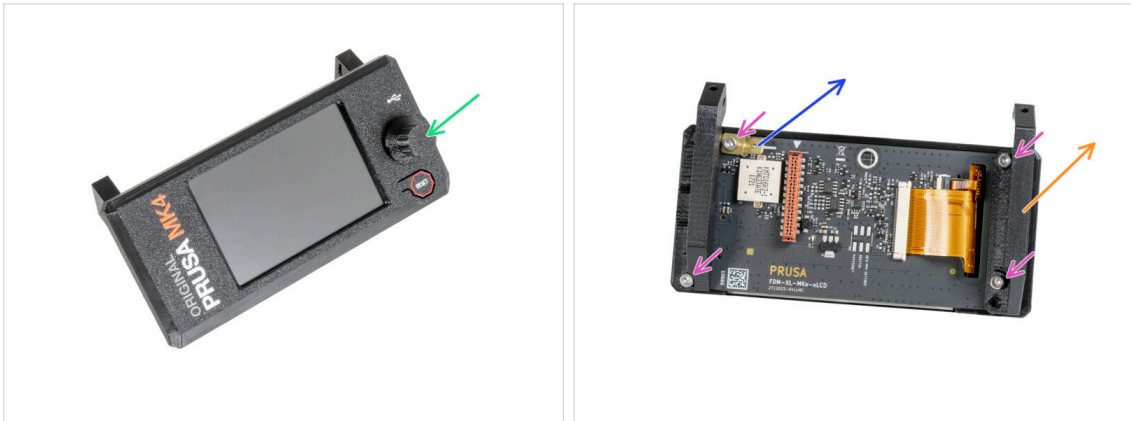

- Remove the xLCD-knob and keep it for later use.
- Release four M3x8 screws securing the xLCD board.
- Take off the xLCD-support-left.
- Take off the PE Faston 6.3x0.8 and keep it for later.

## STEP 26 Version B: Disassembling the xLCD



- Remove the xLCD-knob and keep it for later use.
- Release five M3x8rT screws securing the xLCD board.
- Take off the xLCD-support-left.
- Take off the PE Faston 6.3x0.8 and keep it for later.

### STEP 27 Version A: Disassembling the xLCD



- ◆ Gently pull out the second xLCD support, it will pull out the xLCD from the xLCD cover.
- ◆ Notice there is a small hook that goes around the circuit board.

### STEP 28 Version B: Disassembling the xLCD



- ◆ Gently pull out the second xLCD support, it will pull out the xLCD from the xLCD cover.
- ◆ Notice there is a small hook that goes around the circuit board.

**STEP 29** Preparing the xLCD: parts preparation

**i** For the **injection molded xLCD on the MK4S** are required new supports. Do not mix the old and new parts! The new xLCD brackets can be downloaded from [Printables.com](https://www.printables.com)

**◆** For the following steps, please prepare:

- ◆** xLCD-cover (1x) *old part*
- ◆** xLCD screen (1x) *old part*
- ◆** xLCD-knob (1x) *old part*
- ◆** xLCD-support-L-MK4 (1x)
- ◆** xLCD-support-R-MK4 (1x)

**i** The list continues in the next step...

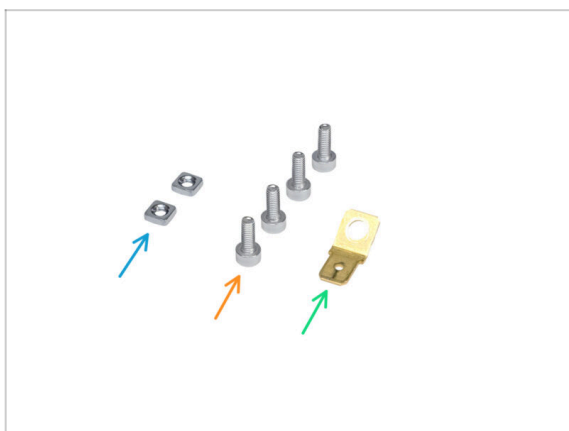
**STEP 30** Version A: Preparing the xLCD: parts preparation

- ◆** M3nS nut (2x)
- ◆** M3x8 screw (4x) previously removed
- ◆** PE Faston 6.3x0.8 (1x) old part



### STEP 31 Version B: Preparing the xLCD: parts preparation



- M3nS nut (2x)
- M3x8rT screw (5x) previously removed
- PE Faston 6.3x0.8 (1x) old part

### STEP 32 Preparing the xLCD



- Insert all the way of the M3nS nut into each xLCD-support.

**i** You may use a 2.5 mm Allen key to push the nuts into the xLCD supports.

**⚠** During handling, be careful that the nuts do not fall out of the parts.

### STEP 33 Version A: Preparing the xLCD



- ◆ Insert the xLCD-support-right on an xLCD.
- ◆ Notice there is a small hook that goes around the circuit board.
- ◆ Insert the xLCD screen with the support all the way in the xLCD-cover.
- ◆ Attach the xLCD-support-left on the xLCD board and align it with two holes in the board.
- ◆ Secure the xLCD support with three M3x8 screws.

### STEP 34 Version B: Preparing the xLCD



- ◆ Insert the xLCD-support-right on an xLCD.
- ◆ Notice there is a small hook that goes around the circuit board.
- ◆ Insert the xLCD screen with the support all the way in the xLCD-cover.
- ◆ Attach the xLCD-support-left on the xLCD board and align it with three holes in the board.
- ◆ Secure the xLCD support with three M3x8rT screws.

### STEP 35 Version A: Installing the PE Faston

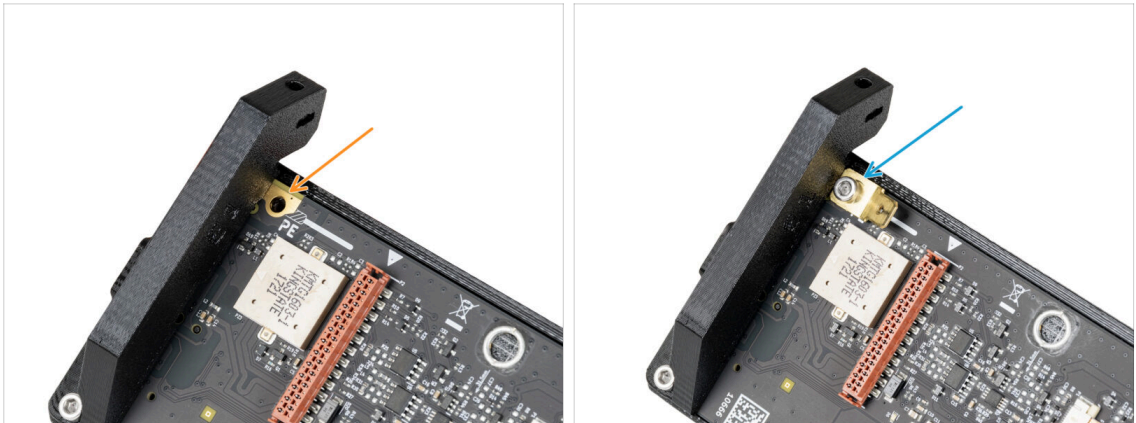

- 🟠 Locate the PE hole on the xLCD next to the xLCD-support-right.
- 🟡 Insert the M3x8 and PE faston and secure it with a 2.5mm Allen key.

### STEP 36 Version B: Installing the PE Faston

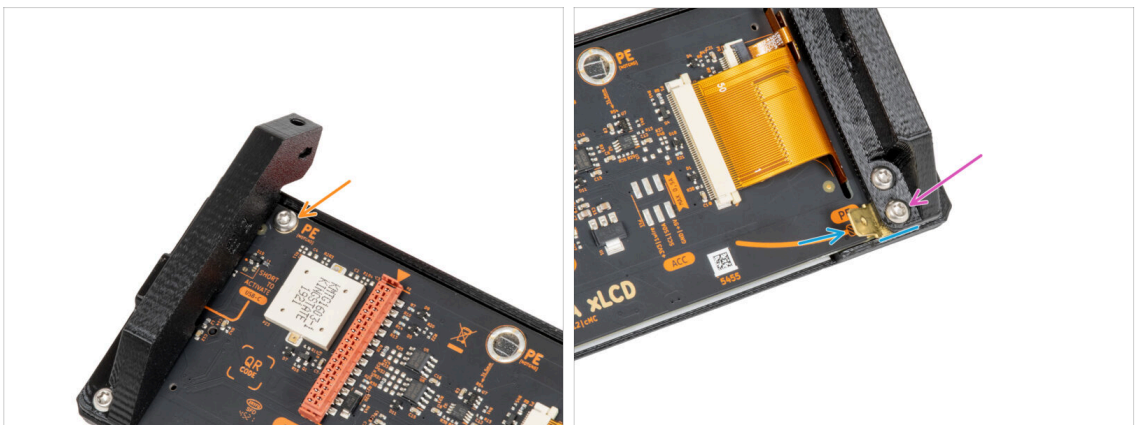

- 🟠 Insert the M3x8rT screw into the PE hole and secure it.
- 🟡 Insert the PE Faston between the xLCD-support-left and the xLCD board. Align it with the hole and point the PE Faston slightly diagonally as you see in the picture.
- 🟣 Secure all parts together with one M3x8rT screw.

### STEP 37 Assembling the LCD knob



- Attach the xLCD-knob on the encoder.
- i** Knob mounting orientation doesn't matter.

### STEP 38 Haribo time!



- That was easy, wasn't it? Reward yourself and replenish your energy for the next chapter.
- Eat the second row of the gummy bears. Leave the others!

## STEP 39 The printer is prepared

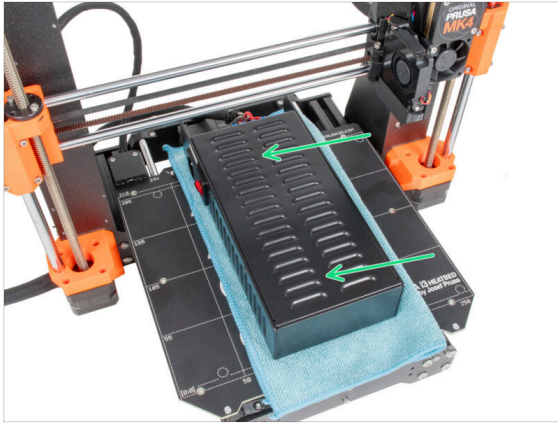

- ◆ Carefully place the PSU on the heatbed. Use a piece of cloth as protection.
- ◆ **Well done, the printer is prepared.**
- ⓘ Place the printer aside for some time, we will need it later on.
- ◆ Now, let's go to the next chapter: **3. Assembling the enclosure**

## 2B. Preparing the printer (MK3S+ Black PSU)



## STEP 1 Tools necessary for this chapter



◆ For the following steps, please prepare:

- ◆ 2.5mm Allen key
- ◆ Needle-nose pliers *for cutting zip ties*
- ◆ Piece of cloth or fabric (at least 15x15 cm) *for covering the heated bed*

## STEP 2 Preparing the printer

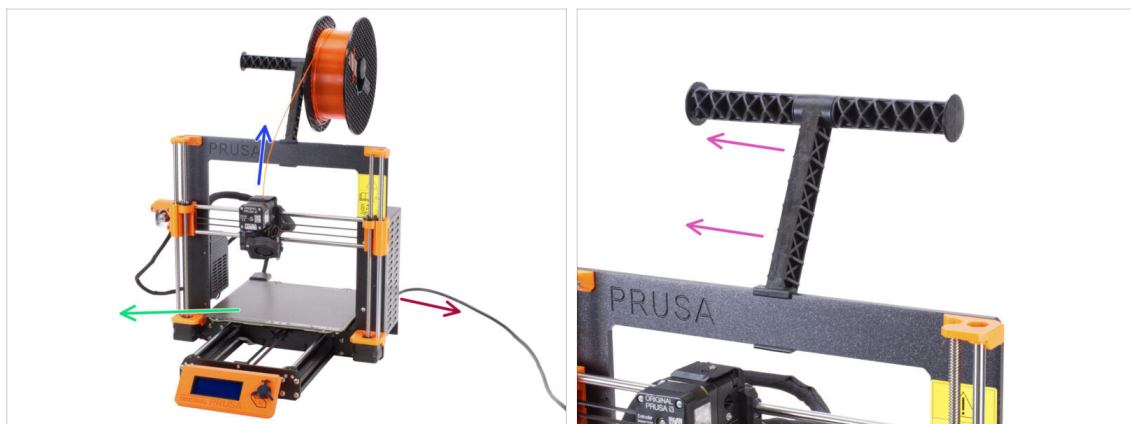

⚠ Before we start with partial disassembling of the printer, proceed with the following steps:

- ◆ Unload the filament from the extruder.
- ◆ Turn the printer off and unplug the power cable.
- ◆ Remove the steel sheet from the heated bed.
- ◆ Take off the filament spool from the spool holder and remove the spool holder from the printer.

### STEP 3 Disconnecting the LCD cables



- ◆ Carefully turn the printer on its side (on the PSU).
- ◆ Disconnect both LCD cables from the LCD board.
- ◆ Very carefully remove the LCD cables from the aluminum frame extrusion. **Do not pull on the cable!**

### STEP 4 Removing the LCD cables

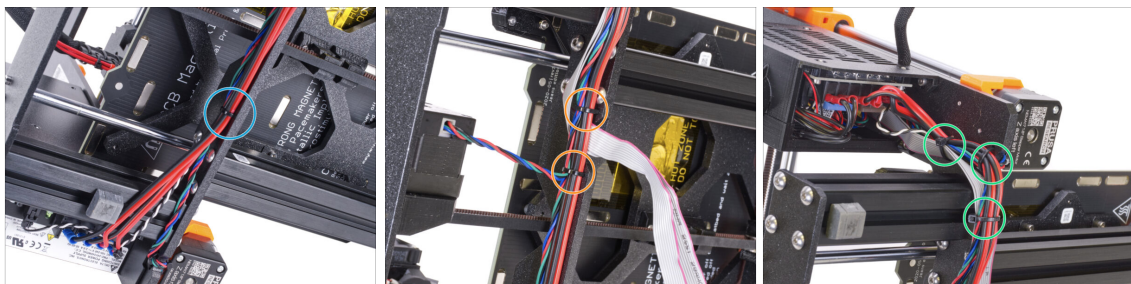

- ◆ Using the needle-nose pliers, cut the zip tie near the PSU. **Be careful not to cut the cables!**
- ◆ Follow the cable bundle up. Cut two zip ties securing the cable bundle over the LCD cables.
- ◆ Cut remaining zip ties on the cable bundle. Their number may vary at this location.



## STEP 5 Removing the LCD cables

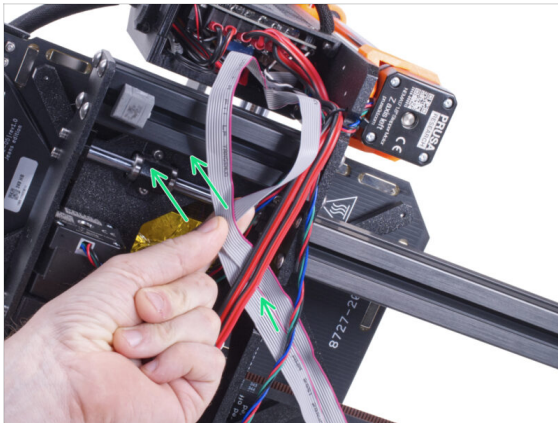

- ◆ Remove the LCD cables from the cable bundle.
- ◆ Put the printer back on its feet and leave the LCD cables free next to the printer.
- ⚠ **Avoid placing the printer on LCD cables!**

## STEP 6 Removing the LCD

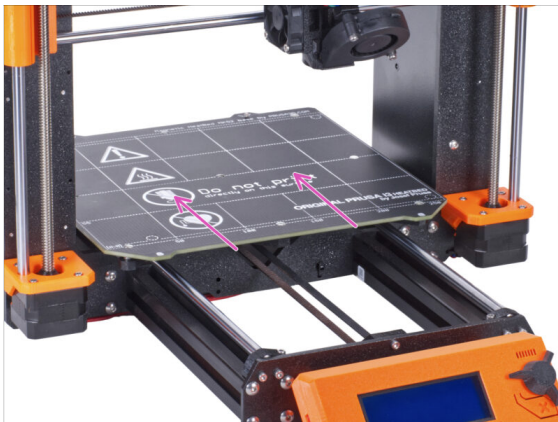

- ◆ Move the heatbed away from the LCD.
- ◆ Release all four screws holding the LCD in the front plate. Remove the LCD from the printer.
- ⓘ Put the LCD in a safe place for now. You'll need it again soon.

## STEP 7 Releasing the PSU

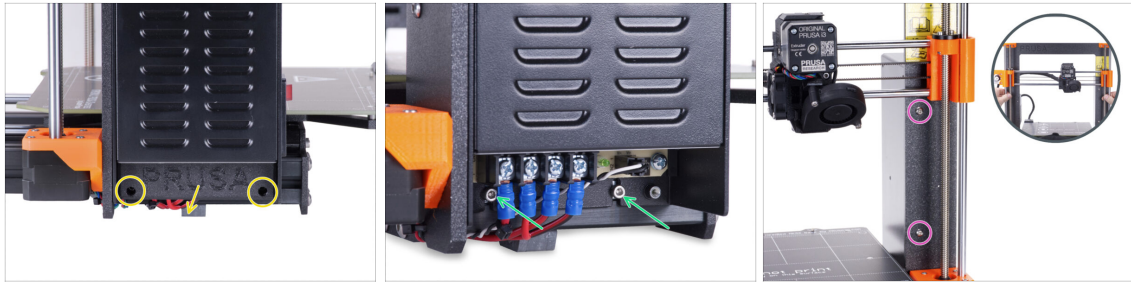

- ◆ Release two screws holding the PSU-cover and remove the cover from the PSU.
- ◆ Loosen two screws holding the PSU on the aluminum extrusion. **Do not remove them completely!** Keep them in place.
- ◆ Release two round head screws from the front side of the frame securing the PSU.  
**i** If one of the screws is hidden behind the X-end, manually rotate both threaded rods at the same time to move the X-axis up or down.

## STEP 8 Removing the PSU

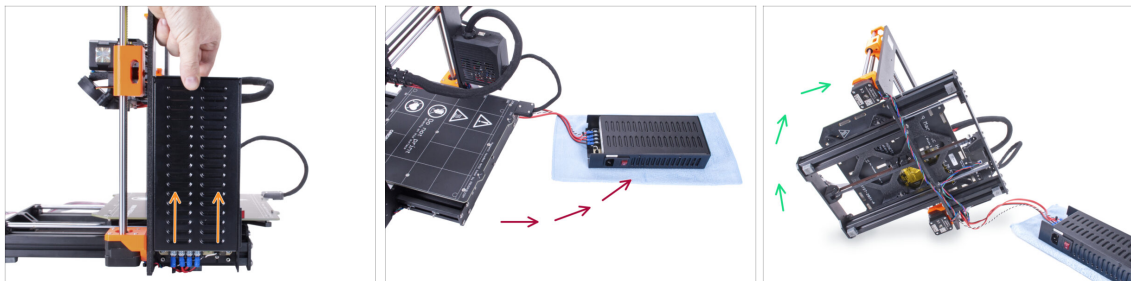

- ◆ Slightly lift the PSU until it can be completely released from the printer.
- ◆ Remove the PSU from the printer and place it behind the back of the printer on the piece of cloth, like in the picture.  
**i** You will need to slightly lift the printer to guide the cables out of the frame.
- ◆ Carefully turn the printer on the "electronics" side.  
**⚠ Avoid putting the printer on the LCD cables!**

## STEP 9 Guiding the cables: parts preparation



◆ For the following steps, please prepare:

- ◆ Zip tie (3x)

## STEP 10 Guiding the cables



⚠ In the upcoming steps, **please tighten all zip ties carefully**, as you might pinch/break the cables.

- ◆ Locate the circular holes in the frame near the Z-axis right motor.
- ◆ Slide the zip tie through the circular holes in the frame to create a loop.
- ◆ Guide the motor cable in the zip tie and tighten it. Be careful not to over tighten the tie as it can cut the wires. Cut the remaining part.

## STEP 11 Guiding the cables

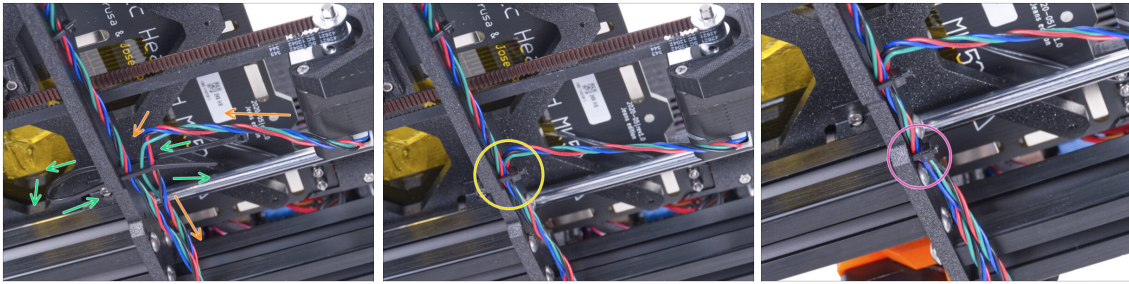

- Continue downwards and using another zip tie create the next loop.
- ➦ Insert Y-axis motor cable to the current bundle.
- Push the cable gently in the zip tie and tighten it so it is snug and holding the wires. Be careful not to over tighten the tie as it can cut the wires . Cut the remaining part.
- Following the cables and secure the bundle with the zip tie in the next couple of holes.

## STEP 12 Mounting the printer frame support: part preparation



- **For the following steps, please prepare:**
- Printer frame support (1x)
- M4x10r screw (2x) *previously removed from the PSU*

### STEP 13 Mounting the printer frame support

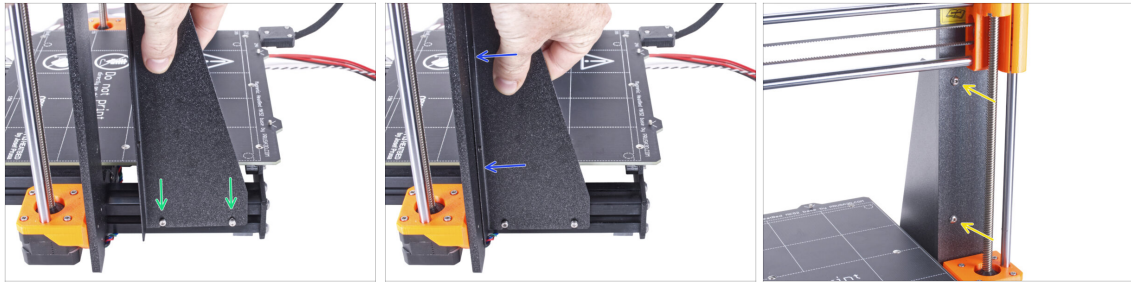

- Slide the printer frame support on the screws in the aluminum extrusions (instead of the PSU).
- Move the printer frame support to the frame.
- Secure the printer frame support to the frame with two M4x10r screws.

### STEP 14 Mounting the printer frame support

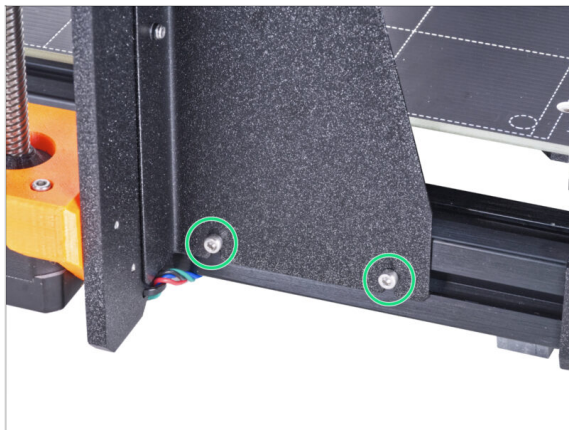

- Fully tighten the screws on the printer frame support.

## STEP 15 Covering the PSU cables: parts preparation



● For the following steps, please prepare:

⚠ **There are two textile sleeves in your kit with different lengths and diameters.**

- Textile sleeve 8 x 350 mm (1x)
- Zip tie (2x)

## STEP 16 Covering the PSU cables

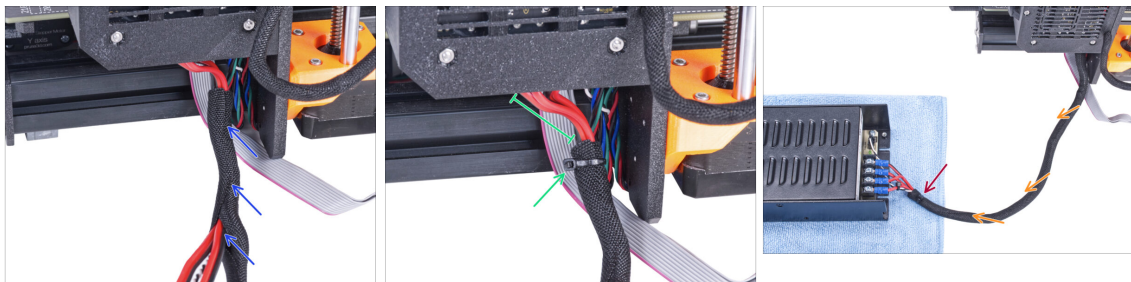

- From the electronics, wrap the PSU cable (including the black&white power panic cable) in the textile sleeve.
- Leave 2-5 cm from the electronics uncovered. Secure the end of the sleeve with the zip tie.
- Wrap the entire length of the bundle and slightly twist the sleeve, **not the cables**.
- Secure the end of the sleeve with the zip tie.

## STEP 17 Covering the LCD cables: parts preparation

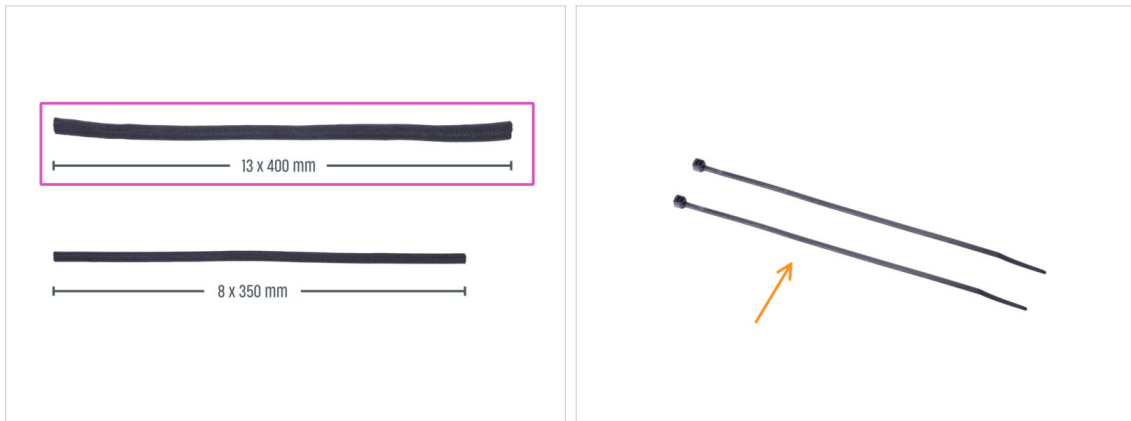

For the following steps, please prepare:

- Textile sleeve 13 x 400 mm (1x)
- Zip tie (2x)

## STEP 18 Covering the LCD cables

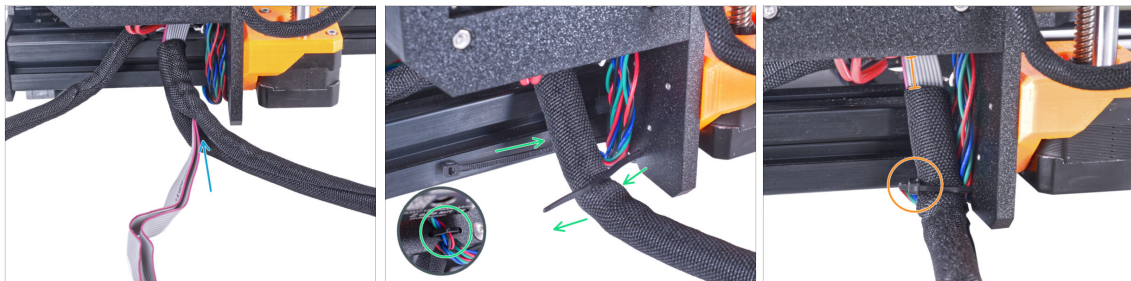

- From the electronics, wrap the LCD cables in the textile sleeve.
- Wrap the entire length of the LCD cable bundle.
- Using the zip tie, create a loop through the circle holes in the frame around the motor cables and LCD cable bundle.
- ⚠ Do not forget to include the Z-axis left motor cable on the front side of the frame! See the detail.**
- Leave 2-5 cm from the electronics uncovered. Secure the cable bundle with the zip tie. **Do not over tighten the bundle!** You may cut the cables.

## STEP 19 Securing the cables

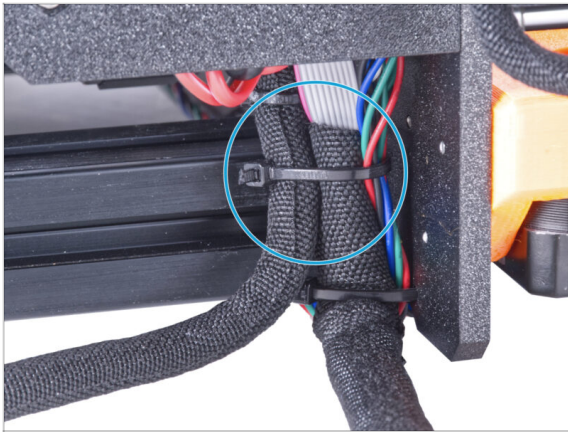

- ◆ Merge the LCD cable bundle and the PSU cable bundle and secure them together with the zip tie.

⚠ **Do not over tighten the zip tie! It can damage the cables.**

## STEP 20 Removing the FS-cover

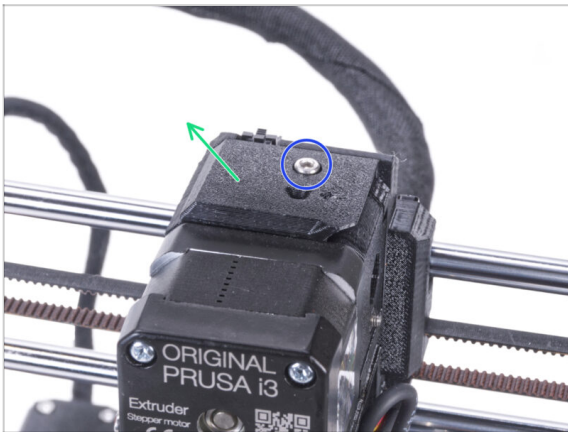

ⓘ The following procedure is intended for a single material printer. If you have a multi material printer, go to [Disassembling the LCD](#).

- ◆ Release the M3x10 screw securing the FS-cover and keep it aside. We will need it again later on.
- ◆ Remove the FS-cover from the extruder.



## STEP 21 Installing the new FS-cover: parts preparation



- ◆ **For the following steps, please prepare:**
- ◆ New FS-cover (1x)
- ⚠ **Note, that the new FS-cover differs from the old one for the MK3S+. It has a brass insert.**
- ◆ M3x10 screw (1x) *re-use the old one*
- ◆ Fitting QSM-M5 (1x)

## STEP 22 Installing the new FS-cover



- ◆ Attach the new FS-cover on the extruder. See the correct orientation. The beveled side must be on the right (above the extruder-idler).
- ◆ Secure it with the M3x10 screw.
- ◆ Screw the fitting into the brass insert in the FS-cover. No need to use a side wrench.

## STEP 23 Disassembling the LCD

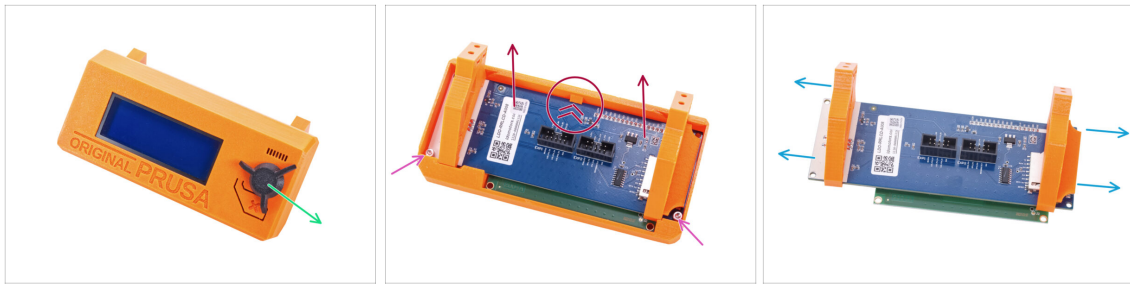

- Remove the SD card from the LCD assembly.
- Remove the LCD knob and keep it for later use.
- Release two M3x10 screws securing the LCD screen.
- Slightly push the latch on the LCD cover and remove the LCD screen.
- Slide off the LCD supports from the LCD screen.

## STEP 24 Preparing the LCD: parts preparation



- **For the following steps, please prepare:**
- LCD-support-L-MK3S+ (1x)
- LCD-support-R-MK3S+ (1x)
- M3nS nut (2x)
- M3x10 screw (2x) *previously removed*
- LCD-cover (1x) *old part*
- LCD screen (1x) *old part*
- LCD-knob (1x) *old part*

## STEP 25 Preparing the LCD



- Insert all the way the M3x10 nut into each LCD-support.
- ⚠ During handling, be careful that the nuts do not fall out of the parts.

## STEP 26 Preparing the LCD

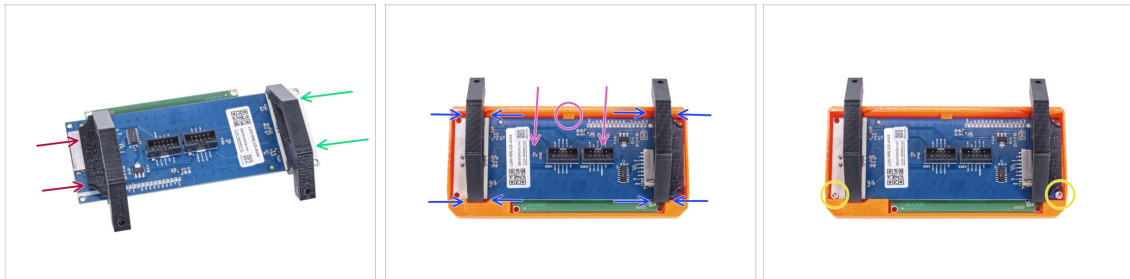

- Slide the LCD-support-L from the left side of the LCD board (side with the SD card slot) to approximately the same position as in the picture.
- Slide the LCD-support-R from the right side to approximately the same position as in the picture.
- Insert the LCD screen with the supports all the way in the LCD-cover. The LCD controller must click under support in the center of the LCD-cover.
- Adjust the position of the supports if needed. It must fit in the cutouts.
- Secure the LCD with two M3x10 screws.

## STEP 27 Assembling the LCD knob



- Attach the LCD-knob on the encoder.
- ⓘ Knob mounting orientation doesn't matter.

## STEP 28 Haribo time!



- That was easy, wasn't it? Reward yourself and replenish your energy for the next chapter.
- Eat the second row of the gummy bears. Leave the others!

## STEP 29 The printer is prepared

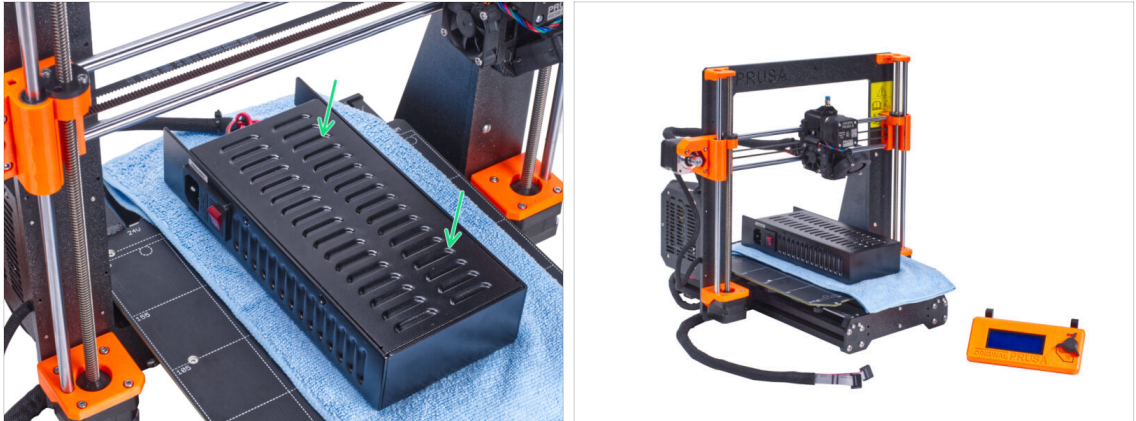

- ◆ Carefully place the PSU on the heatbed. Use a piece of cloth as protection.
- ◆ **Well done, the printer is prepared.**
- ⓘ Place the printer aside for some time, we will need it later on.
- ◆ Now, let's go to the next chapter: **3. Assembling the enclosure**

## 2C. Preparing the printer (MK3S+ Silver PSU)

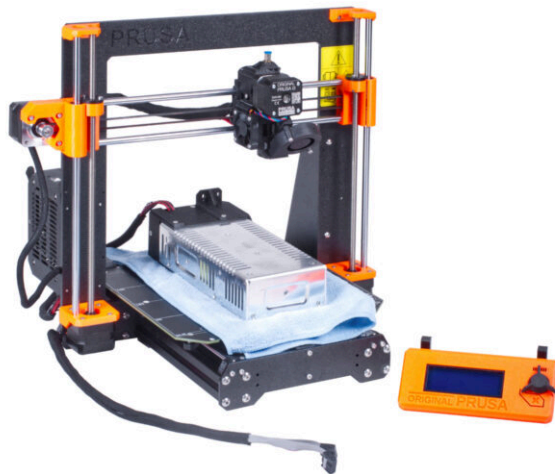

## STEP 1 Tools necessary for this chapter



⬛ For the following steps, please prepare:

- 🟢 2.5mm Allen key
- 🟡 3.0mm Allen key
- 🟦 Needle-nose pliers *for cutting zip ties*
- 🟤 Piece of cloth or fabric (at least 15x15 cm) *for covering the heated bed*

## STEP 2 Preparing the printer

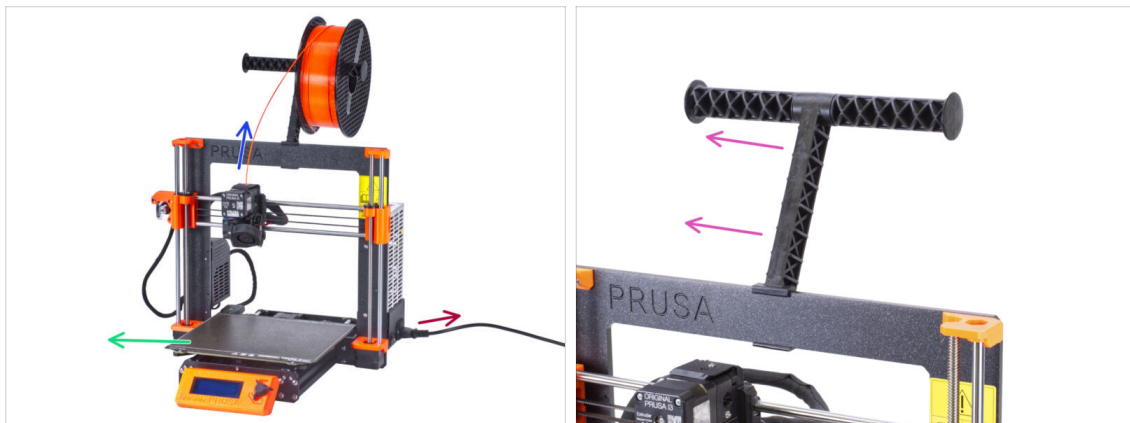

⚠ Before we start with partial disassembling of the printer, proceed with the following steps:

- 🟦 Unload the filament from the extruder.
- 🟤 Turn the printer off and unplug the power cable.
- 🟢 Remove the steel sheet from the heated bed.
- 🟡 Take off the filament spool from the spool holder and remove the spool holder from the printer.

### STEP 3 Disconnecting the LCD cables



- ◆ Carefully turn the printer on its side (on the PSU).
- ◆ Disconnect both LCD cables from the LCD board.
- ◆ Very carefully remove the LCD cables from the aluminum frame extrusion. **Do not pull on the cable!**

### STEP 4 Removing the LCD cables

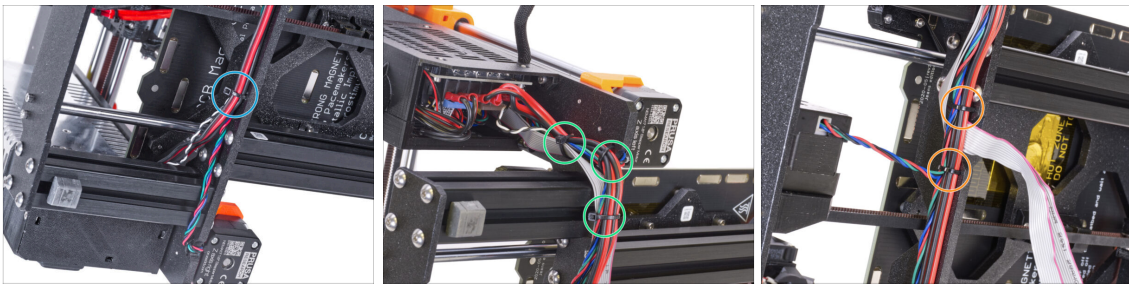

- ◆ Using the needle-nose pliers, cut the zip tie near the PSU. **Be careful not to cut the cables!**
- ◆ Follow the cable bundle up. Cut two zip ties securing the cable bundle over the LCD cables.
- ◆ Cut remaining zip ties on the cable bundle. Their number may vary at this location.



## STEP 5 Removing the LCD cables

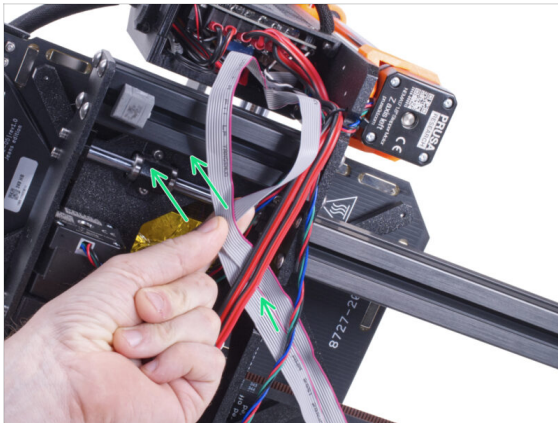

- Remove the LCD cables from the cable bundle.
- Put the printer back on its feet and leave the LCD cables free next to the printer.
- ⚠ Avoid placing the printer on LCD cables!**

## STEP 6 Removing the LCD

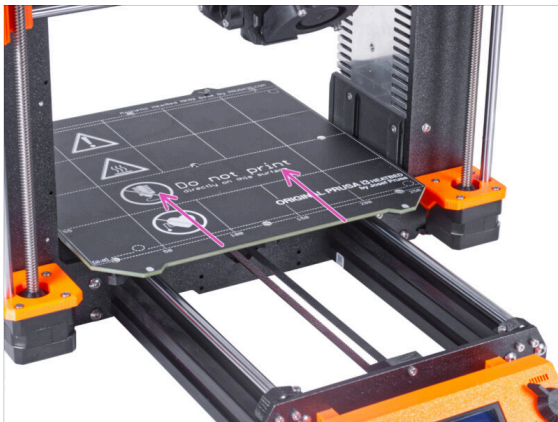

- Move the heatbed away from the LCD.
- Release all four screws holding the LCD in the front plate. Remove the LCD from the printer.
- i** Put the LCD in a safe place for now. You'll need it again soon

## STEP 7 Releasing the PSU

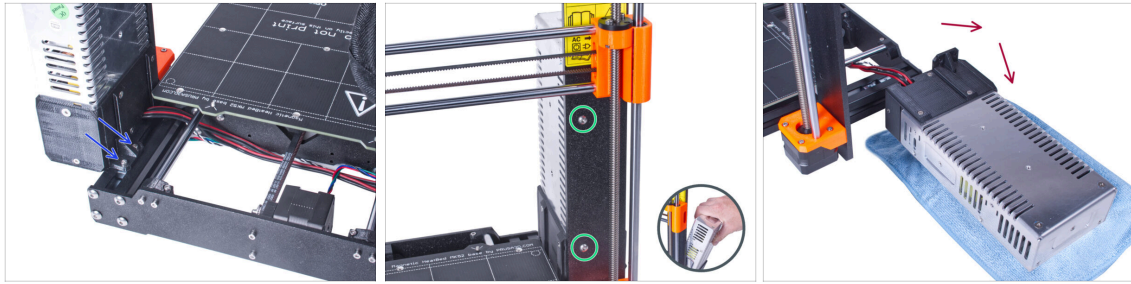

- ◆ Turn the printer and from the rear side of the printer, release two screws securing the PSU on the short aluminum extrusion.
- ◆ Turn the printer with the front side facing you and release two screws securing the PSU to the frame. **Hold the PSU to prevent it from falling.**
- ◆ Carefully place the PSU next to the printer on a piece of cloth to avoid damaging the PSU or work surface.

## STEP 8 Removing the short extrusion

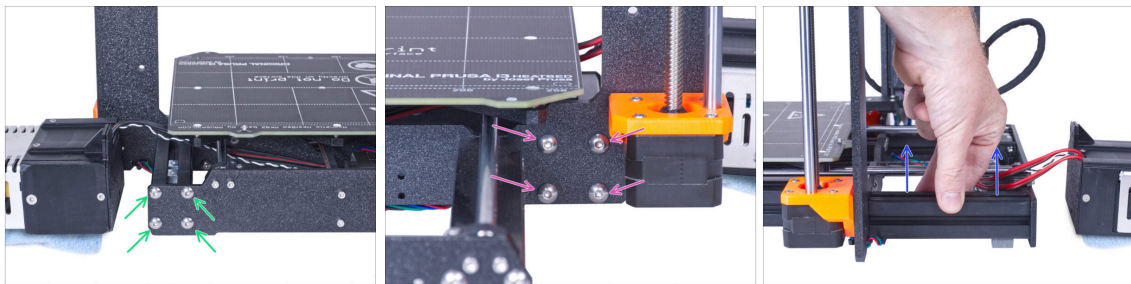

- ◆ From the back of the printer, release four M5 screws mounting the short left extrusion.
- ◆ From the front of the printer, release four M5 screws securing the short extrusion.
- ◆ Carefully remove the short extrusion from the frame.

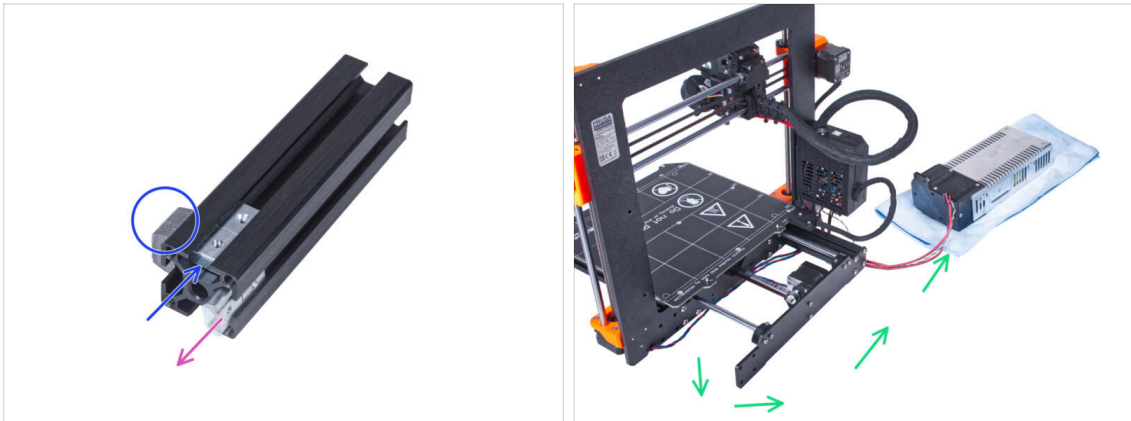
**STEP 9** Repositioning M3nE nuts

- ◆ Remove two M3nE nuts from its original position.
- ◆ Reposition two M3nE nuts to the next "channel" on the left in the extrusion. Notice where the anti-vibration foot is.
- ⓘ The exact position of the nuts in the channel doesn't matter at the moment.
- ◆ Remove the PSU cables from the printer and place the PSU next to the printer.

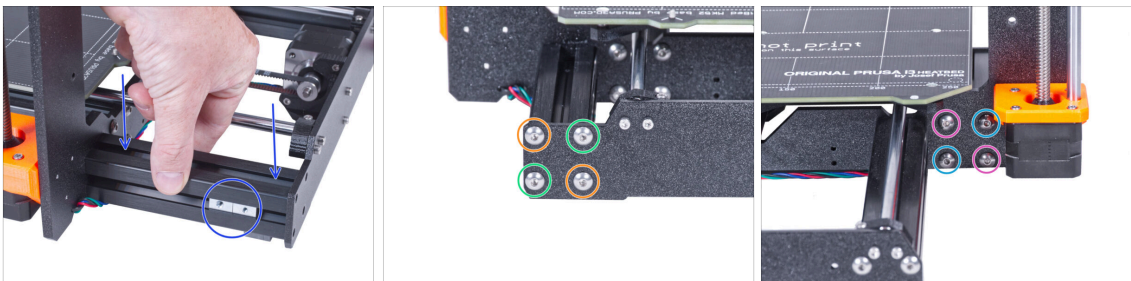
**STEP 10** Attaching the short extrusion

- ◆ Place the short extrusion back to the frame. The M3nE nuts must point out of the printer.
- ◆ From the rear side of the printer, align the holes in the rear plate and the extrusion and secure it with two M5x16r screws diagonally.
- ◆ Insert and tighten two M5x16r into the remaining holes.
- ◆ Secure the extrusion from the front side with two M5x16r diagonally.
- ◆ Insert and tighten two M5x16r into the remaining holes.

## STEP 11 Guiding the cables: parts preparation



◆ For the following steps, please prepare:

- ◆ Zip tie (3x)

## STEP 12 Guiding the cables

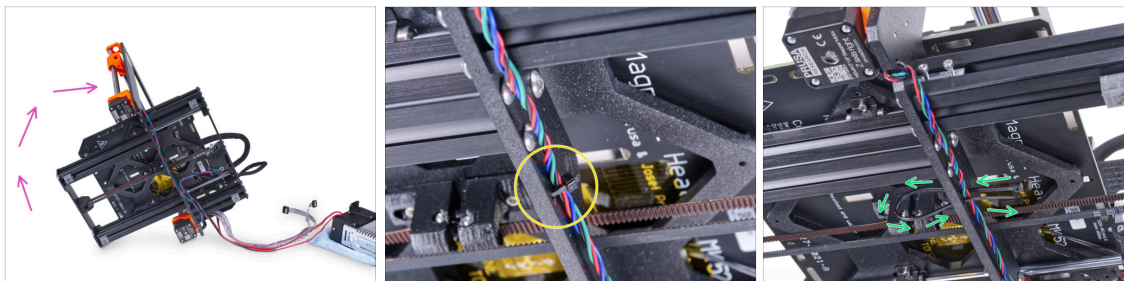

- ◆ Carefully turn the printer on the "electronics" side.
  - ⚠ **Avoid putting the printer on the LCD cables!**
- ◆ Locate the circular holes in the frame near the Z-axis right motor.
  - ⚠ **In the upcoming steps, please tighten all zip ties carefully, as you might pinch/break the cables.**
- ◆ Slide the zip tie through the circular holes in the frame to create a loop.
- ◆ Guide the motor cable in the zip tie and tighten it. Be careful not to over tighten the tie as it can cut the wires. Cut the remaining part.

## STEP 13 Guiding the cables

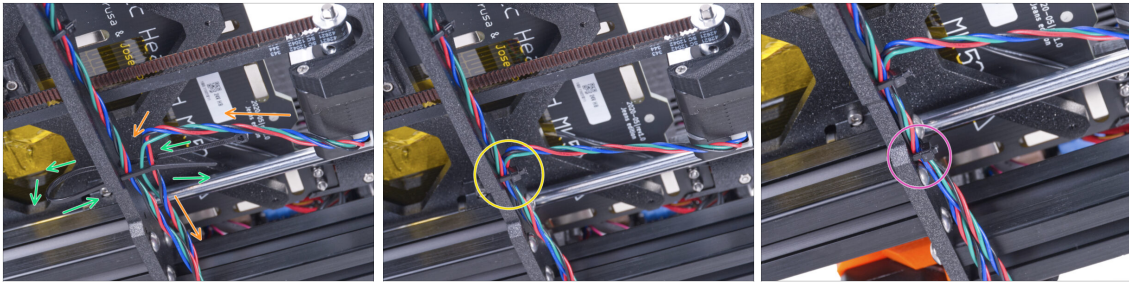

- Continue downwards and using another zip tie create the next loop.
- Insert Y-axis motor cable to the current bundle.
- Push the cable gently in the zip tie and tighten it so it is snug and holding the wires. Be careful not to over tighten the tie as it can cut the wires . Cut the remaining part.
- Following the cables and secure the bundle with the zip tie in the next couple of holes.

## STEP 14 Mounting the printer frame support: part preparation



- **For the following steps, please prepare:**
- Printer frame support (1x)
- M4x10r screw (2x) previously removed from the PSU
- M3x10r screw (2x) previously removed from the PSU

## STEP 15 Mounting the printer frame support

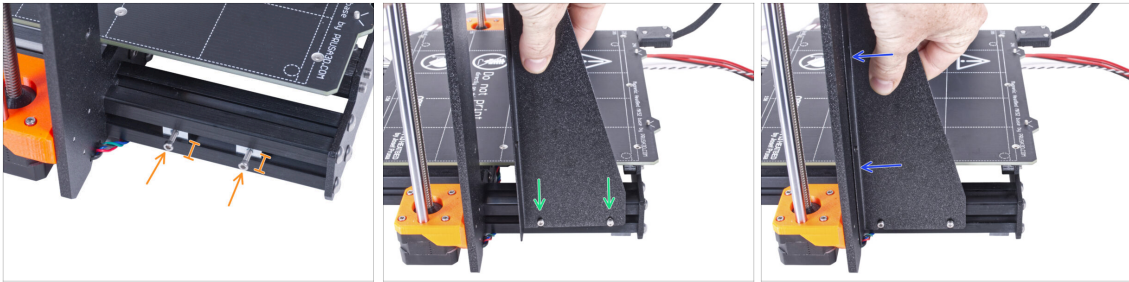

- Insert two M3x10 screws into the M3nE nuts. Do not tighten them completely. Five turns will be enough for now.
- Slide the printer frame support on the screws in the aluminum extrusions (instead of the PSU).
- Move the printer frame support to the frame.

## STEP 16 Mounting the printer frame support

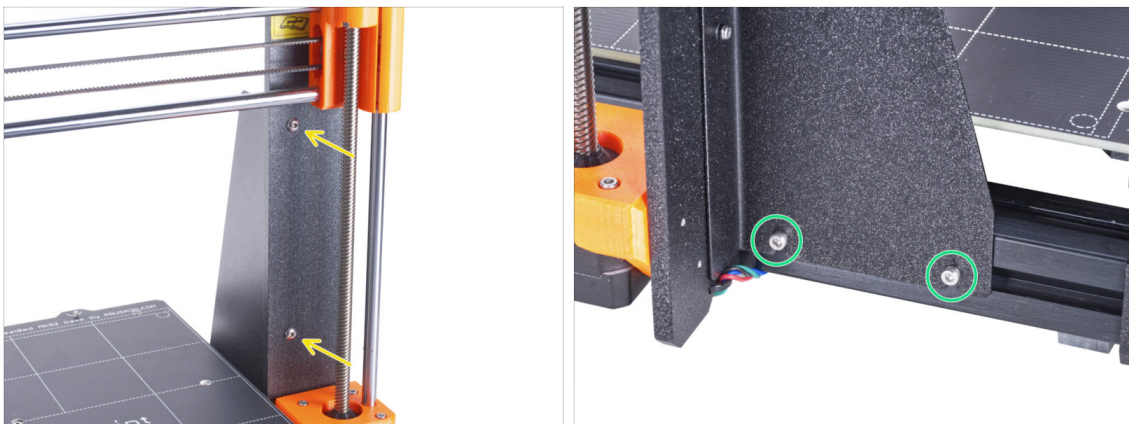

- Secure the printer frame support to the frame with two M4x10r screws.
- Fully tighten the screws on the printer frame support.

## STEP 17 Covering the PSU cables: parts preparation



● For the following steps, please prepare:

⚠ **There are two textile sleeves in your kit with different lengths and diameters.**

- Textile sleeve 8 x 350 mm (1x)
- Zip tie (2x)

## STEP 18 Covering the PSU cables

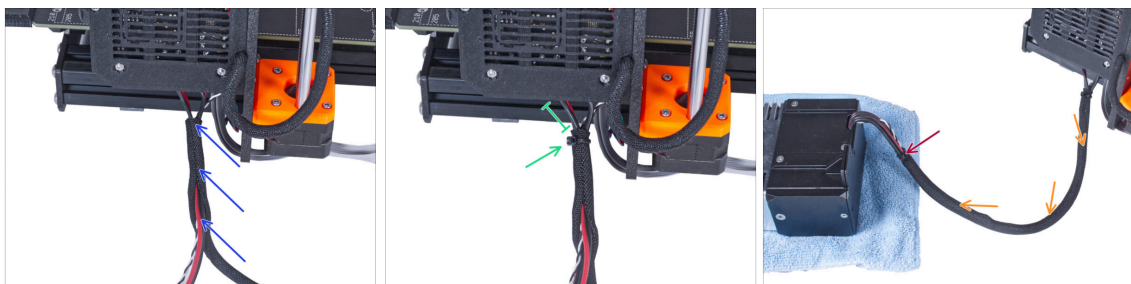

- From the electronics, wrap the PSU cable (including the black&white power panic cable) in the textile sleeve.
- Leave 2-5 cm from the electronics uncovered. Secure the end of the sleeve with the zip tie.
- Wrap the entire length of the bundle and slightly twist the sleeve, **not the cables**.
- Secure the end of the sleeve with the zip tie.

## STEP 19 Covering the LCD cables: parts preparation

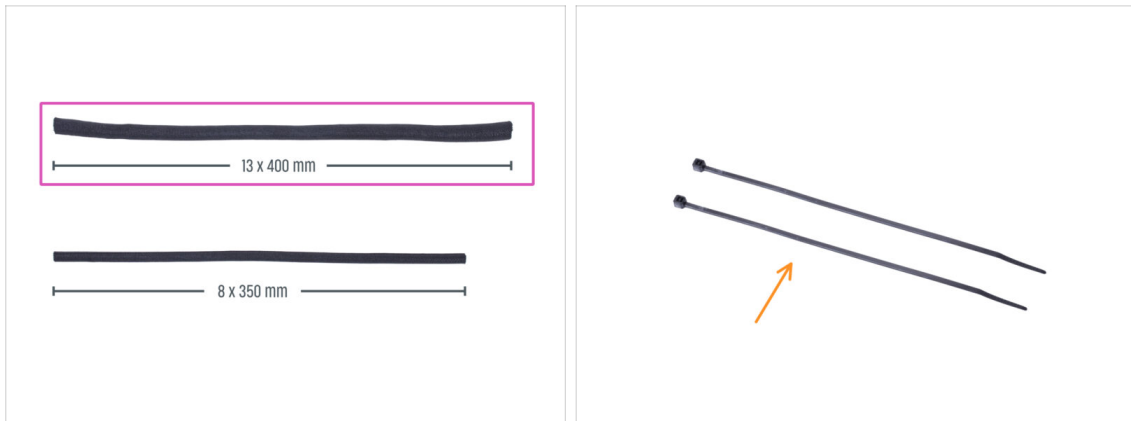

● For the following steps, please prepare:

- Textile sleeve 13 x 400 mm (1x)
- Zip tie (2x)

## STEP 20 Covering the LCD cables

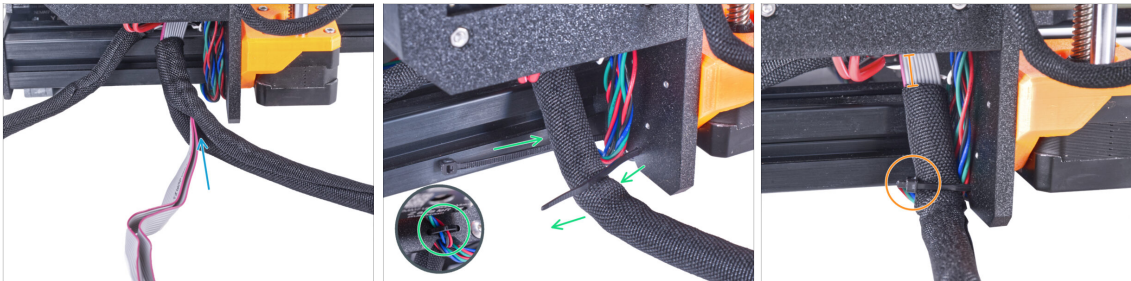

- From the electronics, wrap the LCD cables in the textile sleeve.
- Wrap the entire length of the LCD cable bundle.
- Using the zip tie, create a loop through the circle holes in the frame around the motor cables and LCD cable bundle.
- ⚠ **Do not forget to include the Z-axis left motor cable on the front side of the frame! See the detail.**
- Leave 2-5 cm from the electronics uncovered. Secure the cable bundle with the zip tie. **Do not over tighten the bundle!** You may cut the cables.



## STEP 21 Securing the cables

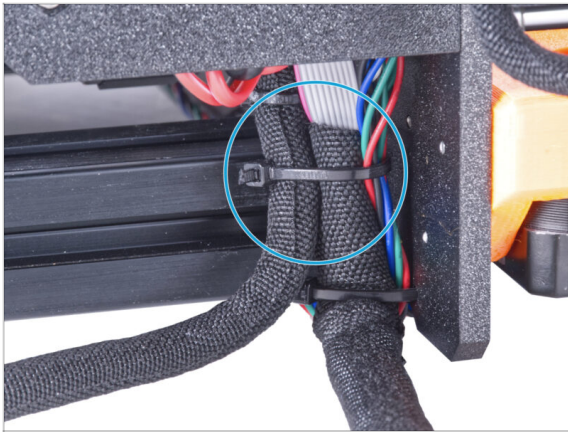

- ◆ Merge the LCD cable bundle and the PSU cable bundle and secure them together with the zip tie.

⚠ **Do not over tighten the zip tie! It can damage the cables.**

## STEP 22 Removing the FS-cover

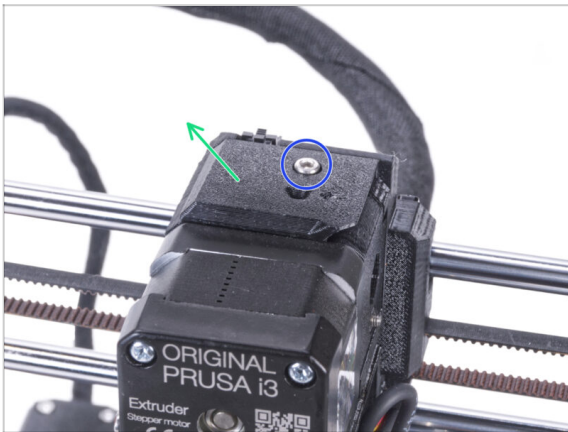

ⓘ The following procedure is intended for a single material printer. If you have a multi material printer, go to [Disassembling the LCD](#).

- ◆ Release the M3x10 screw securing the FS-cover and keep it aside. We will need it again later on.
- ◆ Remove the FS-cover from the extruder.

## STEP 23 Installing the new FS-cover: parts preparation



◆ For the following steps, please prepare:

◆ New FS-cover (1x)

⚠ Note, that the new FS-cover differs from the old one for the MK3S+. It has a brass insert.

◆ M3x10 screw (1x) *re-use the old one*

◆ Fitting QSM-M5 (1x)

## STEP 24 Installing the new FS-cover



◆ Attach the new FS-cover on the extruder. See the correct orientation. The beveled side must be on the right (above the extruder-idler).

◆ Secure it with the M3x10 screw.

◆ Screw the fitting into the brass insert in the FS-cover. No need to use a side wrench.

## STEP 25 Disassembling the LCD

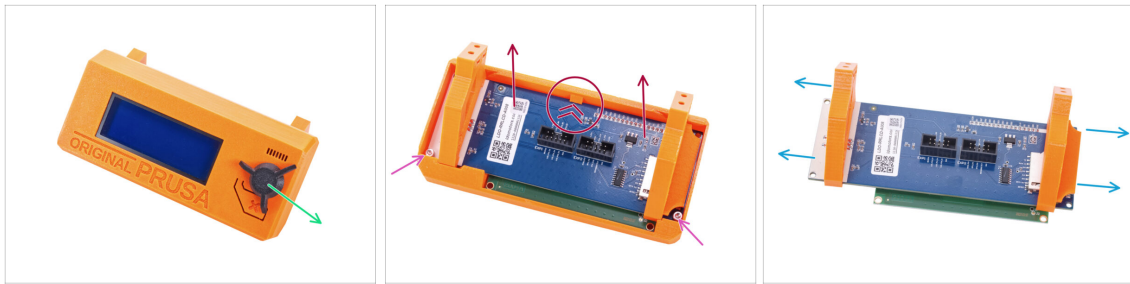

- Remove the SD card from the LCD assembly.
- Remove the LCD knob and keep it for later use.
- Release two M3x10 screws securing the LCD screen.
- Slightly push the latch on the LCD cover and remove the LCD screen.
- Slide off the LCD supports from the LCD screen.

## STEP 26 Preparing the LCD: parts preparation



- **For the following steps, please prepare:**
- LCD-support-L (1x)
- LCD-support-R (1x)
- M3nS nut (2x)
- M3x10 screw (2x) *previously removed*
- LCD-cover (1x) *old part*
- LCD screen (1x) *old part*
- LCD-knob (1x) *old part*

## STEP 27 Preparing the LCD



- Insert all the way the M3nS nut into each LCD-support.
- ⚠ During handling, be careful that the nuts do not fall out of the parts.

## STEP 28 Preparing the LCD

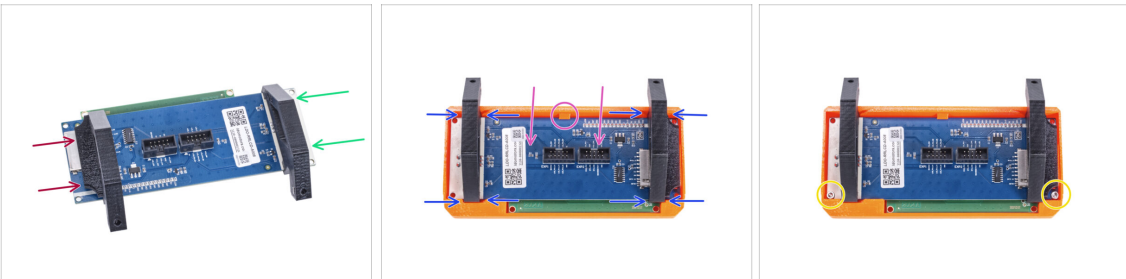

- Slide the LCD-support-L from the left side of the LCD board (side with the SD card slot) to approximately the same position as in the picture.
- Slide the LCD-support-R from the right side to approximately the same position as in the picture.
- Insert the LCD screen with the supports all the way in the LCD-cover. The LCD controller must click under support in the center of the LCD-cover.
- Adjust the position of the supports if needed. It must fit in the cutouts.
- Secure the LCD with two M3x10 screws.

## STEP 29 Assembling the LCD knob



- Attach the LCD-knob on the encoder.
- ⓘ Knob mounting orientation doesn't matter.

## STEP 30 Haribo time!



- That was easy, wasn't it? Reward yourself and replenish your energy for the next chapter.
- Eat the second row of the gummy bears. Leave the others!

## STEP 31 The printer is prepared

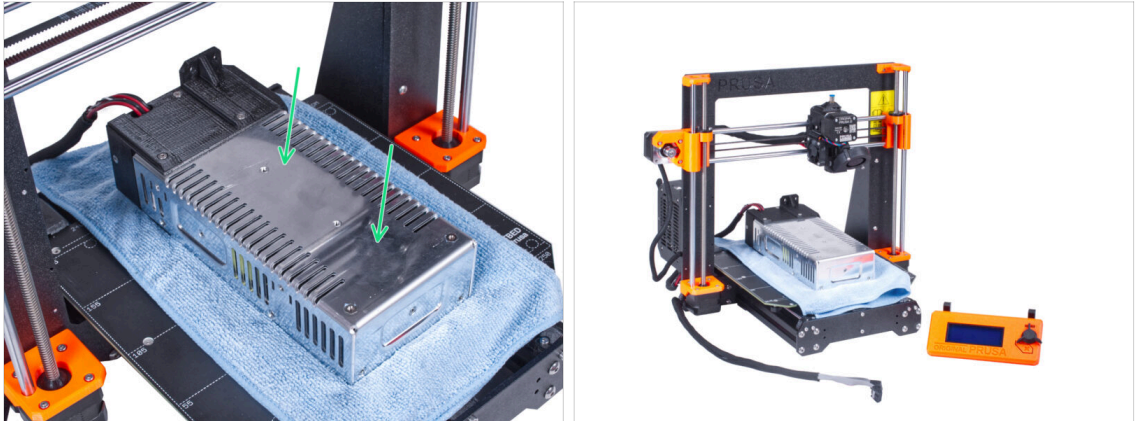

- ◆ Carefully place the PSU on the heatbed. Use a piece of cloth as protection.
- ◆ **Well done, the printer is prepared.**
- ⓘ Place the printer aside for some time, we will need it later on.
- ◆ Now, let's go to the next chapter: **3. Assembling the enclosure**

### 3. Assembling the enclosure

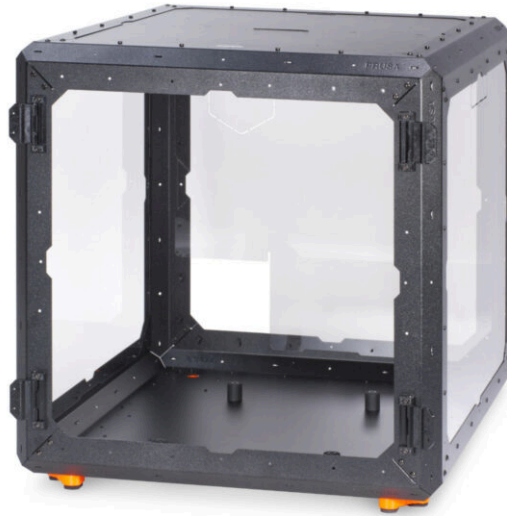

## STEP 1 Tools necessary for this chapter

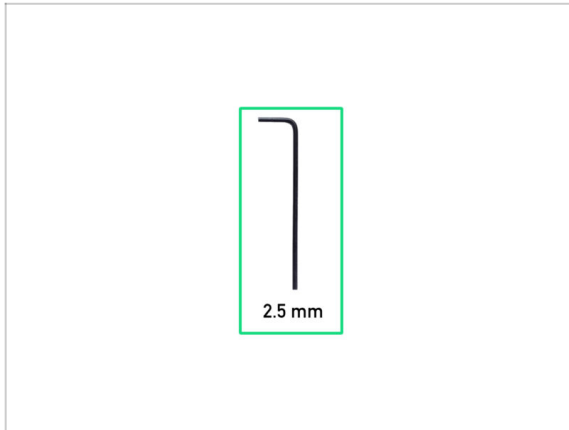

- For this chapter, please prepare:
- 2.5mm Allen key

## STEP 2 LONG vs SHORT profile

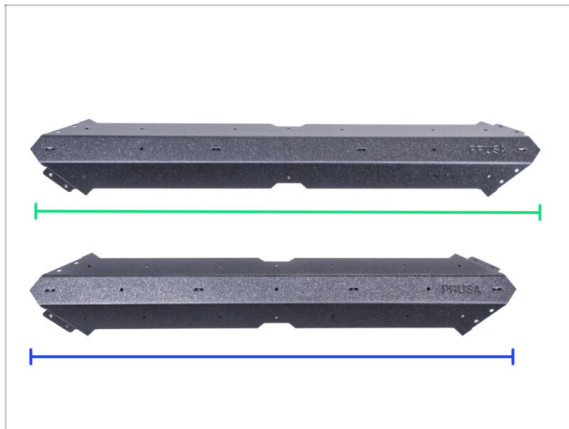

⚠ **NOTE:** There are two types of sheet metal profiles in your kit package. Their only difference is the length. Always compare profiles with each other! See the picture.

- Long profile - 4 pcs in your kit
- Short profile - 8 pcs in your kit
- ⚠ **Handle profiles very carefully! The profiles have sharp edges.**



### STEP 3 Assembling the base frame: parts preparation



● For the following steps, please prepare:

● Long profile (2x)

● Short profile (2x)

⚠ **To be sure, compare the lengths of the profiles.**

● M4x5r screw (8x)

### STEP 4 Assembling the base frame



● Place the profiles on the surface like in the picture:

● Short profile

● Long profile

⚠ **We recommend using a mat under the profiles to protect your work surface from scratches.** After joining them, they will need to be placed with the sharp corners down. You can use the original cardboard box, but don't take it apart, it will come in handy in a little while.

● Pay attention to the correct position of the logo according to the picture.

● Attach both profile to together and align the holes in the joint.

● Join both profiles with two M4x5r screws.

● Use the SAME procedure with another couple of the long and short profile.

## STEP 5 Assembling the base frame

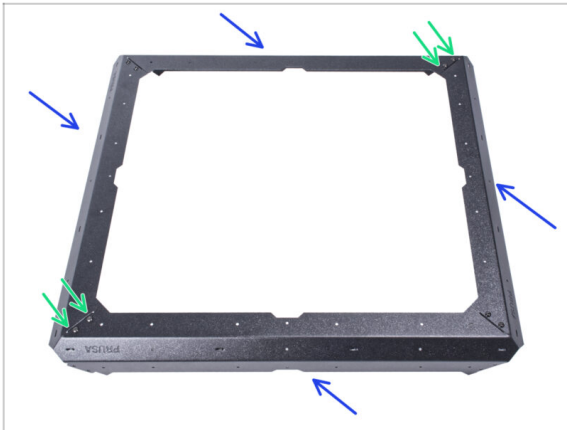

- Attach both assembled base parts together like in the picture.
- Join them together with four M4x5r screws.

## STEP 6 Assembling the feet: parts preparation

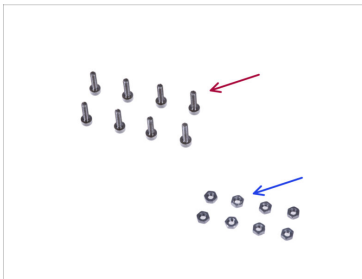
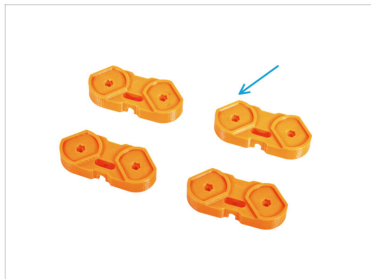

For the following steps, please prepare:

- Feet-bracket (4x)
- M3x12 screw (8x)
- M3n nut (8x)
- Foam block or foam pads set (2x)

## STEP 7 Feet bracket installation

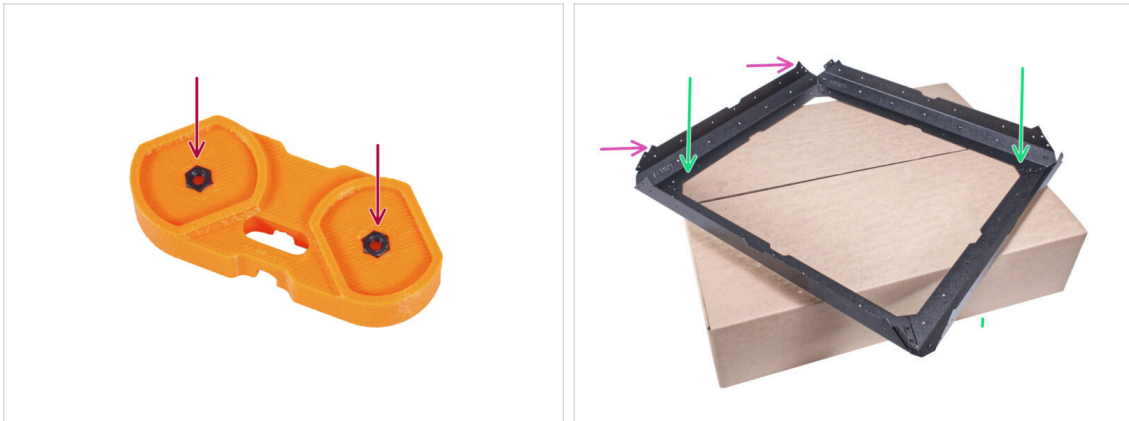

- Insert two M3n nuts into each feet-bracket.
- Place the base assembly on top of the original cardboard box (Profiles & Steel sheets), with at least one corner extending over the box.
- See the correct orientation of the base. The metal sheet “thorns” must facing up.
- ⓘ If you cannot use a cardboard box, place the assembly on the edge of the surface. Don't forget to use a pad to protect the surface from scratches.

## STEP 8 Assembling the feet



- Take the feet-bracket and orient it to the extending corner, as in the picture. **See the orientation of the part.**
- In this orientation, **place the feet-bracket under the joint of the profiles** and align the holes of the parts.
- Secure all parts with two M3x12 screws.
- Proceed the same with the remaining feet-brackets.
- Turn the frame so that the feet-brackets are facing up.

## STEP 9 Attaching the anti-vibration pads

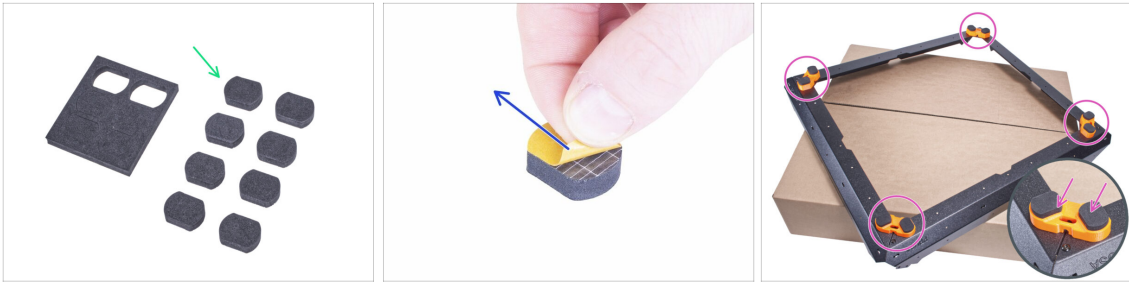

- ◆ Gently push 8 pads out of the blocks.
- ⓘ Keep the remaining four pads as a spare.
- ◆ Peel the protective film from all pads. Be careful, there is glue (adhesive) applied on the pad.
- ◆ Glue two anti-vibration pads into each foot-bracket.
- ◆ Turn the frame on its feet and place it aside for a while.

## STEP 10 Assembling the bottom panel: parts preparation



- ◆ **For the following steps, please prepare:**
- ◆ Bottom panel (1x)
- ◆ M3x4 screw (16x)
- ◆ Paper box (1x) at least 15 x 15 x 8 cm. We will use it as another temporary pad.
- ⓘ You can use any of the Prusament spool.

## STEP 11 Assembling the bottom panel

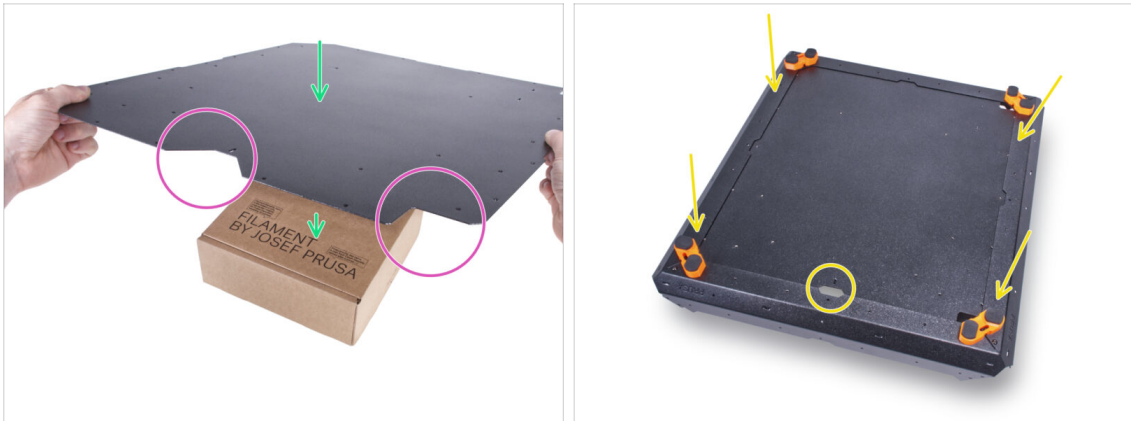

- Place the bottom panel on the cardboard box. Place the box so that it is in the center of the panel.
- ⚠️ Correct panel and frame orientation is crucial! Follow the correct procedure and look carefully at the orientation of the parts in the pictures.**
- Note the "V" cutout in the front and the "L" cutout on the right. Maintain this orientation of the bottom panel.
- Take the base frame assembly and place it on the bottom panel. The "V" cutout in the panel must be facing against the cutout on the base frame.

## STEP 12 Securing the bottom panel



- Secure the bottom panel near front and rear corner by two M3x4 screws.
- Insert the remaining fourteen M3x4 screws into the other holes.
- ⚠️ The four holes marked "X" in the picture must remain empty.**

### STEP 13 Installing the anti-slip dampers: parts preparation

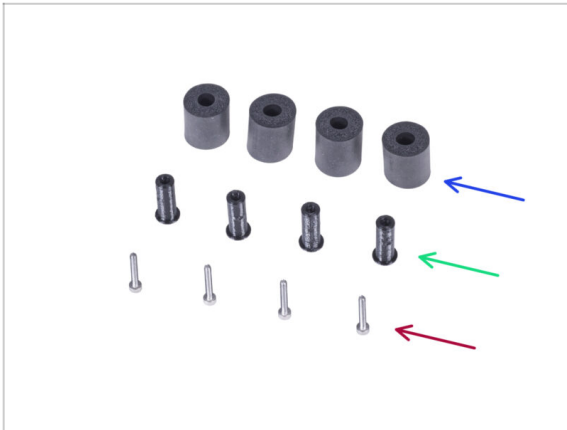

◆ For the following steps, please prepare:

- ◆ Anti-slip damper (4x)
- ◆ Damper-insert (4x)
- ◆ M3x20 screw (4x)

### STEP 14 Preparing the anti-slip dampers



- ◆ Push the damper-insert into the anti-slip damper. No matter which side, the anti-slip damper is symmetrical.
- ◆ Turn the assembly on its feet and orient the base with the front center cutout facing to the front.
  - ⓘ Remember that this cutout will mark the front of the enclosure during assembly.
- ◆ Locate the two threaded holes in the front and two in the back on the bottom panel. We will use them in the next step.
  - ⚠ Avoid using the holes marked "X" in the picture.

## STEP 15 Mounting the anti-slip dampers

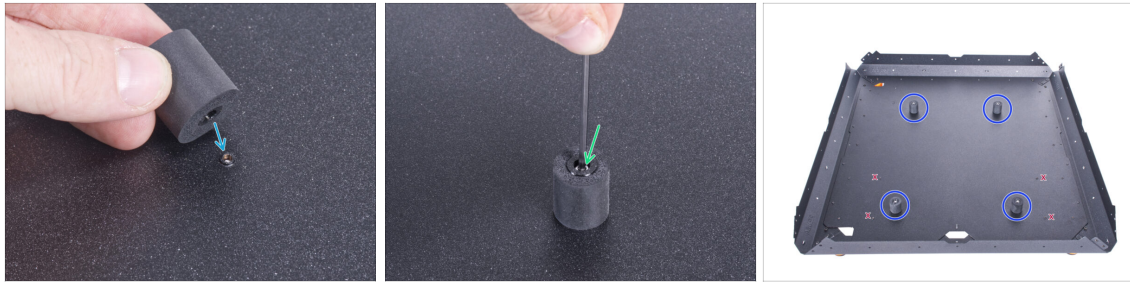

- Place the anti-slip damper on the threaded hole.
- Insert the M3x20 screw into the anti-slip damper and tighten it.
- Proceed the same for other anti-slip dampers.

**⚠ To be sure, check if you are using the correct holes!**

## STEP 16 Assembling the supports: parts preparation



**⬛ For the following steps, please prepare:**

- Short profile (4x)

**⚠ To be sure, compare the lengths of the profiles.**

- M4x5r screw (16x)

## STEP 17 Assembling the supports

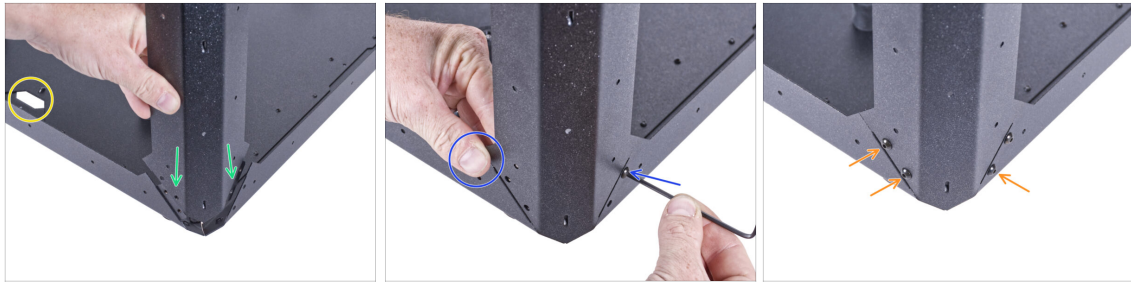

- ◆ Orient the assembly like in the picture, see the front cutout.
- ⚠ **BE VERY CAREFUL! Profiles have sharp edges. A falling profile can cause you injury or damage the work surface.**
- ◆ Attach the short profile to the right corner. **Make sure, there is no PRUSA logo on the lower side of the profile.**
- ⓘ Take a closer look at the joint - one side overlaps the bottom profile and the other is overlapped by another bottom profile.
- ◆ Hold the profile with your hand to maintain the position and secure it with one M4x5r screw.
- ◆ Insert and tighten remaining three M4x5r screws.

## STEP 18 Assembling the supports



- ◆ Check that all profiles have the PRUSA logo at the top.
- ◆ Attach the other three profiles in the same way.



## STEP 19 Assembling the top frame: parts preparation

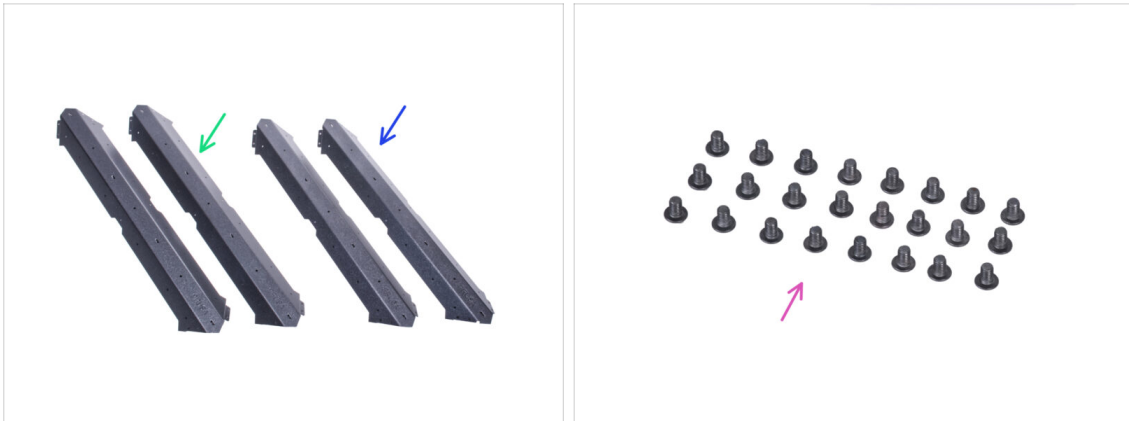

● For the following steps, please prepare:

● Long profile (2x)

● Short profile (2x)

⚠ **To be sure, compare the lengths of the profiles.**

● M4x5r screw (24x)

## STEP 20 Assembling the top frame



● Orient the assembly with the front side facing you.

⚠ **BE VERY CAREFUL! Profiles have sharp edges. A falling profile can cause you injury or damage the work surface.**

● Attach the short profile on the supports and secure it with two M4x5r on each end.

● **From now, the PRUSA logo must be on the right side on every top profile.**

● From the right side of the assembly, attach the long profile on the supports and secure them with two M4x5r screws on each end. Maintain the PRUSA logo position.

● Secure the joint of both top profiles with two M4x5r screws.

## STEP 21 Assembling the top frame

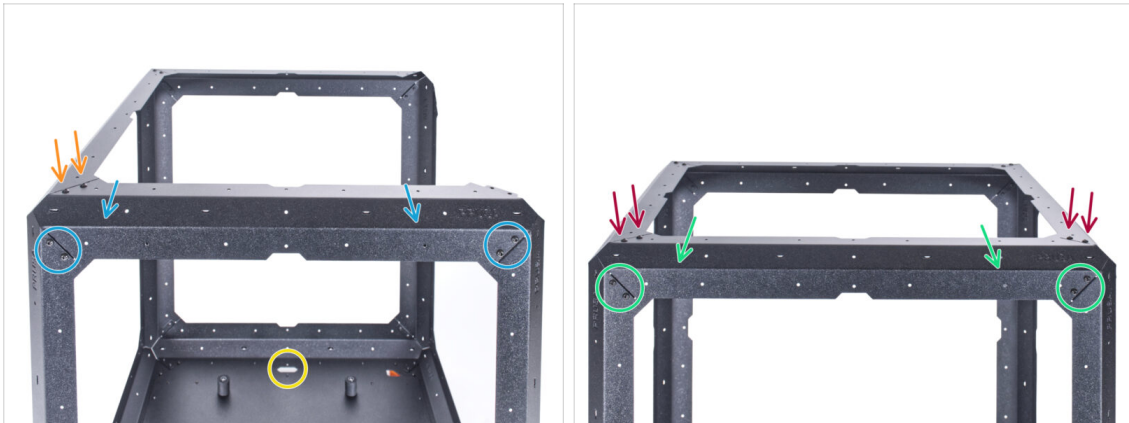

- Turn the assembly with the rear side facing you, see the front cutout.
- ⚠ **BE VERY CAREFUL! Profiles have sharp edges. A falling profile can cause you injury or damage the work surface.**
- From the rear side, attach the short profile on the supports and secure them with two M4x5r screws on each end. Maintain the PRUSA logo position.
- Secure the joint of the profiles from the top with two M4x5r screws.
- Attach the remaining long profile on the supports and secure it with two M4x5r screws on each end. Maintain the PRUSA logo position.
- Secure each joint of the profile from the top with two M4x5r screws.

## STEP 22 Assembling the top panel: parts preparation



- **For the following steps, please prepare:**
- Top panel (1x)
- M3x4 screw (16x)

## STEP 23 Preparing the top panel



**⚠** For the next step, it is essential to insert the top panel inside the enclosure in the correct orientation. Pay close attention to the pictures and instructions:

- ◆ There are perforations on one side of the top panel - during assembly, **perforations must be facing down** (they work as zip tie holders).
- ◆ The **top panel is not symmetrical** - notice the two holes - when mounting the holes must be on the back of the enclosure.
- ◆ Grasp the top panel with the **perforations pointing down and the marked holes on the back of the panel**.
- ◆ Maintain this position for the next step.

## STEP 24 Assembling the top panel



- ◆ From the front side, insert the top panel **INSIDE** the enclosure. Mind the correct orientation. See the cutouts on the panel.
- ◆ The **perforations on the panel must be facing down** (inside the enclosure).
- ◆ Lift the top panel all the way up and attach it to the top frame. Align the holes and secure the panel with three M3x4 screws.
- ◆ Insert the remaining M3x4 screws and completely tighten all 16 screws.
- ⚠** There are holes marked "X" in the picture, leave them empty.

## STEP 25 Installing the PSU-locks: parts preparation

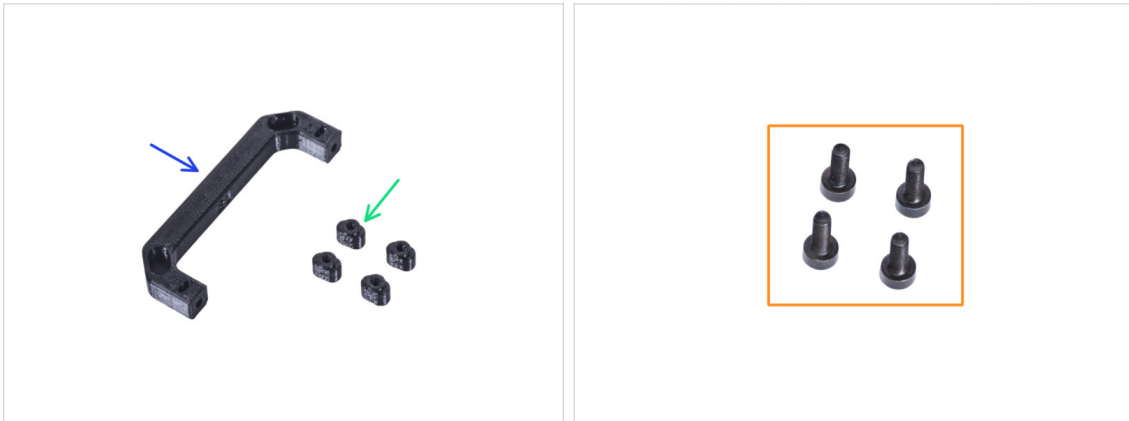

● For the following steps, please prepare:

- PSU-handle (1x)
- PSU-lock (4x)
- M3x8 screws (4x)

## STEP 26 Installing the PSU-locks



- Position the enclosure as shown in the picture. The front side (the side with the cutout in the bottom panel) should be on the **left**.
- Focus on the **right side** — the far corner from your position.
- From the outside, insert the M3x8 screw into the marked opening on the bottom frame profile.
- **i** We will use the PSU-handle as a tool to attach the PSU-locks in the following steps.
- Insert one PSU-lock into the pocket in the PSU-handle.

## STEP 27 Mounting the PSU-locks

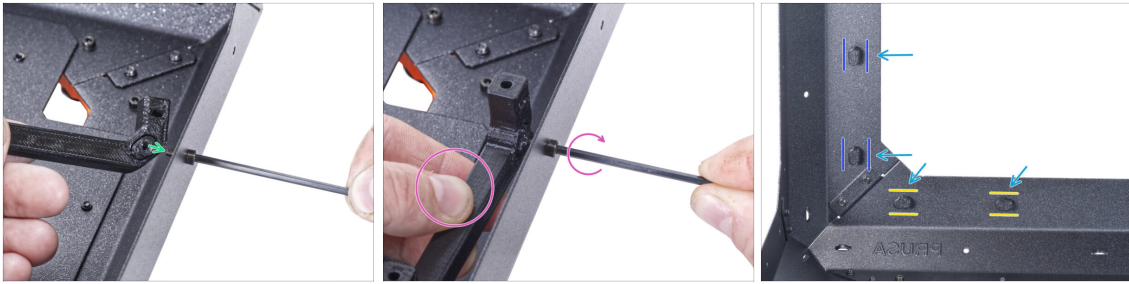

- ◆ Take the PSU-handle with the inserted PSU-lock and attach it on the M3x8 screw from the inside.
- ◆ Hold the PSU-handle and tighten the M3x8 screw in the same time. **Do not overtighten the screw! The PSU-lock must move freely.**
- ◆ Use the same procedure for the remaining PSU-locks. See their positions from inside the enclosure:
  - ◆ On the bottom frame, turn the PSU-locks to the horizontal position.
  - ◆ On the support, turn the PSU-lock to the vertical position.
- ◆ Do not leave the PSU-handle mounted on the PSU-lock. Take it off, we will need it in the next chapter.

## STEP 28 Assembling the hinges: parts preparation

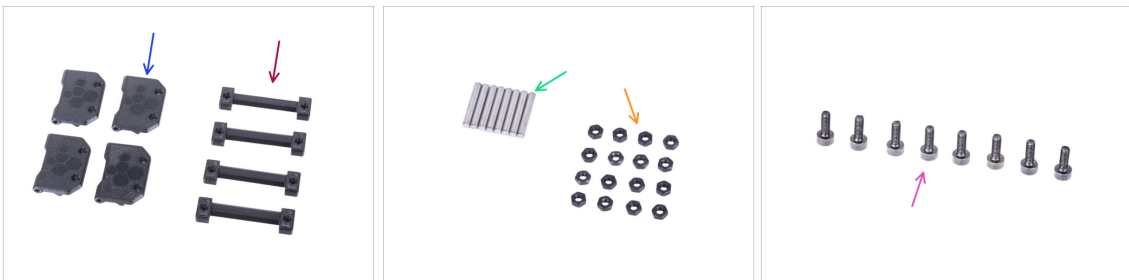

- ◆ **For the following steps, please prepare:**
  - ◆ Door-hinge (4x)
  - ◆ Enclosure hinge (4x)
  - ◆ Pin 3x20 (8x)
  - ◆ M3n nut (16x)
  - ◆ M3x8 screw (8x)

## STEP 29 Assembling the hinges



- Place the enclosure hinge into the door hinge. See the correct orientation of both parts.
- ⚠ **Look carefully at the orientation of both parts. Their reverse disassembly is impossible.**
- Insert the pin from both side of the hinge.
- Push two pins all the way into the hinge against a hard surface (e.g. workshop table). The end of the pin must be aligned with the surface of the printed part.
- Insert four M3n nuts into each hinge assembly.

## STEP 30 Mounting the hinges



- Turn the enclosure with the front side facing to you.
- Locate two holes on the top of the left support.
- From inside, insert two M3x8 screws.
- Attach the hinge on the screws and tighten it. **Mind the correct orientation of the hinge.**

### STEP 31 Mounting the hinges

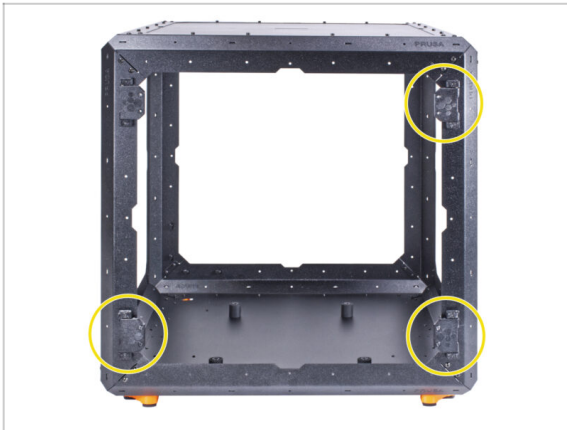

- Use the same procedure for the remaining three hinges.
- ⚠ Mind the correct orientation of the hinges.**

### STEP 32 Assembling the back panel: parts preparation



- For the following steps, please prepare:
- Back panel (1x)
- ⚠ Do not remove the protective foils from the panel at this time!**
- Nylon rivet (14x)

### STEP 33 Assembling the back panel



- ◆ Turn the Enclosure so that the rear side is facing towards you.
- ◆ There are protective foils on both sides of the panel. Peel off both foils.
  - ⚠ **Handle the panel with care. It can be scratched easily.**
- ◆ Insert the back panel into the enclosure and attach it to the rear frame from inside. Notice how the panel is oriented. Use cutouts for better understanding.
- ⚠ **Do not wipe the panel with a paper towel. Use microfiber material.**

### STEP 34 Assembling the back panel



- ◆ Near the center of the top profile, align the hole in the back panel and the hole in the top profile. Insert the nylon rivet in the hole.
  - ⚠ **Do not use the holes marked "X" in the picture!**
- ◆ Push on the nylon rivet to secure the back panel in the frame.
- ◆ Proceed the same with remaining 13 nylon rivets. **Note carefully which holes to use.**



## STEP 35 Assembling the side panel (right): parts preparation



● For the following steps, please prepare:

● Side panel (1x)

⚠ **Do not remove the protective foils from the panel at this time!**

ⓘ There are two identical side panels in your package. It doesn't matter which one you choose now.

● Nylon rivet (16x)

## STEP 36 Assembling the side panel (right):

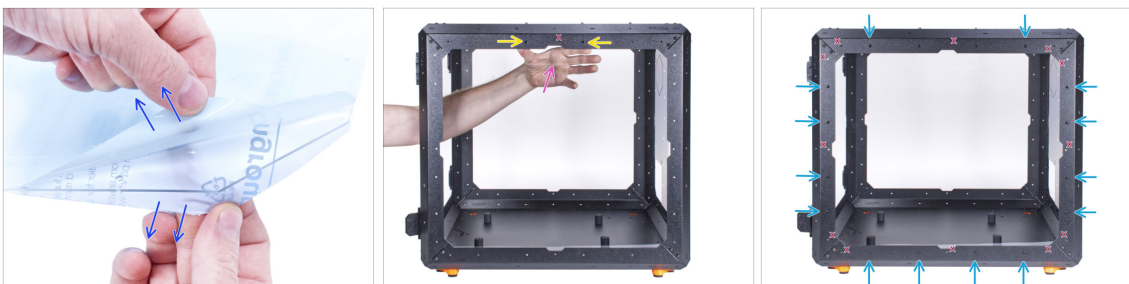

● There are protective foils on both sides of the panel. Peel off both foils.

● Attach the side panel on the right side of the Enclosure from inside. The side panel is symmetrical, it doesn't matter which side you attach to the frame. **It is important that the cutout for the transport handle is at the top.**

● Secure it with two nylon rivets in the top profile.

⚠ **Do not use the holes marked "X" in the picture!**

● Secure the side panel with remaining 14 nylon rivets. **Note carefully which holes to use.**

⚠ **Do not wipe the panel with a paper towel. Use microfiber material.**

## STEP 37 Assembling the side panel (left): parts preparation



● For the following steps, please prepare:

● Side panel (1x)

⚠ **Do not remove the protective foils from the panel at this time!**

● Nylon rivet (16x)

## STEP 38 Assembling the side panel (left)

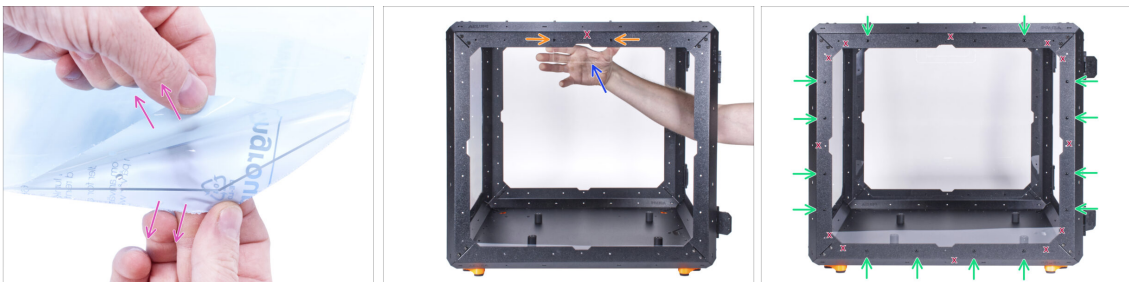

● There are protective foils on both sides of the panel. Peel off both foils.

● Attach the side panel on the left side of the Enclosure from inside. The side panel is symmetrical, it doesn't matter which side you attach to the frame. **It is important that the cutout for the transport handle is at the top.**

● Secure it with two nylon rivets in the top profile.

⚠ **Do not use the holes marked "X" in the picture!**

● Secure the side panel with remaining 14 nylon rivets. **Note carefully which holes to use.**

⚠ **Do not wipe the panel with a paper towel. Use microfiber material.**

### STEP 39 Haribo time!

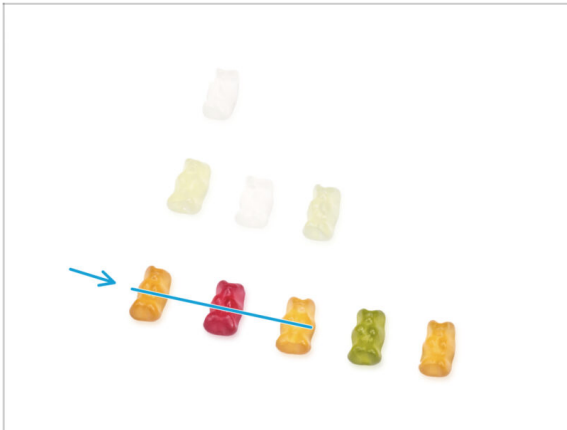

- ◆ You have successfully assembled the base of the enclosure. This requires a certain reward!
- ◆ Eat three gummy bears from the third row. Leave the others!

---

### STEP 40 Well done!

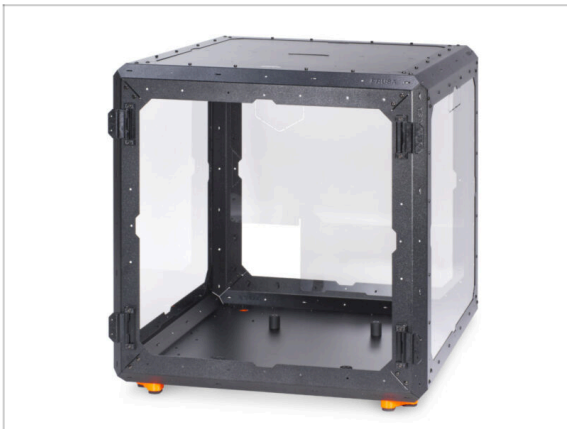

- ◆ **Good job!** You have successfully assembled the base of the enclosure.
- ◆ Compare your assembly with the picture.

---

### STEP 41 PSU variant for MK3S+

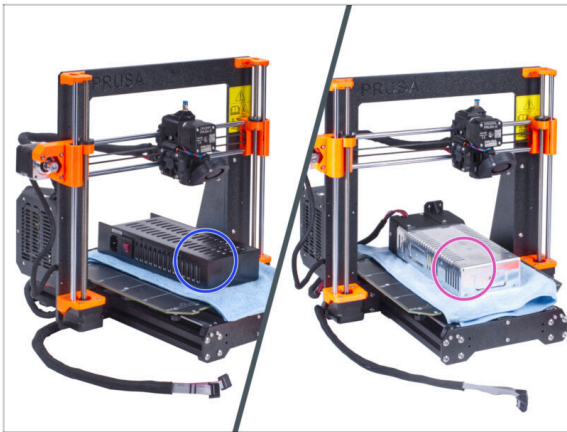

- Now follow the chapter depending on which PSU variant you have on your printer:
  - Black PSU:** go to the next chapter [4A. Installing the printer \(MK3S+ Black PSU\)](#)
  - Silver PSU:** go to the next chapter [4B. Installing the printer \(MK3S+ Silver PSU\)](#)

---

### STEP 42 Enclosure + MK4/MK3.9



- Now follow the chapter [4C. Installing the printer \(MK4/MK3.9\)](#)



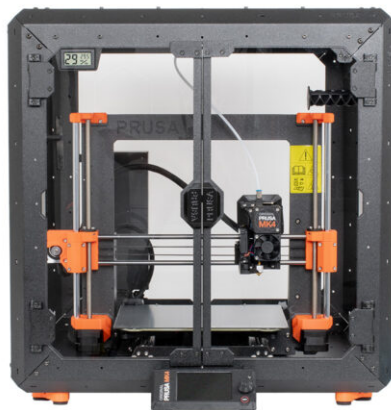

## 4A. Installing the printer (MK4/S & 3.9/S)

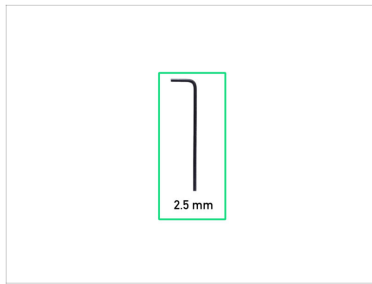

## STEP 1 Tools necessary for this chapter





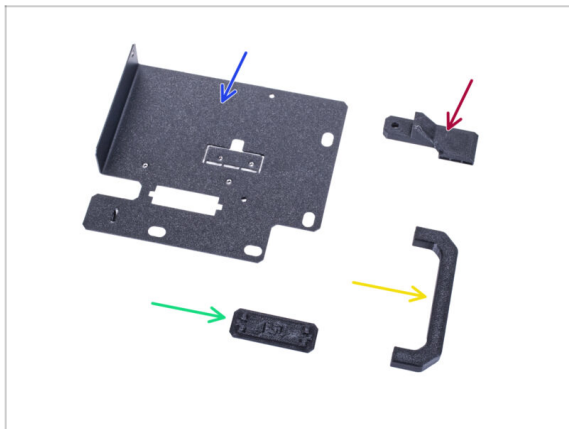

### For this chapter, please prepare:

-  2.5mm Allen key
-  Needle-nose pliers
-  Phillips screwdriver PH2
-  Pocket knife or snap-off knife

## STEP 2 Assembling the PSU holder: parts preparation



### For the following steps, please prepare:

-  PSU holder (1x)
  -  PSU-handle (1x)
  -  PSU-retainer (1x)
  -  PSU-holder-plug (1x)
-  The list continues in the next step...

### STEP 3 Assembling the PSU holder: parts preparation



● For the following steps, please prepare:

- M3x12 screw (4x)
- Standoff (2x)
- M3nS nut (2x)
- 6/32" screw (1x)
- M4x5r screw (1x)
- Magnet 20x6x2 (3x)

### STEP 4 Assembling the PSU holder

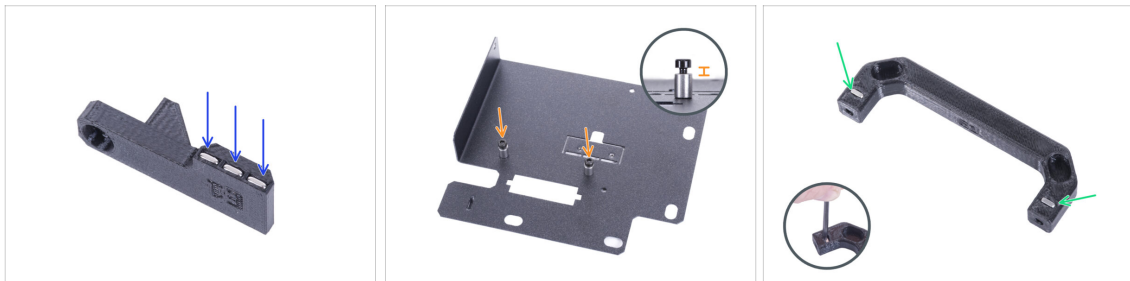

- Push three magnets into the PSU-retainer.
- Screw two M3x12 screws with two standoffs into the PSU-holder. **Do not tighten the screw completely!** There must be 2-3 mm space between the screw head and the standoff.
- Insert two M3nS nuts into the PSU-handle. Use the 2.5 mm Allen key to completely push the nuts inside.

## STEP 5 Assembling the PSU holder



- Push two M3x12 screws through the holes in the PSU holder.
- Align the PSU-handle with the screws. Maintain the same orientation of the PSU-handle, like in the picture - see the pockets.
- Join the handle with PSU holder by tightening both M3x12 screws.

## STEP 6 Assembling the PSU holder

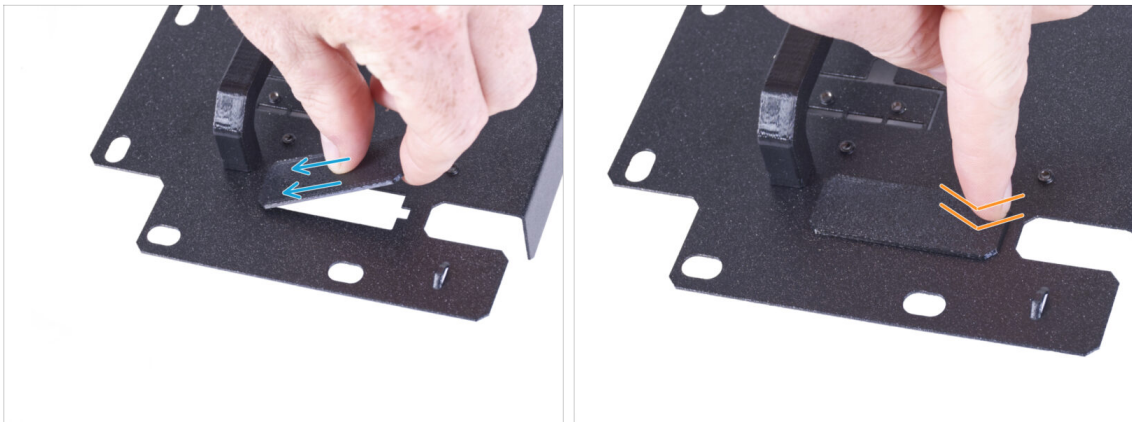

- ⓘ If you have purchased the Quick release cable add-on, you do not need to install this cover.
- Slide one end of the PSU holder cover into the opening in the PSU holder.
- Push on the other end into the opening. You should feel slightly "click" to ensure the part fits properly.



## STEP 7 Assembling the PSU holder



- 🟠 Prepare the printer with the PSU. Place the PSU on the cloth.
- 🟡 Align the open grooves in the PSU against the screws on the PSU holder.
- 🟢 Slide the PSU on these screws and tighten the screws using a 2.5mm Allen key.

## STEP 8 Assembling the PSU holder



- 🟢 On the PSU side, align the hole in the PSU holder with the hole in the PSU.
- 🟡 Secure both parts with the M4x5r screw.
- 🟠 Using the 6/32" screw, attach the PSU-retainer to the corner of the PSU as shown in the picture. Note the correct orientation of the parts.

## STEP 9 Covering the PSU: parts preparation



● For the following steps, please prepare:

- PSU-cover (1x) *re-use the old part*
- M3x10 screw (2x) *re-use the old part*
- Zip tie (1x)

## STEP 10 Covering the PSU

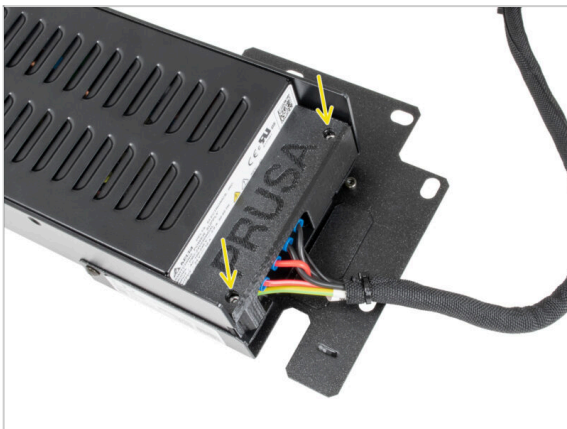

- Mount the PSU cover back on the PSU using two M3x10 screws.

## STEP 11 Guiding the PSU cable bundle

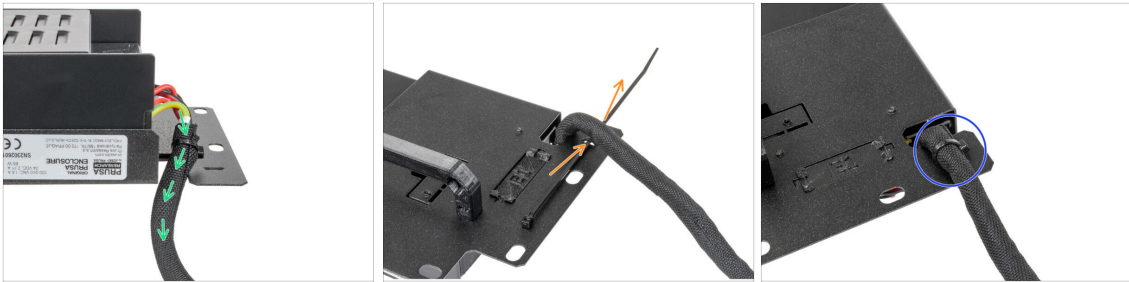

- Guide the PSU cable bundle through the opening in the PSU holder.
- From the rear side of the PSU holder, push the zip tie through the perforation on the holder.
- Tighten the zip tie around the PSU cable bundle.
- Carefully put the printer with the PSU aside for now. We will come back to it in a while.

## STEP 12 Installing the printer

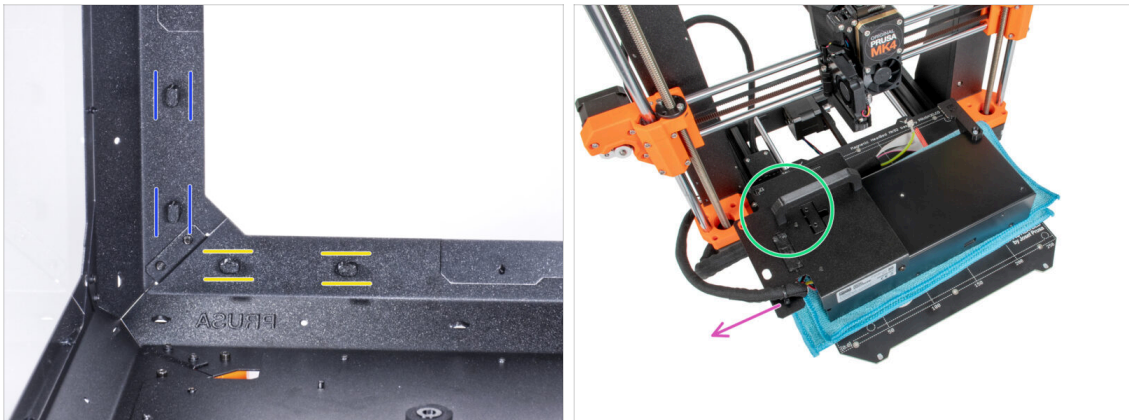

- Ensure the PSU-locks are still turned at the same position:
  - **On the bottom frame**, turn the PSU-locks to the horizontal position.
  - **On the support**, turn the PSU-lock to the vertical position.
- Place the PSU on the heatbed protected with the cloth.
- Turn it with the PSU-handle facing upwards.
- The PSU cable bundle must guide to the left.

## STEP 13 Installing the printer



- ◆ To get the printer into the enclosure, insert its left side first.
- ⚠ **Avoid scratching the side panels with the printer!**
- ◆ Place the printer at an angle (as shown in the picture) in the enclosure behind the anti-slip dampers.
- ⓘ It's just a temporary position for the printer. We will adjust the correct position later.

## STEP 14 Installing the PSU



- ⓘ It is more convenient to use the right hand.
- ◆ Insert the PSU through the hole at the bottom of the back panel. Start by pushing through the part with the PSU-retainer (the part with the magnets).

## STEP 15 Installing the PSU

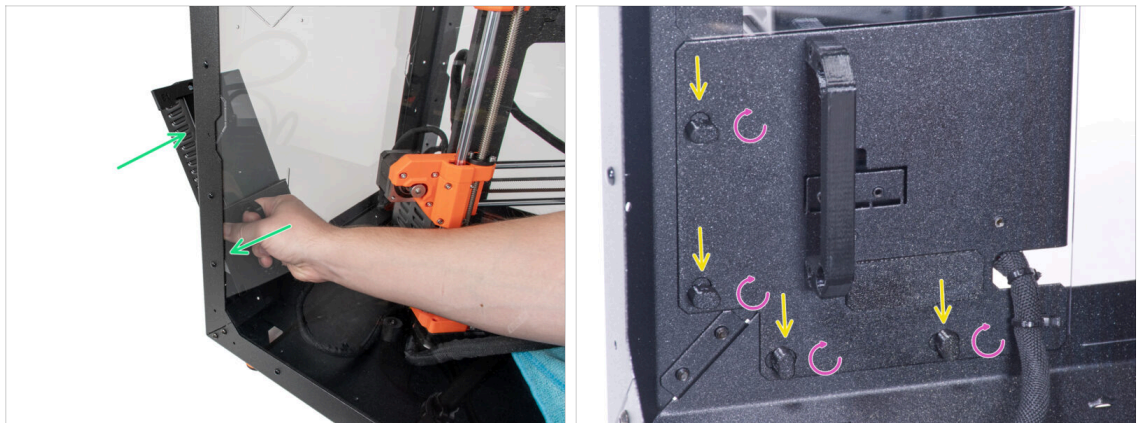

- Tilt the PSU towards the back panel. The PSU must be outside the enclosure and the PSU holder inside the enclosure.
- **The PSU holder must fit perfectly on all four PSU-locks.**
- Turn all PSU-lock 90° to lock the PSU assembly.

## STEP 16 Adjusting the printer

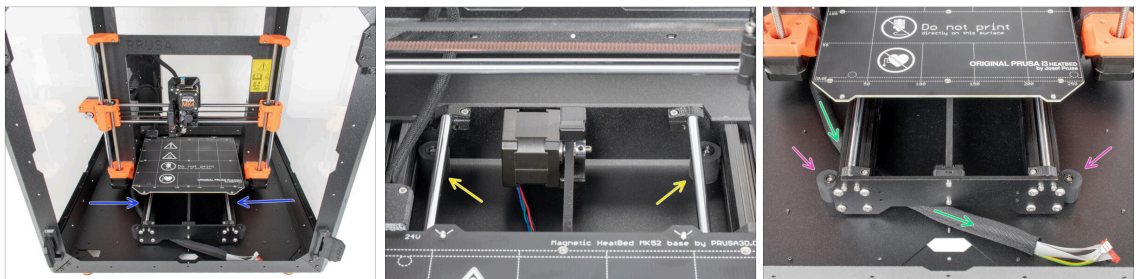

- Rearrange position of the printer like in the picture. Place it in the center of the enclosure and adjust the correct position:
- The two rear anti-slip dampers must be locked against the rear plate from the inside.
- The two front anti-slip dampers must be locked from the outside by the front plate.
- Guide the xLCD cable bundle under the printer from the electronics to the front side of the enclosure. Leave the cable free for now.

## STEP 17 Mounting the xLCD: parts preparation



### For the following steps, please prepare:

For MK4S/3.9S users:

MK4S xLCD assembly (1x)

**i** Now continue to the step **Version B: Mounting the xLCD**. The process is the same as the Version B mounting.

For MK4/3.9 users:

xLCD assembly (1x)

M3x8 screw (2x)

Zip tie (2x)

## STEP 18 Version A: Mounting the xLCD

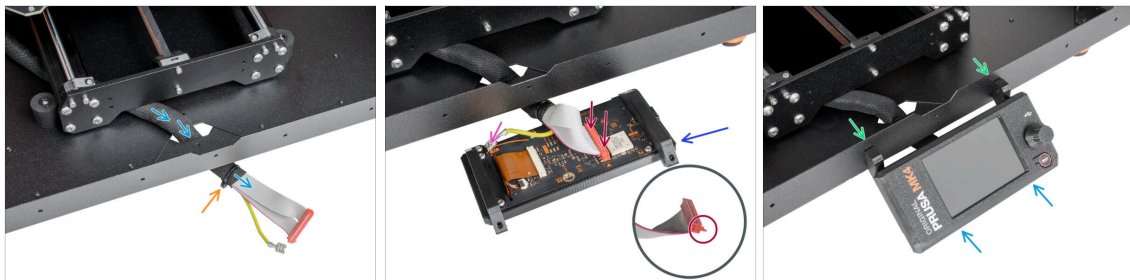

- Guide the xLCD cable through the cutout in the bottom panel.
- Secure the textile sleeve on the cable bundle with the zip tie. **Do not over tighten the zip tie**, it may cut the cables!
- Place the xLCD assembly close to the xLCD cables, like in the picture. Mind the same orientation of the xLCD as in the picture. See the xLCD-supports for better understanding.
  - Connect the xLCD cable to the xLCD board. Note the safety latch on the xLCD cable connector. It must be plugged into the side of the xLCD slot marked with the orange triangle on the board.
  - Take the end of the PE cable with square connector. Slide the connector onto the PE Faston all the way down.
- From the inside, push two M3x8 screws through the bottom profile.
- Slide the xLCD assembly onto the two M3x8 screws in the frame and tighten them.

## STEP 19 Version B: Mounting the xLCD

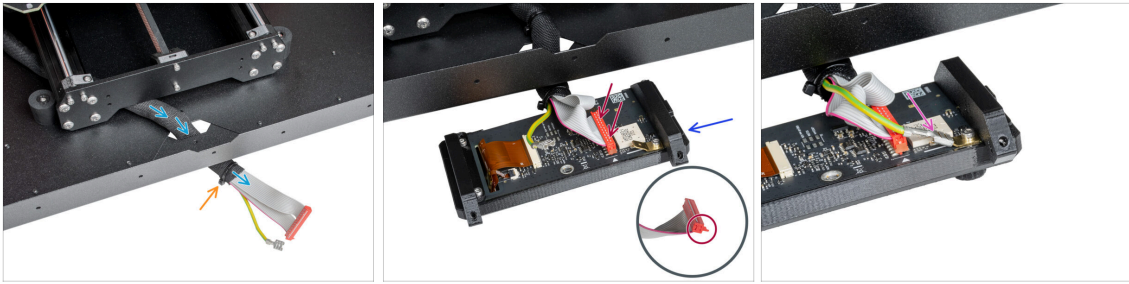

- ◆ Guide the xLCD cable through the cutout in the bottom panel.
- ◆ Secure the textile sleeve on the cable bundle with the zip tie. **Do not over tighten the zip tie**, it may cut the cables!
- ◆ Place the xLCD assembly close to the xLCD cables, like in the picture. Mind the same orientation of the xLCD as in the picture. See the xLCD-supports for better understanding.
  - ◆ Connect the xLCD cable to the xLCD board. Note the safety latch on the xLCD cable connector. It must be plugged into the side of the xLCD slot marked with the orange triangle on the board.
  - ◆ Take the end of the PE cable with square connector. Slide the connector onto the PE Faston all the way down.

## STEP 20 Version B: Mounting the xLCD



- ◆ From the inside, push two M3x8 screws through the bottom profile.
- ◆ Slide the xLCD assembly onto the two M3x8 screws in the frame and tighten them.

## STEP 21 Securing the xLCD cable

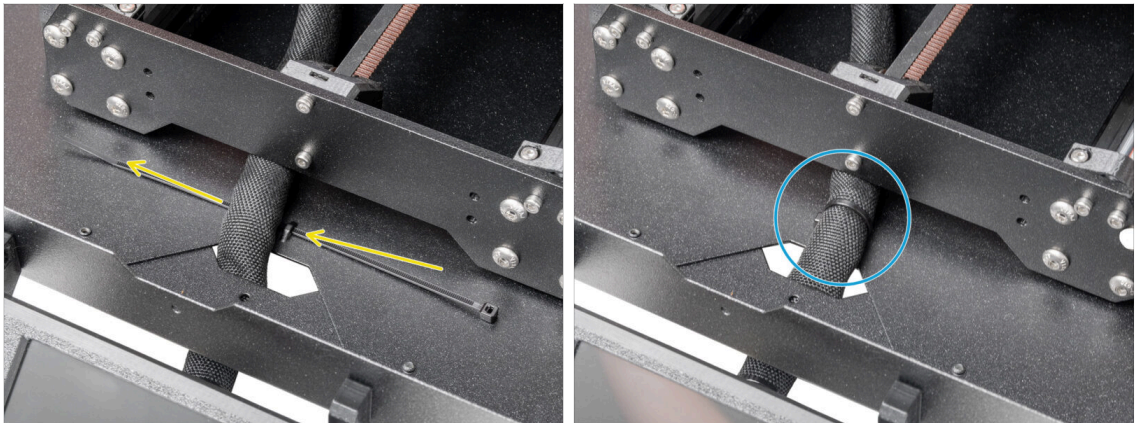

- Guide the zip tie through the perforation in the bottom panel and under the xLCD cable bundle.
- Tighten the zip tie to secure the xLCD cable bundle. **Do not over tighten the zip tie, it may cut the cables!**

## STEP 22 Assembling the filament guide: parts preparation

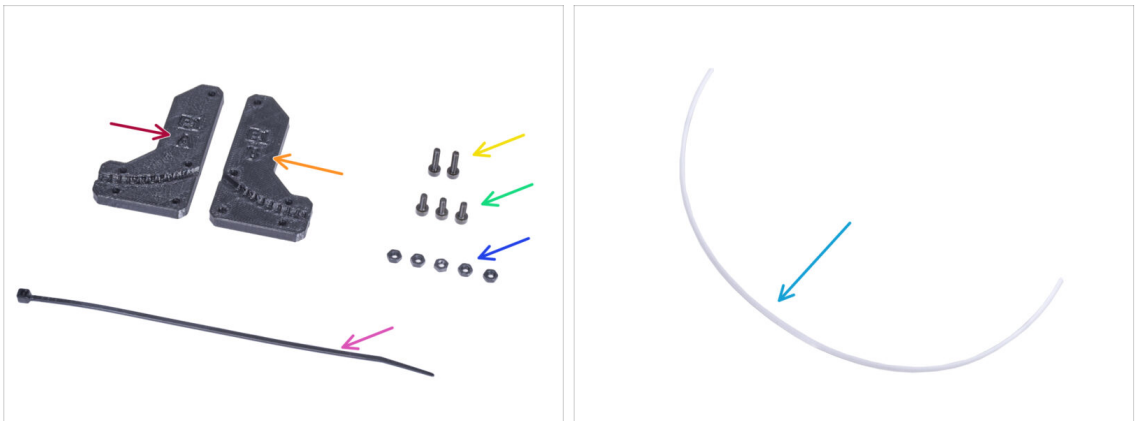

### ● For the following steps, please prepare:

- Filament-guide-a (1x)
- Filament-guide-b (1x)
- M3n nut (5x)
- M3x12 screw (2x)
- M3x8 screw (3x)
- Zip-tie (1x)
- PTFE tube (1x) 2.5x4x650 mm



## STEP 23 Assembling the filament guide



- ◆ Insert five M3n nuts into the Filament-guide-a.
- ◆ Attach the Filament-guide-b on the Filament-guide-a part and join them together by three M3x8 screws. **Do not tighten the screws completely**, a few turns are enough for now.
- ◆ Slide the PTFE tube all the way into the hole in the filament guide. From the opposite side, **check if the PTFE tube is completely inserted to the end**. If not, slide the PTFE a little more. See the direction of the PTFE tube.

## STEP 24 Mounting the filament guide



- ◆ Tighten all screws on the filament guide assembly. Do not overtighten the screws! Check that the filament passes easily through the PTFE!
- ⚠ **Do not overtighten the screws! Check that the filament passes easily through the PTFE!**
- ◆ Align the holes in the filament guide and holes in the front-right top corner of the frame. See the orientation of the filament guide.
- ◆ Secure the filament guide to the frame with two M3x12 screws.

## STEP 25 Guiding the PTFE tube

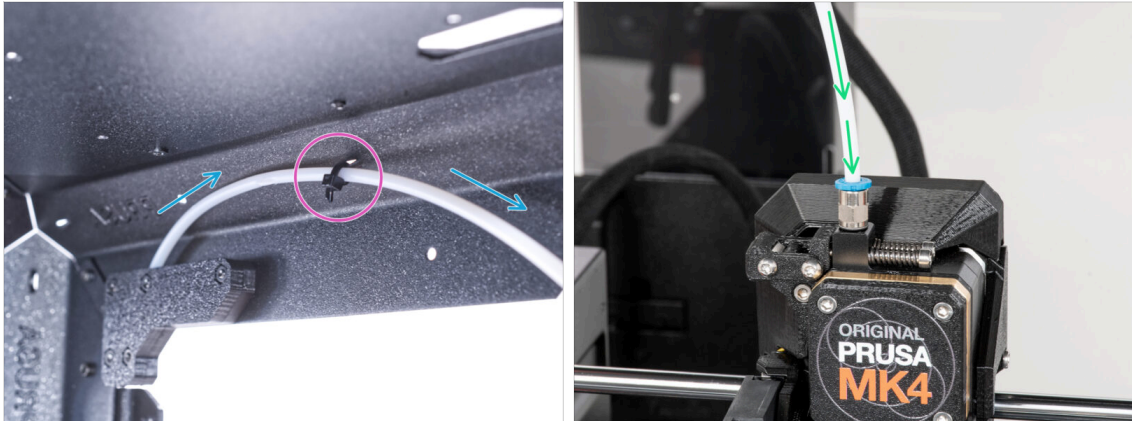

- ◆ Guide the PTFE tube to the front top right of the frame.
- ◆ Secure the tube with the zip tie to the frame.
- ◆ Insert the free end of the PTFE tube to the Fitting QSM-M5 on the extruder. Insert it all the way down.

## STEP 26 Assembling the thermometer: parts preparation



- ◆ **For the following steps, please prepare:**
- ◆ Temperature sensor (1x)
- ◆ Thermometer-bracket (1x)
- ◆ M3x8 screw (2x)
- ◆ M3n nut (2x)

## STEP 27 Assembling the thermometer



- Insert two M3n nuts into the Thermometer-bracket.
- Pull out the plastic tab from the temperature sensor.
- Insert the temperature sensor in the Thermometer-bracket. Push on it by your thumbs until you feel a slight "click". **Avoid pressing on the screen, you can damage it.**
- From the inside, mount the thermometer to the top left corner. Secure it with two M3x8 screws.

## STEP 28 Assembling doors: parts preparation



For the following steps, please prepare:

- Door panel (2x)
- Door-magnet-a (2x)
- Door-magnet-b (2x)
- Door handle (2x)
- Door trim (2x)

**i** The list continues in the next step...

## STEP 29 Assembling doors: parts preparation

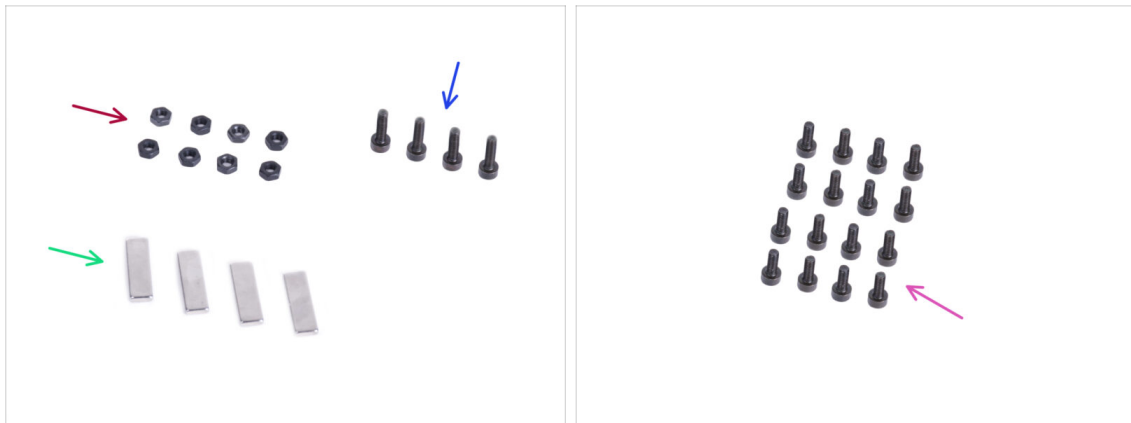

● For the following steps, please prepare:

- M3n nut (8x)
- M3x12 screw (4x)
- Magnet 20x6x2 (4x)
- M3x8 screw (16x)

## STEP 30 Assembling the door magnets



- There is a pocket in each Door-magnet (A and B) part. Place the magnet close to the pocket. **The polarity of the magnet is not important.**
- Push the magnet all the way into the pocket.
- Insert two M3n nuts into each Door-magnet (A and B) part.

## STEP 31 Assembling doors



- There are protective foils on both sides of the panel. Peel off both foils.
- Place the edge of the door panel on the door trim. Both sides of the panel are symmetrical. It doesn't matter which side you put it on the door trim. It is important that the circular hole is placed on the door trim.
- Align the edges of the door panel with both ends of the door trim.
- Proceed the same with the second door panel.
- ⓘ In the next step, we will need door-magnet-a and door-magnet-b. **These parts are not the same!** Both parts are marked with the letter "A" and "B" and have a different shape.

## STEP 32 Installing the door magnets



⚠ **Do not overtighten the screws in the door panel! The panel could crack.**

- Insert the door-magnet-a under the left side of the door trim and the door panel.
- Secure it with two M3x8 screws.
- Insert the door-magnet-b under the right side of the door trim and the door panel.
- Secure it with two M3x8 screws.
- Compare the final look of the panel.
- Proceed the same with the second door assembly.

## STEP 33 Mounting the door handles

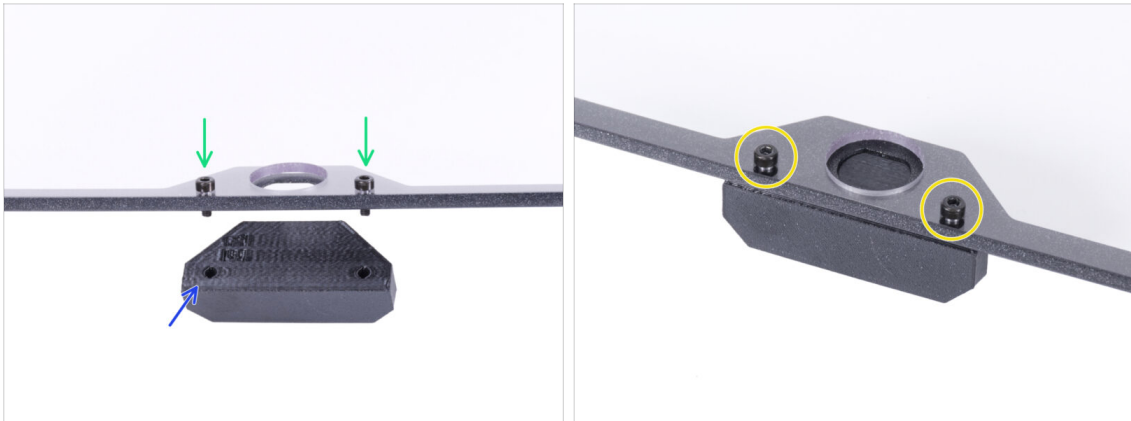



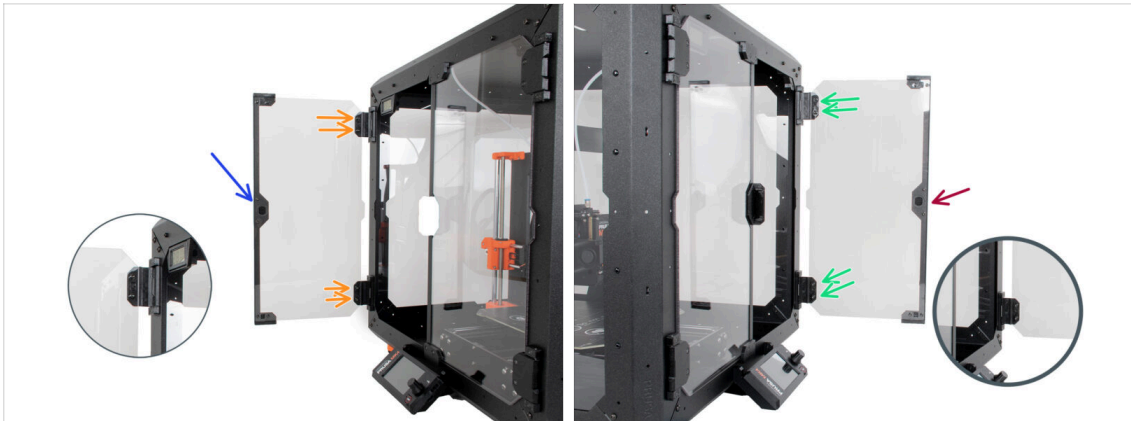

**⚠ Do not overtighten the screws in the door panel! The panel could crack.**

- 🟢** Insert two M3x12 screws through the holes in the door assembly. In the picture, **notice from which side the screws are inserted.**
- 🟡** Place the Door-handle under the door assembly and align the holes with the screws.
- 🟠** Join the parts together by tightening the M3x12 screws.
- ⬛** Proceed the same with the second door assembly.

## STEP 34 Installing the door





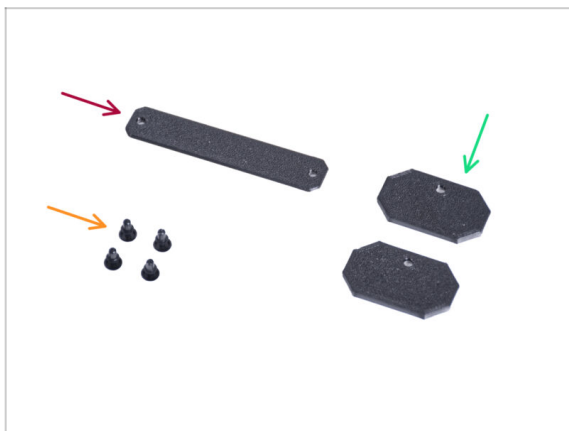

 **Do not overtighten the screws in the door panel! The panel could crack.**

-  Take one of the door assemblies and place it on the open hinges on the right side of the enclosure. **Make sure the handle is on the outside of the panel.**
-  Secure the door assembly by tightening two M3x8 screws in each hinge.
-  Look at the detail for a better illustration of how the door panel is attached to the hinge.
-  Take the second door assembly and place it on the open hinges on the left side of the enclosure. **Make sure the handle is on the outside of the panel.**
-  Secure the door assembly by tightening two M3x8 screws in each hinge.

## STEP 35 Installing the top plugs



-  **For the following steps, please prepare:**
-  Top-plug-center (1x)
-  Top-plug-edge (2x)
-  Nylon rivet (4x)

## STEP 36 Installing the top plugs

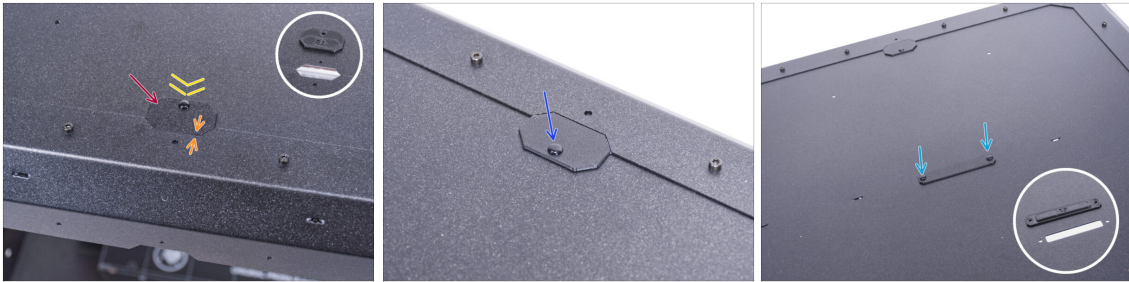

- Insert the Top-plug-edge to the cutout in the front of the top panel.
- The top surface of the printed part must be flushed with the top surface of the profile.
- Secure it with the nylon rivet.
- Install the second Top-plug-edge to the same cutout on the rear side of the top panel. Secure it with the nylon rivet.
- Insert the Top-plug-center in the rectangular cutout in the center of the top panel. Secure it with two nylon rivets.

## STEP 37 Removing the side arm

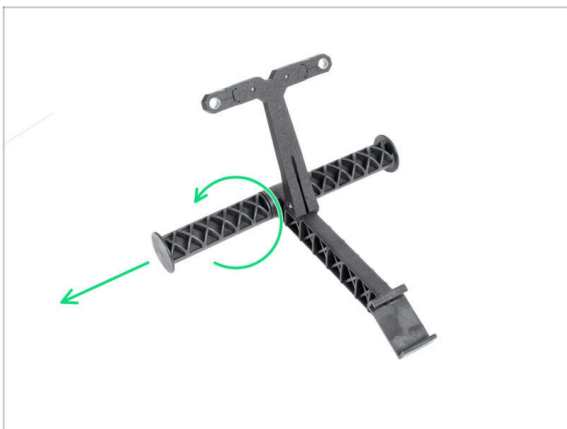

- Take the spool holder that you remove from the printer.
- Turn one arm counterclockwise to release it from the spool holder.



## STEP 38 Installing spool holder: parts preparation

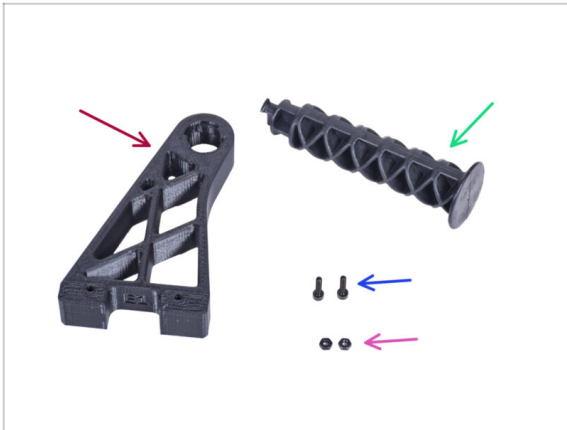

◆ For the following steps, please prepare:

- ◆ Spool-holder-r (1x)
- ◆ Side arm (1x)
- ◆ M3x12 screw (2x)
- ◆ M3n nut (2x)

## STEP 39 Installing spool holder

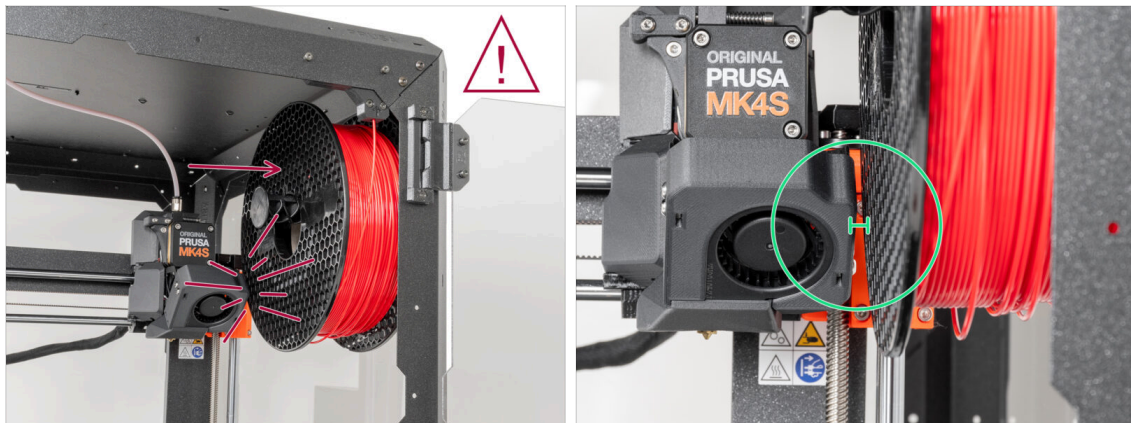

- ◆ Completely insert two M3n nuts into the holes in the Spool-holder-r.
- ◆ From the inside, attach the Spool-holder-r to the corner on the right side of the enclosure. Secure it with two M3x12 screws. See the orientation of the Spool-holder-r.
- ◆ Insert the side arm into the Spool-holder-r and turn counter-clockwise to lock it.

**STEP 40** MK4S Spool installation

- ◆ After assembly, **ensure there is sufficient space between the inside wall of the enclosure and the Nextruder when it is in the top-right position.** When printing at the full height of the printer, the Nextruder may come into contact with the filament spool. To prevent this, place the spool on the spool holder as far to the right as possible.
- ◆ Prusament spools are not affected by this when positioned correctly.

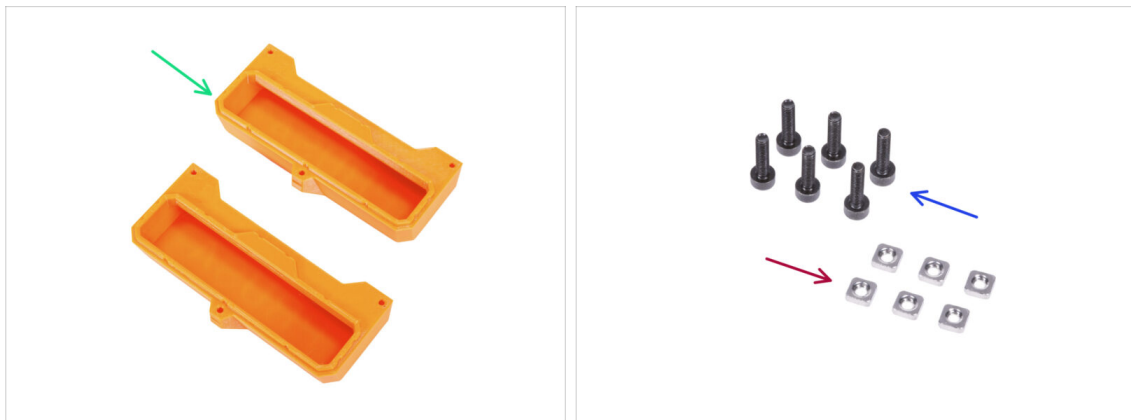
**STEP 41** Transport handle (optional): parts preparation

- ◆ These instructions are the same for the **Original Prusa MK4/3.9.**
- i Some of the following steps are marked as optional. If you do not need to install the handles at this time, skip to **Reward yourself!**
- ◆ **For the following steps, please prepare:**
  - ◆ Transport-handle (2x) *this part is not included in the package, you will need to print it out*
  - ◆ M3nS nut (6x)
  - ◆ M3x12 screw (6x)

## STEP 42 Installing the transport handle (optional)



- ✦ Insert two M3nS nuts from the side into each Transport-handle.
- ✦ Insert the M3nS nut from the other side into each Transport-handle.
- ✦ Using the knife, CAREFULLY cut off all supports of each handle cutout on the side panels and remove it.

## STEP 43 Installing the transport handle (optional)



- ✦ From the inside of the enclosure, push on the nylon rivets using the pliers. And pull them out from the outside.
- ✦ From the inside, place the Transport-handle into the same shape cutout.
- ✦ Secure it with three M3x12 screws.
- ✦ Repeat the same procedure for the second Transport-handle.

## STEP 44 Reward yourself!



- Wasn't it difficult? Of course not. We hope you enjoyed the assembling. **Don't forget to reward yourself.**
- Eat the remaining gummy bears.

## STEP 45 That's it!

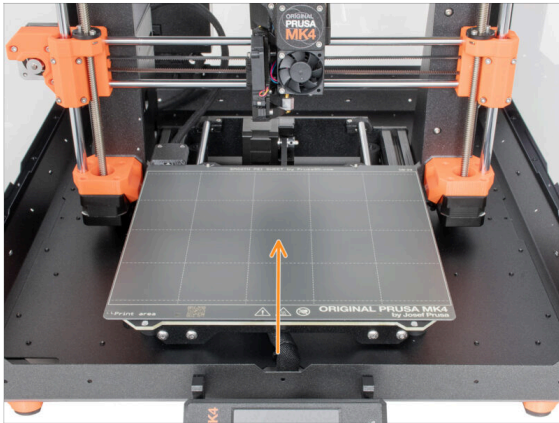

- **Before you start printing with the printer in the enclosure, do the following:**

- Place the steel sheet on the heatbed. Double-check it is oriented correctly.
- On the printer screen navigate to *Calibration & Tests* -> *Calibrate Z* and following the instructions on the display.

- **Well done! You just successfully assembled the Original Prusa Enclosure.**

⚠ **IMPORTANT:** Before you start using the enclosure, read the user guide shipped in your package and read the article about how to care of the side panels.

## STEP 46 Enclosure add-ons

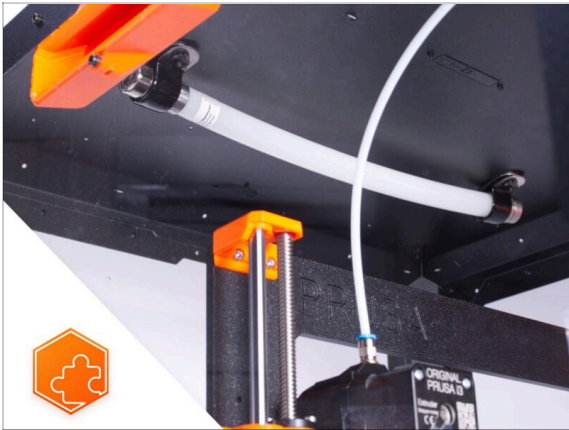

- ① The procedure for installing the listed add-ons is common for both the MK3S+, MK4 and MK3.9.
- ◆ List of available guides for Enclosure add-ons:
  - ◆ [Fire Suppression System](#)
  - ◆ [Hinged Lid](#)
  - ◆ [Advanced filtration system](#)
  - ◆ [Mechanical lock](#)
  - ◆ [White LED strip](#)
  - ◆ [Quick release PSU cable - MK4/MK3.9 Black PSU \(add-on\)](#)



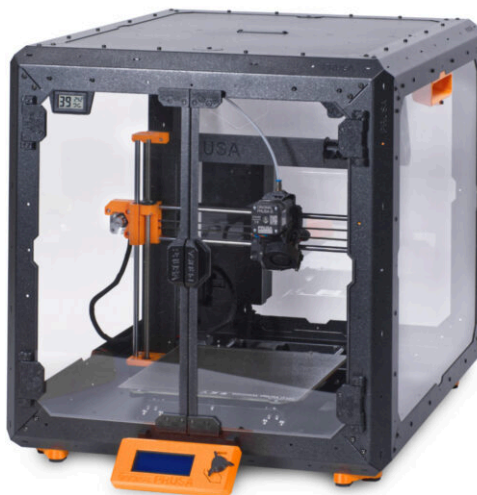

## 4B. Installing the printer (MK3S+ Black PSU)

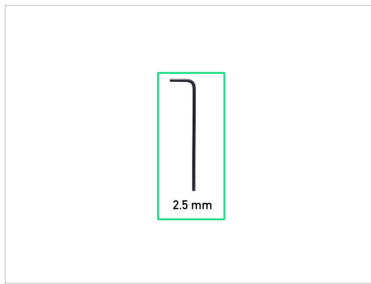

## STEP 1 Tools necessary for this chapter





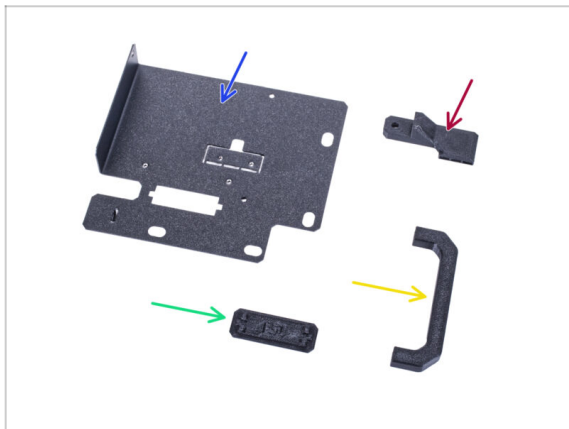

### For this chapter, please prepare:

-  2.5mm Allen key
-  Needle-nose pliers
-  Phillips screwdriver PH2
-  Pocket knife or snap-off knife

## STEP 2 Assembling the PSU holder: parts preparation



### For the following steps, please prepare:

-  PSU holder (1x)
-  PSU-handle (1x)
-  PSU-retainer (1x)
-  PSU-holder-plug (1x)
-  The list continues in the next step...

### STEP 3 Assembling the PSU holder: parts preparation



● For the following steps, please prepare:

- M3x12 screw (4x)
- Standoff (2x)
- M3nS nut (2x)
- 6/32" screw (1x)
- M4x5r screw (1x)
- Magnet 20x6x2 (3x)

### STEP 4 Assembling the PSU holder

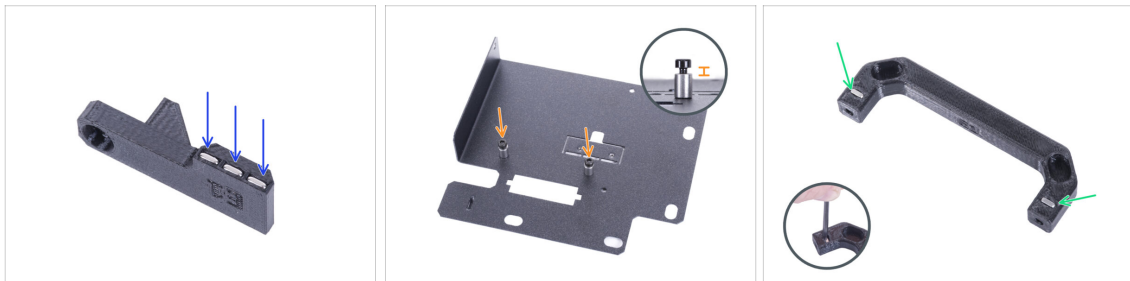

- Push three magnets into the PSU-retainer. **The polarity of the magnet is not important.**
- Screw two M3x12 screws with two standoffs into the PSU-holder. **Do not tighten the screw completely!** There must be 2-3 mm space between the screw head and the standoff.
- Insert two M3nS nuts into the PSU-handle. Use the 2.5 mm Allen key to completely push the nuts inside.



## STEP 5 Assembling the PSU holder

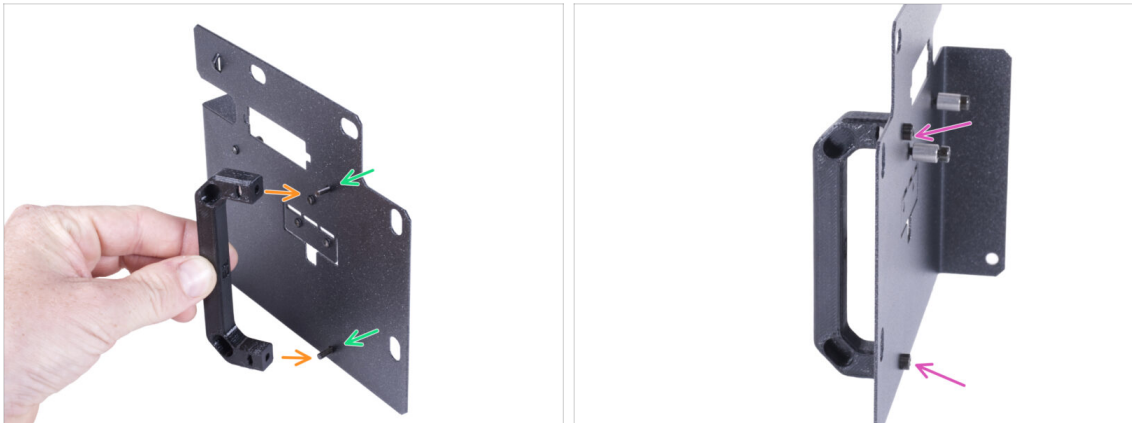

- Push two M3x12 screws through the holes in the PSU holder.
- Align the PSU-handle with the screws. Maintain the same orientation of the PSU-handle, like in the picture - see the pockets.
- Join the handle with PSU holder by tightening both M3x12 screws.

## STEP 6 Assembling the PSU holder

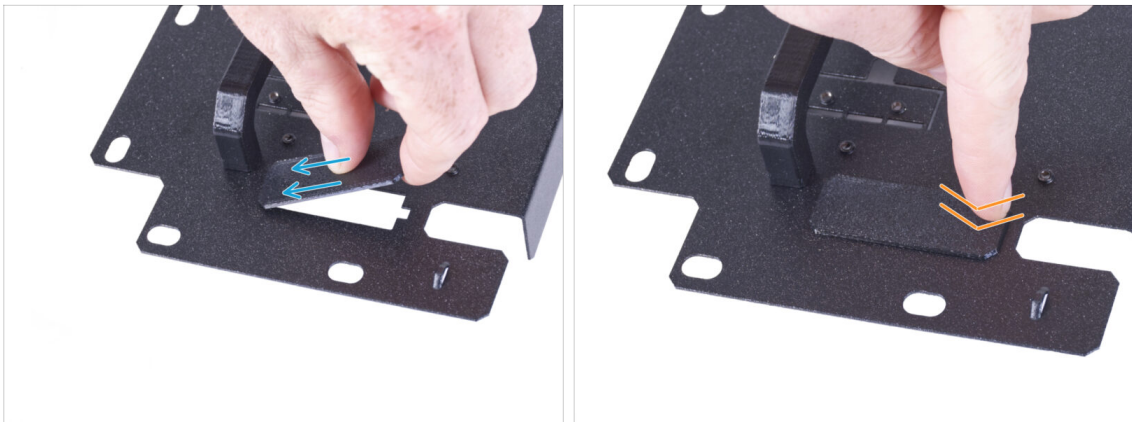

- ⓘ If you have purchased the Quick release cable add-on, you do not need to install this cover.
- Slide one end of the PSU holder cover into the opening in the PSU holder.
- Push on the other end into the opening. You should feel slightly "click" to ensure the part fits properly.

## STEP 7 Assembling the PSU holder

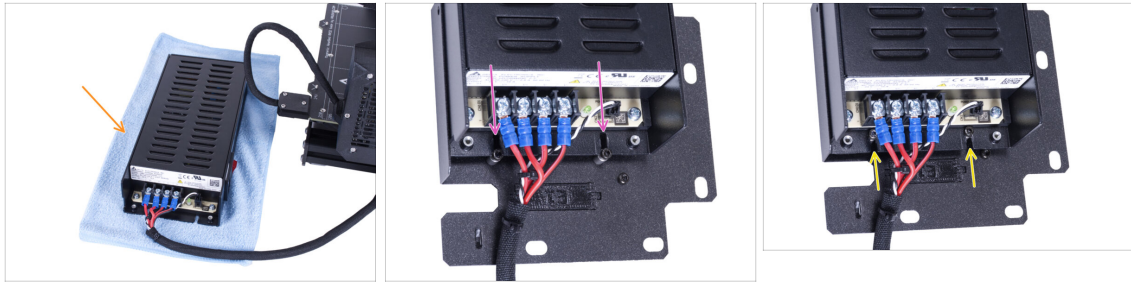

- Prepare the printer with the PSU. Place the PSU on the cloth.
- Align the open grooves in the PSU against the screws on the PSU holder.
- Slide the PSU on these screws and tighten the screws.

## STEP 8 Assembling the PSU holder



- On the PSU side, align the hole in the PSU holder with the hole in the PSU.
- Secure both parts with the M4x5r screw.
- Using the 6/32" screw, attach the PSU-retainer to the corner of the PSU as shown in the picture. Note the correct orientation of the parts.

## STEP 9 Covering the PSU: parts preparation



● For the following steps, please prepare:

- PSU-cover (1x) *re-use the old part*
- M3x10 screw (2x) *re-use the old part*
- Zip tie (1x)

## STEP 10 Covering the PSU



- Mount the PSU cover back on the PSU using two M3x10 screws.

## STEP 11 Guiding the PSU cable bundle



- ◆ Guide the PSU cable bundle through the opening in the PSU holder.
- ◆ From the rear side of the PSU holder, push the zip tie through the perforation on the holder.
- ◆ Tighten the zip tie around the PSU cable bundle.
- ◆ Carefully put the printer with the PSU aside for now. We will come back to it in a while.

## STEP 12 Installing the printer

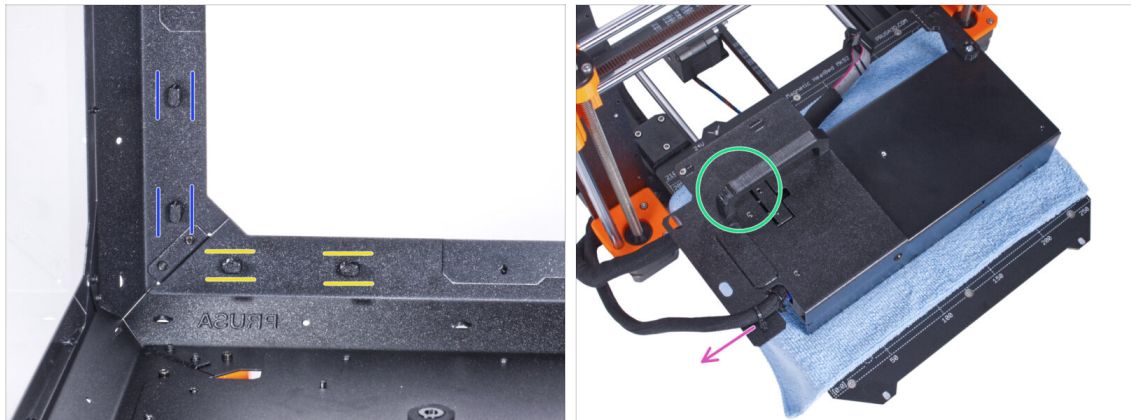

- ◆ Ensure the PSU-locks are still turned at the same position:
  - ◆ **On the bottom frame**, turn the PSU-locks to the horizontal position.
  - ◆ **On the support**, turn the PSU-lock to the vertical position.
- ◆ Place the PSU on the heatbed protected with the cloth.
- ◆ Turn it with the PSU-handle facing upwards.
- ◆ The PSU cable bundle must guide to the left.

## STEP 13 Installing the printer

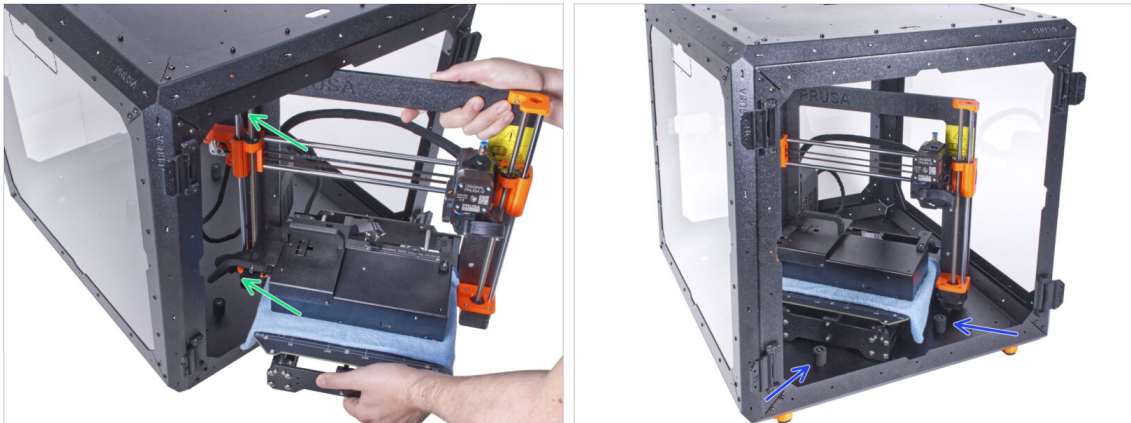

- To get the printer into the enclosure, insert its left side first.
- ⚠ **Avoid scratching the side panels with the printer!**
- Place the printer at an angle (as shown in the picture) in the enclosure behind the anti-slip dampers.
- ⓘ It's just a temporary position for the printer. We will adjust the correct position later.

## STEP 14 Installing the PSU

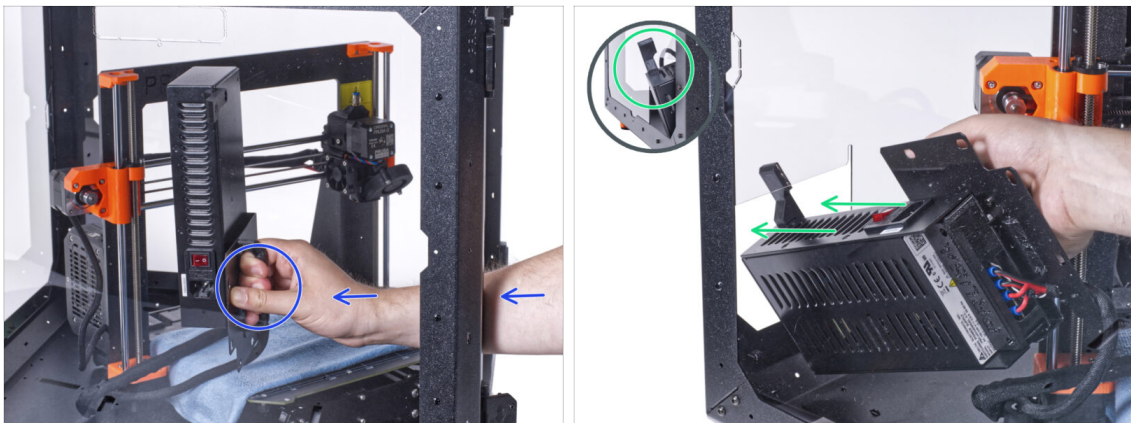

- From inside the enclosure, grasp the PSU by its handle in your hand.
- ⓘ It is more convenient to use the right hand.
- Insert the PSU through the hole at the bottom of the back panel. Start by pushing through the part with the PSU-retainer (the part with the magnets).

## STEP 15 Installing the PSU

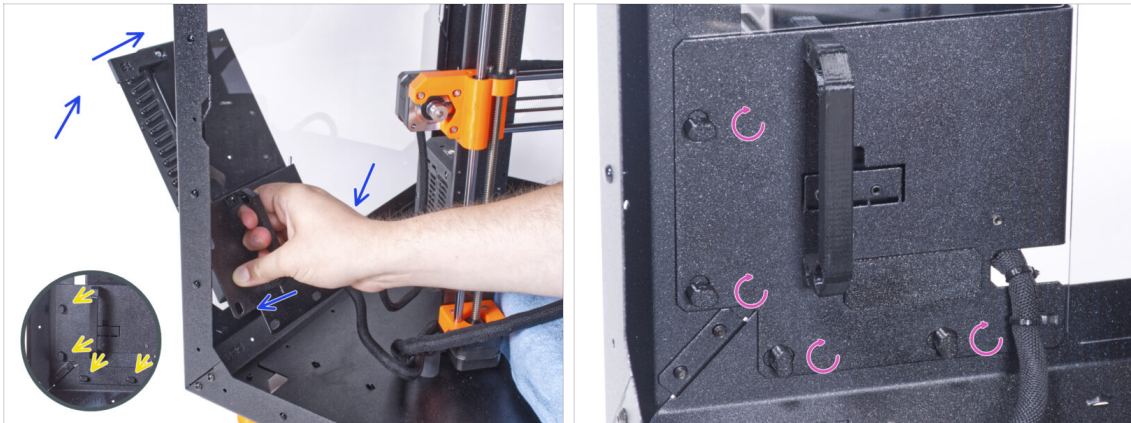

- ◆ Tilt the PSU towards the back panel. The PSU must be outside the enclosure and the PSU holder inside the enclosure.
- ◆ **The PSU holder must fit perfectly on all four PSU-locks.**
- ◆ Turn all PSU-lock 90° to lock the PSU assembly.

## STEP 16 Adjusting the printer

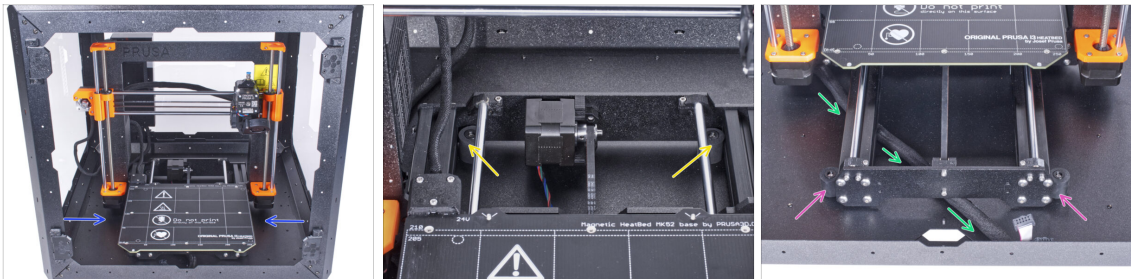

- ◆ Rearrange position of the printer like in the picture. Place it in the center of the enclosure and adjust the correct position:
  - ◆ The two rear anti-slip dampers must be locked against the rear plate from the inside.
  - ◆ The two front anti-slip dampers must be locked from the outside by the front plate.
- ◆ Guide the LCD cable bundle under the printer from the electronics to the front side of the enclosure. Leave the cable free for now.

## STEP 17 Mounting the LCD: parts preparation

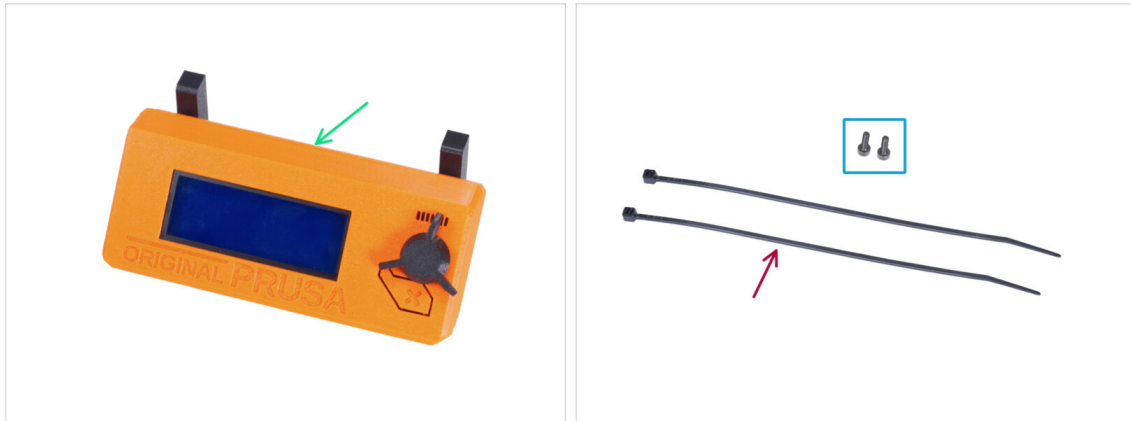

For the following steps, please prepare:

- LCD assembly (1x)
- M3x8 screw (2x)
- Zip tie (2x)

## STEP 18 Mounting the LCD

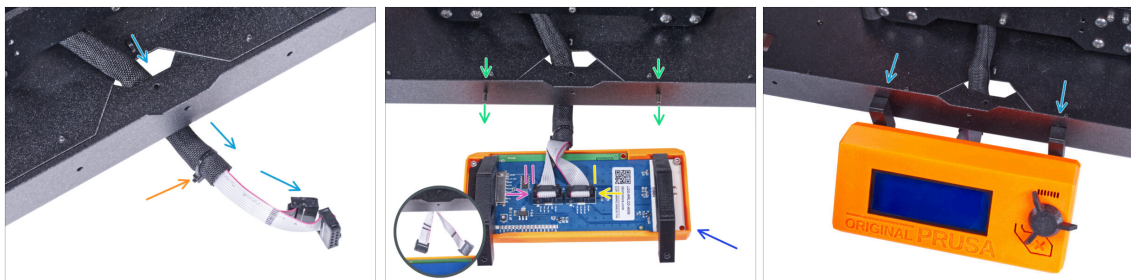

- Guide the LCD cable through the cutout in the bottom panel.
- Secure the textile sleeve on the cable bundle with the zip tie. **Do not over tighten the zip tie**, it may cut the cables!
- From the inside, push two M3x8 screws through the bottom profile.
- Place the LCD assembly close to the LCD cables, like in the picture. Mind the same orientation of the LCD as in the picture. See the LCD-supports for better understanding.

**⚠ Note that both cables are marked with stripes on one side. Correct connection order is important!**

- Connect the LCD cable marked with **TWO STRIPES** to the **left slot** (called EXP2) on the LCD controller.
- Connect the LCD cable marked with **ONE STRIPE** to the **right slot** (called EXP1) on the LCD controller.
- Slide the LCD assembly onto the two M3x8 screws in the frame and tighten them.

## STEP 19 Securing the LCD cable

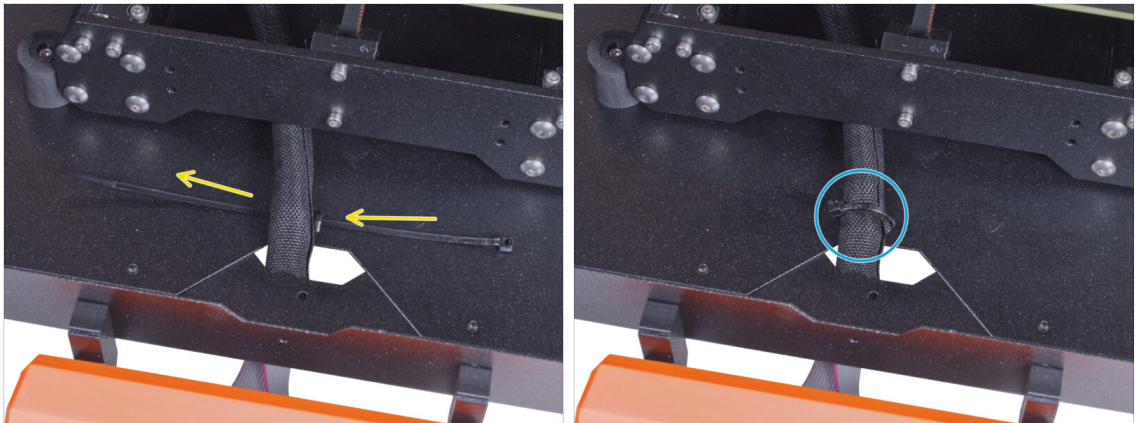

- Guide the zip tie through the perforation in the bottom panel and under the LCD cable bundle.
- Tighten the zip tie to secure the LCD cable bundle. **Do not over tighten the zip tie**, it may cut the cables!

## STEP 20 Assembling the filament guide: parts preparation

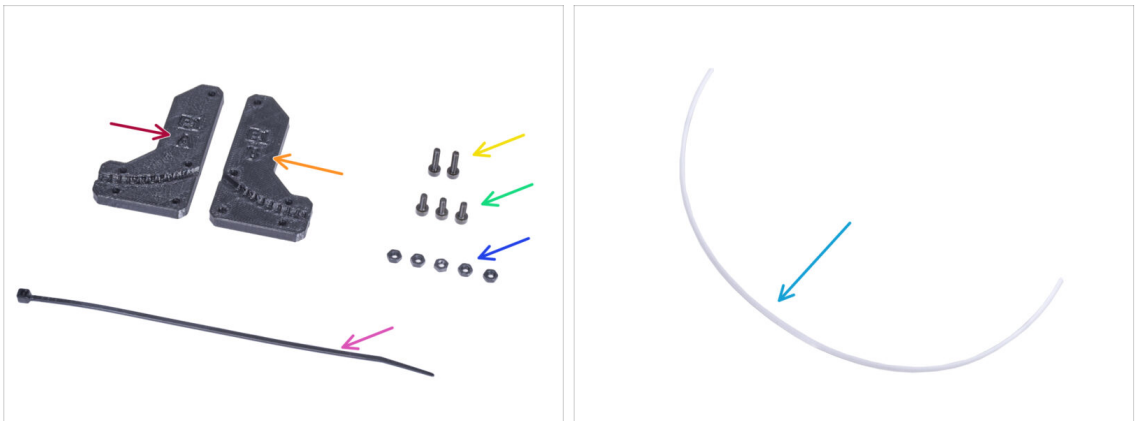

● **For the following steps, please prepare:**

- Filament-guide-a (1x)
- Filament-guide-b (1x)
- M3n nut (5x)
- M3x12 screw (2x)
- M3x8 screw (3x)
- Zip-tie (1x)
- PTFE tube (1x) 4x650 mm



## STEP 21 Assembling the filament guide



- ◆ Insert five M3n nuts into the Filament-guide-a.
- ◆ Attach the Filament-guide-b on the Filament-guide-a part and join them together by three M3x8 screws. **Do not tighten the screws completely**, a few turns are enough for now.
- ◆ Slide the PTFE tube all the way into the hole in the filament guide. From the opposite side, **check if the PTFE tube is completely inserted to the end**. If not, slide the PTFE a little more. See the direction of the PTFE tube.

## STEP 22 Mounting the filament guide



- ◆ Fully tighten all screws on the filament guide assembly.
- ◆ Align the holes in the filament guide and holes in the front-right top corner of the frame. See the orientation of the filament guide.
- ◆ Secure the filament guide to the frame with two M3x12 screws.

## STEP 23 Guiding the PTFE tube

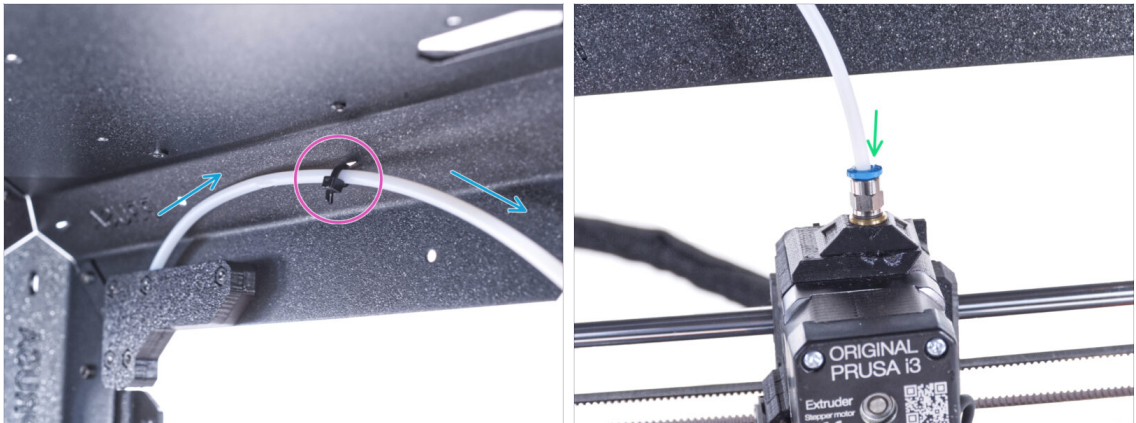

- ◆ Guide the PTFE tube to the top frame.
- ◆ Secure the tube with the zip tie to the frame.
- ◆ Insert the free end of the PTFE tube to the Fitting QSM-M5 on the extruder. Insert it all the way down.

## STEP 24 Assembling the thermometer: parts preparation



- ◆ **For the following steps, please prepare:**
- ◆ Temperature sensor (1x)
- ◆ Thermometer-bracket (1x)
- ◆ M3x8 screw (2x)
- ◆ M3n nut (2x)

## STEP 25 Assembling the thermometer



- ◆ Insert two M3n nuts into the Thermometer-bracket.
- ◆ Insert the temperature sensor in the Thermometer-bracket. Push on it by your thumbs until you feel a slight "click". **Avoid pressing on the screen, you can damage it.**
- ◆ From the inside, mount the thermometer to the top left corner. Secure it with two M3x8 screws.

## STEP 26 Assembling doors: parts preparation



◆ **For the following steps, please prepare:**

- ◆ Door panel (2x)
- ◆ Door-magnet-a (2x)
- ◆ Door-magnet-b (2x)
- ◆ Door handle (2x)
- ◆ Door trim (2x)

ⓘ The list continues in the next step...

## STEP 27 Assembling doors: parts preparation

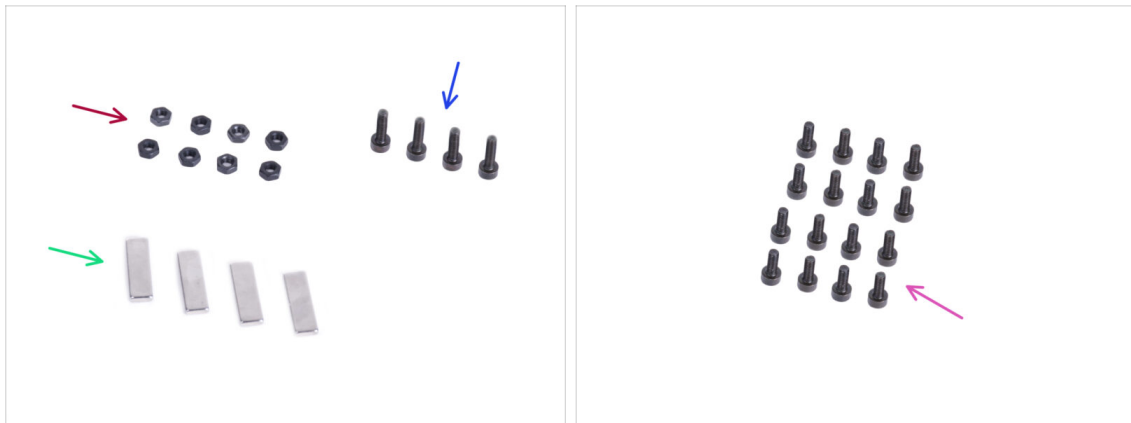

● For the following steps, please prepare:

- M3n nut (8x)
- M3x12 screw (4x)
- Magnet 20x6x2 (4x)
- M3x8 screw (16x)

## STEP 28 Assembling the door magnets



- There is a pocket in each Door-magnet (A and B) part. Place the magnet close to the pocket.
- Push the magnet all the way into the pocket.
- Insert two M3n nuts into each Door-magnet (A and B) part.

## STEP 29 Assembling doors



- There are protective foils on both sides of the panel. Peel off both foils.
- Place the edge of the door panel on the door trim. Both sides of the panel are symmetrical. It doesn't matter which side you put it on the door trim. It is important that the circular hole is placed on the door trim.
- Align the edges of the door panel with both ends of the door trim.
- Proceed the same with the second door panel.
- ⓘ In the next step, we will need door-magnet-a and door-magnet-b. **These parts are not the same!** Both parts are marked with the letter "A" and "B" and have a different shape.

## STEP 30 Installing the door magnets





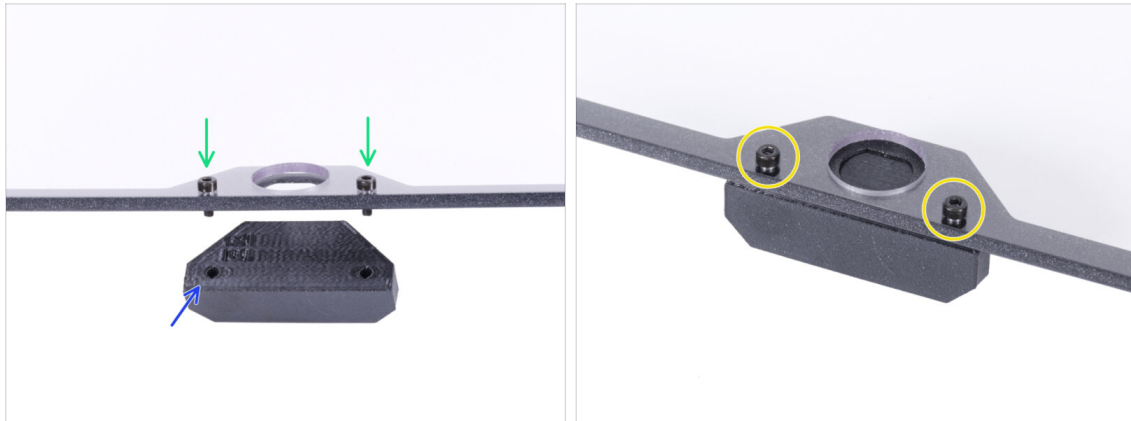

⚠ **Do not overtighten the screws in the door panel! The panel could crack.**

- Insert the door-magnet-a under the left side of the door trim and the door panel.
- Secure it with two M3x8 screws.
- Insert the door-magnet-b under the right side of the door trim and the door panel.
- Secure it with two M3x8 screws.
- Compare the final look of the panel.
- Proceed the same with the second door assembly.

## STEP 31 Mounting the door handles





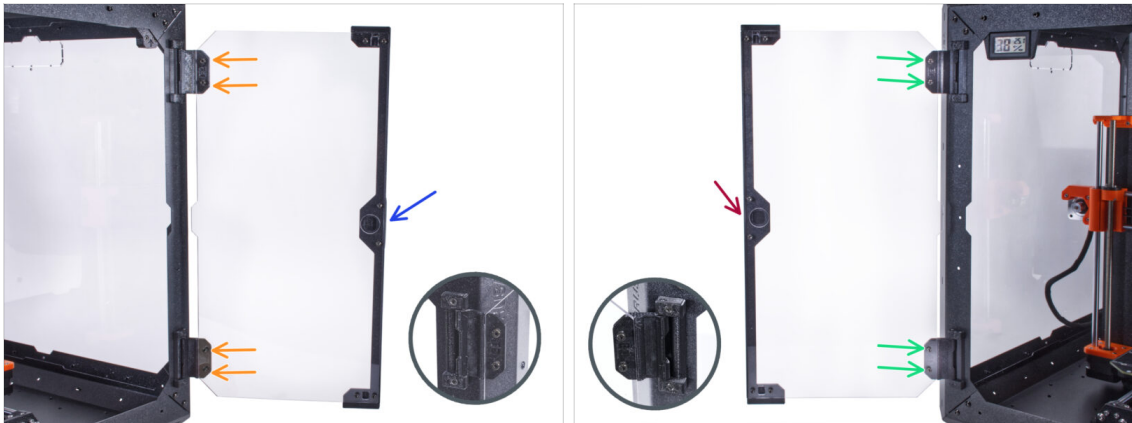

 **Do not overtighten the screws in the door panel! The panel could crack.**

-  Insert two M3x12 screws through the holes in the door assembly. In the picture, **notice from which side the screws are inserted.**
-  Place the Door-handle under the door assembly and align the holes with the screws.
-  Join the parts together by tightening the M3x12 screws.
-  Proceed the same with the second door assembly.

## STEP 32 Installing the door





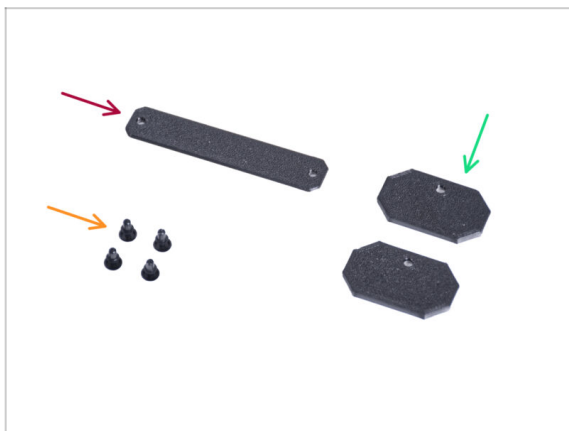

 **Do not overtighten the screws in the door panel! The panel could crack.**

-  Take one of the door assemblies and place it on the open hinges on the right side of the enclosure. **Make sure the handle is on the outside of the panel.**
-  Secure the door assembly by tightening two M3x8 screws in each hinge.
-  Look at the detail for a better illustration of how the door panel is attached to the hinge.
-  Take the second door assembly and place it on the open hinges on the left side of the enclosure. **Make sure the handle is on the outside of the panel.**
-  Secure the door assembly by tightening two M3x8 screws in each hinge.

## STEP 33 Installing the top plugs



-  **For the following steps, please prepare:**
-  Top-plug-center (1x)
-  Top-plug-edge (2x)
-  Nylon rivet (4x)

## STEP 34 Installing the top plugs

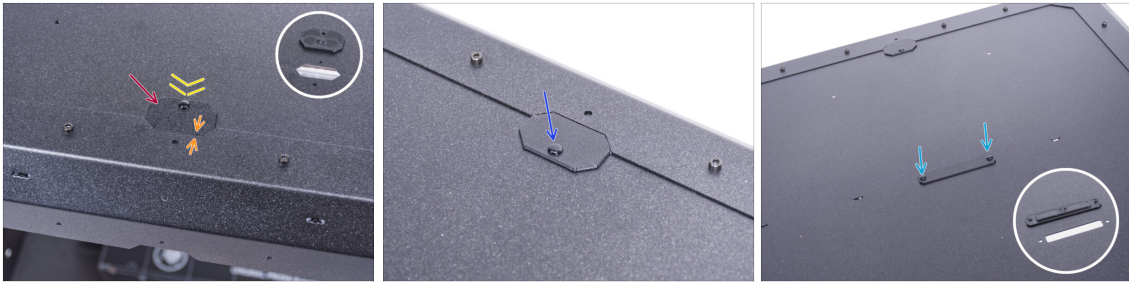

- Insert the Top-plug-edge to the cutout in the front of the top panel.
- The top surface of the printed part must be flushed with the top surface of the profile.
- Secure it with the nylon rivet.
- Install the second Top-plug-edge to the same cutout on the rear side of the top panel. Secure it with the nylon rivet.
- Insert the Top-plug-center in the rectangular cutout in the center of the top panel. Secure it with two nylon rivets.

## STEP 35 Removing the side arm



- Take the spool holder that you remove from the printer.
- Turn one arm counterclockwise to release it from the spool holder.



## STEP 36 Installing spool holder: parts preparation

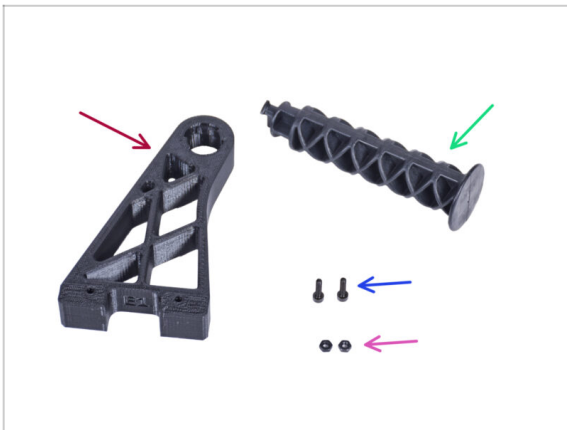

◆ For the following steps, please prepare:

- ◆ Spool-holder-r (1x)
- ◆ Side arm (1x)
- ◆ M3x12 screw (2x)
- ◆ M3n nut (2x)

## STEP 37 Installing spool holder



- ◆ Completely insert two M3n nuts into the holes in the Spool-holder-r.
- ◆ From the inside, attach the Spool-holder-r to the corner on the right side of the enclosure. Secure it with two M3x12 screws. See the orientation of the Spool-holder-r.
- ◆ Insert the side arm into the Spool-holder-r and turn counter-clockwise to lock it.

## STEP 38 Transport handle (optional): parts preparation



**i** Some of the following steps are marked as optional. If you do not need to install the handles at this time, skip to **Reward yourself!**

**■** For the following steps, please prepare:

- Transport-handle (2x) *this part is not included in the package, you will need to print it out*
- M3nS nut (6x)
- M3x12 screw (6x)

## STEP 39 Installing the transport handle (optional)



- Insert two M3nS nuts from the side into each Transport-handle.
- Insert the M3nS nut from the other side into each Transport-handle.
- Using the knife, **CAREFULLY** cut off all supports of each handle cutout on the side panels and remove it.

## STEP 40 Installing the transport handle (optional)



- ✦ From the inside of the enclosure, push on the nylon rivets using the pliers. And pull them out from the outside.
- ✦ From the inside, place the Transport-handle into the same shape cutout.
- ✦ Secure it with three M3x12 screws.
- ✦ Repeat the same procedure for the second Transport-handle.

## STEP 41 Reward yourself!



- ✦ Wasn't it difficult? Of course not. We hope you enjoyed the assembling. **Don't forget to reward yourself.**
- ✦ Eat the remaining gummy bears.

## STEP 42 That's it!

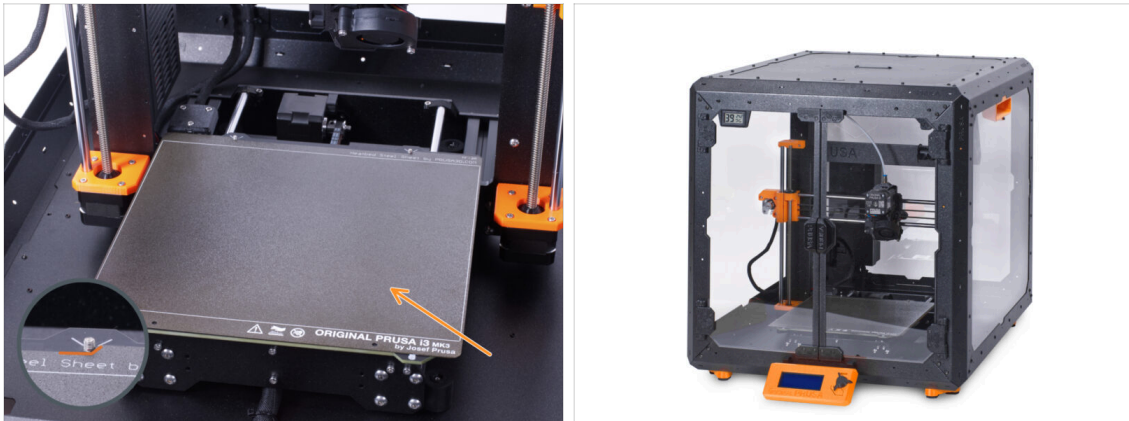

● **Before you start printing with the printer in the enclosure, do the following:**

- Place the steel sheet on the heatbed. Double-check it is oriented correctly.
- On the printer screen navigate to *Calibration* -> *Calibrate Z* and following the instructions on the display.

● **Well done! You just successfully assembled the Original Prusa Enclosure.**

⚠ **IMPORTANT:** Before you start using the enclosure, read the user guide shipped in your package and read the article about how to care of the side panels.

## STEP 43 Enclosure add-ons



● List of available guides for Enclosure add-ons:

- [Fire Suppression System](#)
- [Hinged Lid](#)
- [Advanced filtration system](#)
- [Mechanical lock](#)
- [Quick release PSU cable - MK3S+ Black PSU](#)
- [White LED strip](#)

## 4C. Installing the printer (MK3S+ Silver PSU)

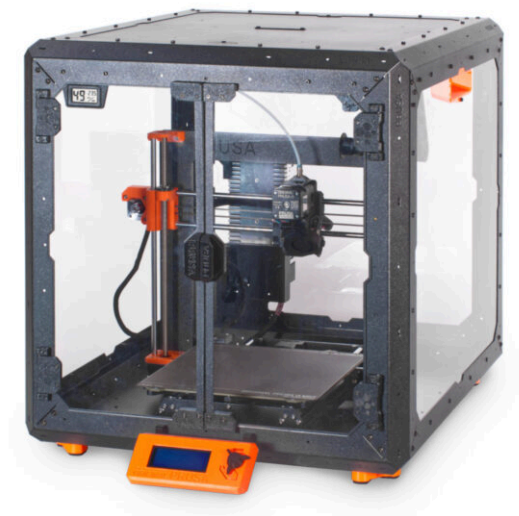

## STEP 1 Tools necessary for this chapter

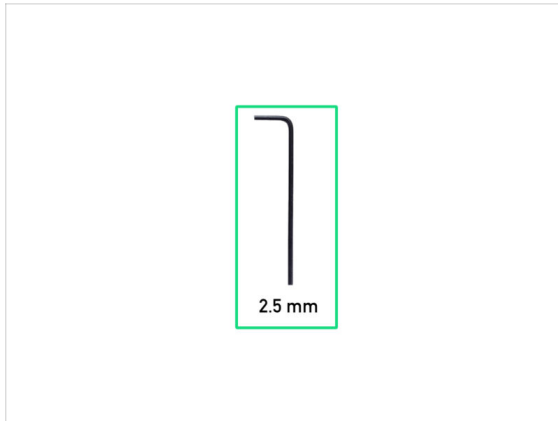

◆ For this chapter, please prepare:

- ◆ 2.5mm Allen key
- ◆ Needle-nose pliers

## STEP 2 Assembling the PSU holder: parts preparation

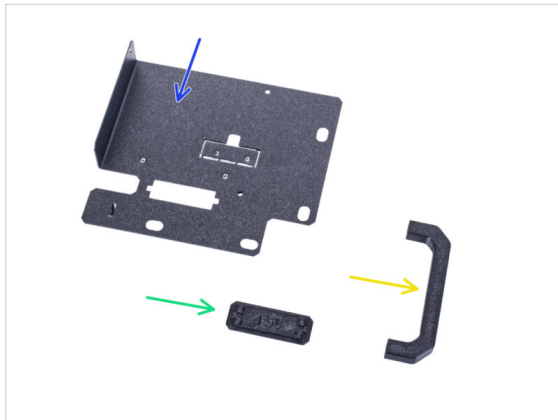

◆ For the following steps, please prepare:

- ◆ PSU holder (1x)
- ◆ PSU-handle (1x)
- ◆ PSU-holder-plug (1x)
- ◆ SILVER-PSU-retainer (1x) *the part you printed*

⚠ **Make sure you are using the correct part.** Compare with the picture. Do not use the PSU-retainer included in your kit.

ⓘ The list continues in the next step...

### STEP 3 Assembling the PSU holder: parts preparation



● For the following steps, please prepare:

- M3x12 screw (4x)
- M3nS nut (2x)
- M4x5r screw (2x)
- Magnet 20x6x2 (3x)

### STEP 4 Assembling the PSU holder

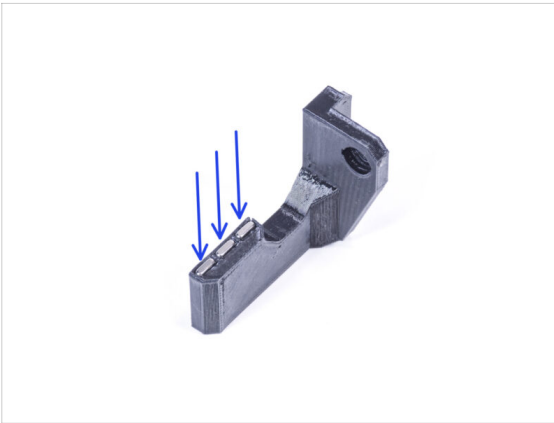

- Push three magnets into the Silver-PSU-retainer.
- Insert two M3nS nuts into the PSU-handle. Use the 2.5 mm Allen key to completely push the nuts inside.

## STEP 5 Assembling the PSU holder

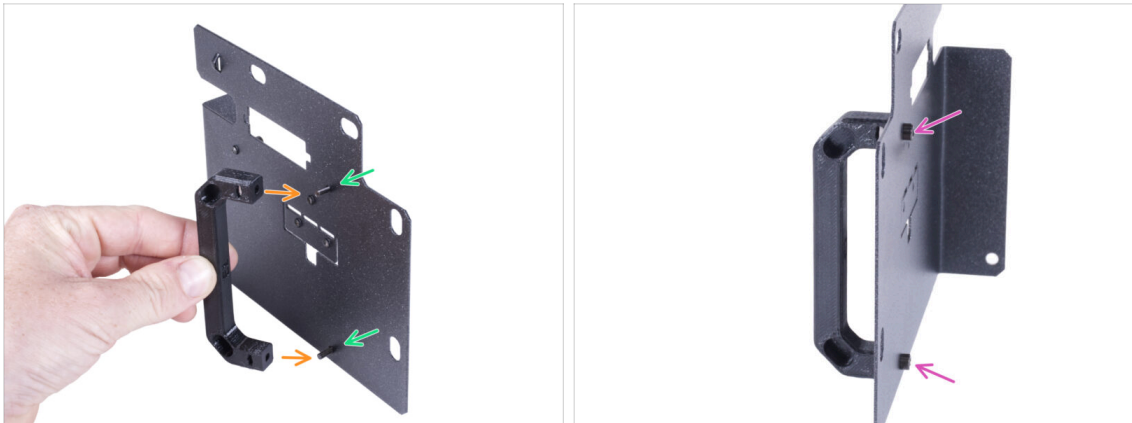

- Push two M3x12 screws through the holes in the PSU holder.
- Align the PSU-handle with the screws. Maintain the same orientation of the PSU-handle, like in the picture - see the pockets.
- Join the handle with PSU holder by tightening both M3x12 screws.

## STEP 6 Assembling the PSU holder

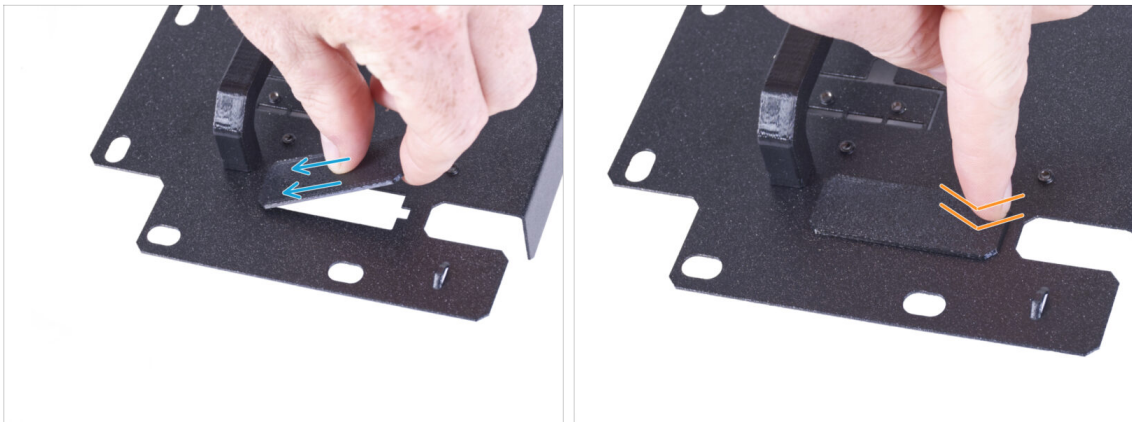

- Slide one end of the PSU holder cover into the opening in the PSU holder.
- Push on the other end into the opening. You should feel slightly "click" to ensure the part fits properly.



## STEP 7 Assembling the PSU holder



- On the side without PSU-handle on the PSU-holder locate the cutout.
- Bend the cutout by pushing your finger towards the side with the handle.
- Straighten the bent sheet to approximately 90°.

## STEP 8 Assembling the PSU holder



- Attach the PSU holder so that the plastic protrusion fits on the bent sheet. Secure it with two M3x12 screws.
- Guide the PSU cable bundle through the opening in the PSU holder.
- On the PSU side, align the hole in the PSU holder with the hole in the PSU.
- Secure both parts with the M4x5r screw.

## STEP 9 Attaching the SILVER-PSU-retainer



- On the side of the PSU locate the hole shown in the picture.
- Attach the SILVER-PSU-retainer to the PSU and align the holes in both parts. Secure both parts with M4x5r screw.

## STEP 10 Guiding the PSU cable bundle

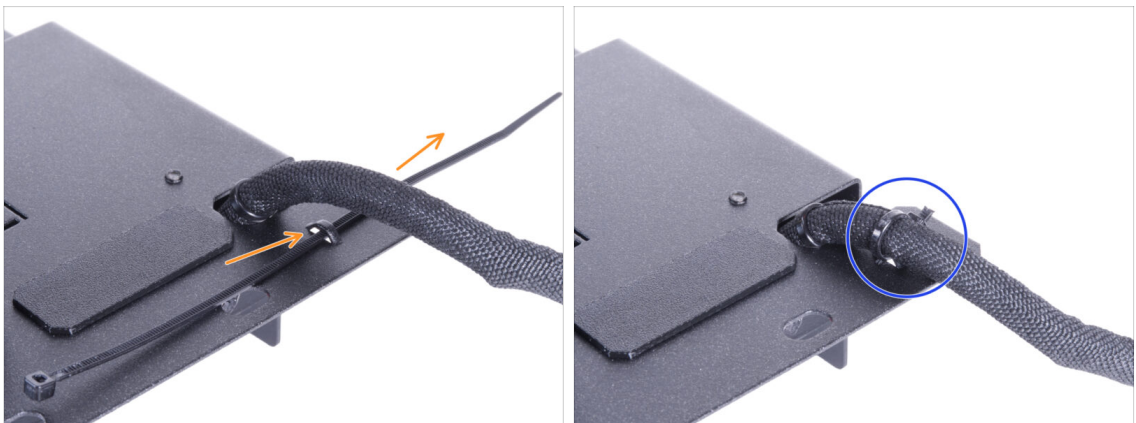

- From the rear side of the PSU holder, push the zip tie through the perforation on the holder.
- Tighten the zip tie around the PSU cable bundle.
- Carefully put the printer with the PSU aside for now. We will come back to it in a while.

## STEP 11 Installing the printer

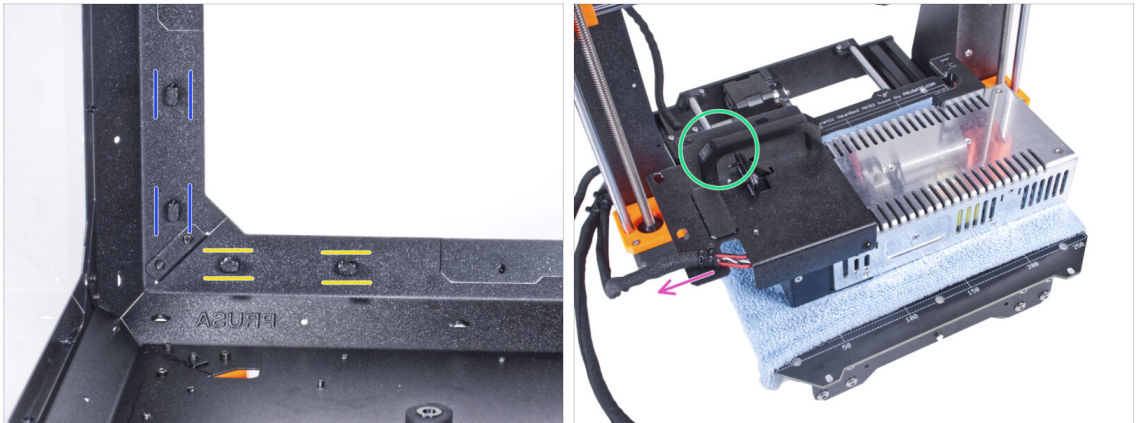

- Ensure the PSU-locks are still turned at the same position:
  - **On the bottom frame**, turn the PSU-locks to the horizontal position.
  - **On the support**, turn the PSU-lock to the vertical position.
- Place the PSU on the heatbed protected with cloth.
- Turn it with the PSU-handle facing upwards.
- The PSU cable bundle must guide to the left.

## STEP 12 Installing the printer

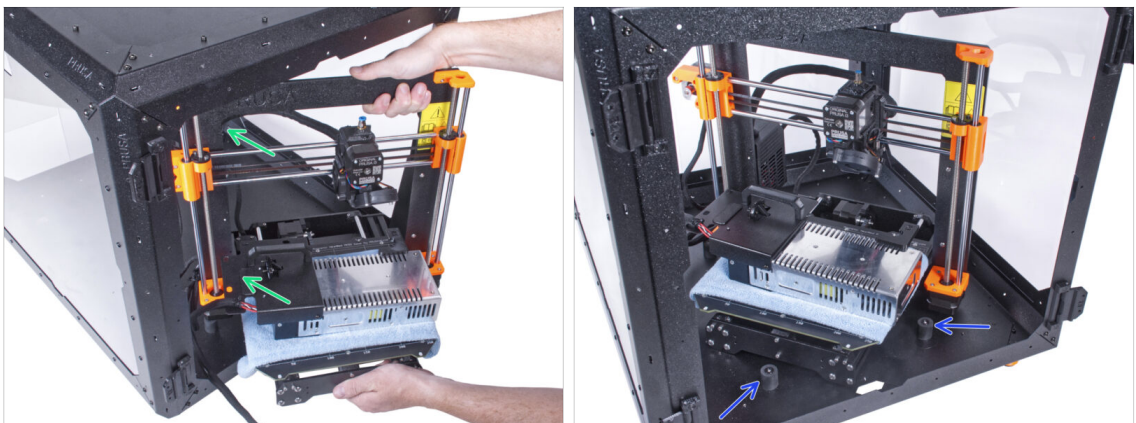

- To get the printer into the enclosure, insert its left side first.
  - ⚠ **Avoid scratching the side panels with the printer!**
- Place the printer at an angle (as shown in the picture) in the enclosure behind the anti-slip dampers.
- ⓘ It's just a temporary position of the printer. We will adjust the correct position later.

## STEP 13 Installing the PSU

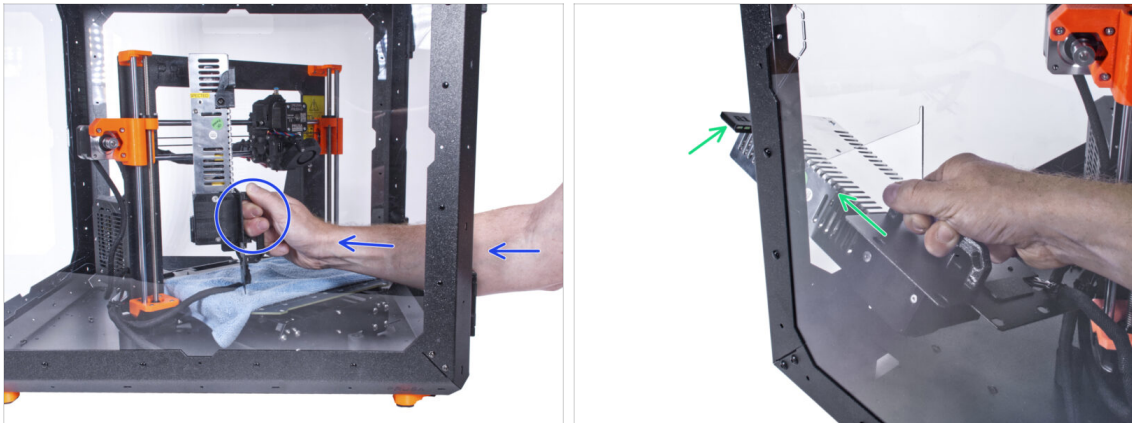

- ◆ From inside the enclosure, grasp the PSU by its handle in your hand.
  - ⓘ It is more convenient to use the right hand.
- ◆ Insert the PSU through the hole at the bottom of the back panel. Start by pushing through the part with the PSU-retainer (the part with the magnets).

## STEP 14 Installing the PSU

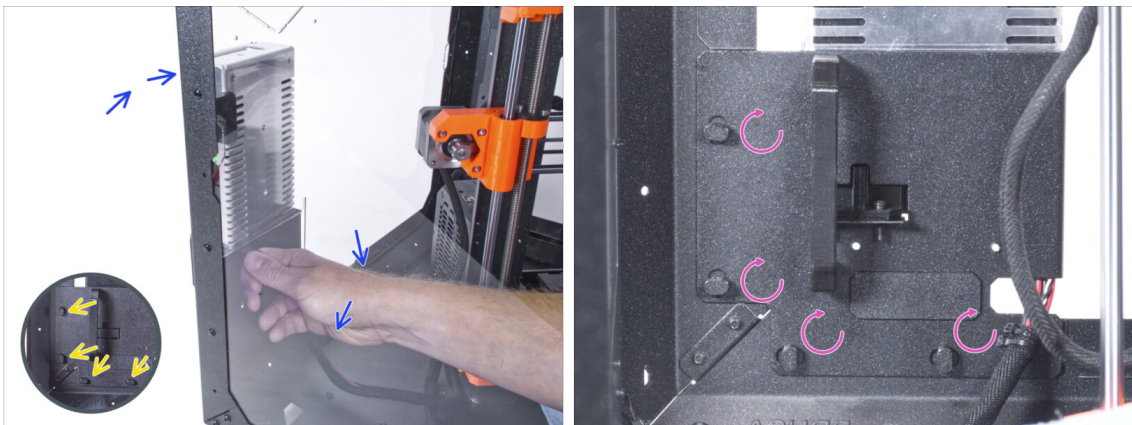

- ◆ Tilt the PSU towards the back panel. The PSU must be outside the enclosure and the PSU holder inside the enclosure.
- ◆ **The PSU holder must fit perfectly on all four PSU-locks.**
- ◆ Turn all PSU-lock 90° to lock the PSU assembly.

## STEP 15 Adjusting the printer

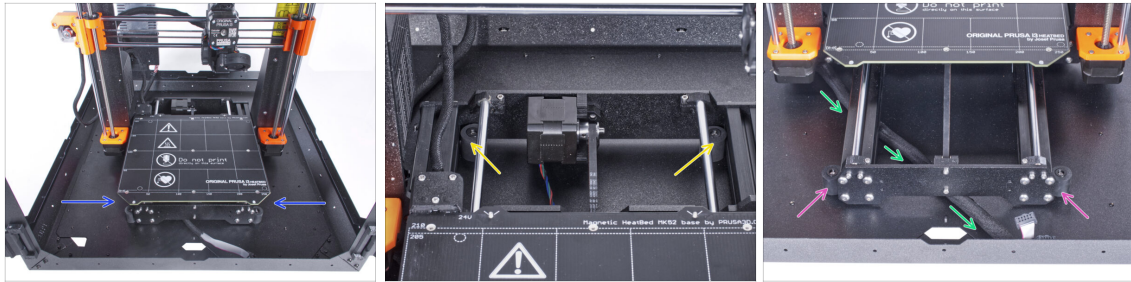

- ◆ Rearrange position of the printer like in the picture. Place it in the center of the enclosure and adjust the correct position:
- The two rear anti-slip dampers must be locked against the rear plate from the inside.
- The two front anti-slip dampers must be locked from the outside by the front plate.
- Guide the LCD cable bundle under the printer from the electronics to the front side of the enclosure. Leave the cable free for now.

## STEP 16 Mounting the LCD: parts preparation



- ◆ **For the following steps, please prepare:**
- LCD assembly (1x)
- M3x8 screw (2x)
- Zip tie (2x)

## STEP 17 Mounting the LCD

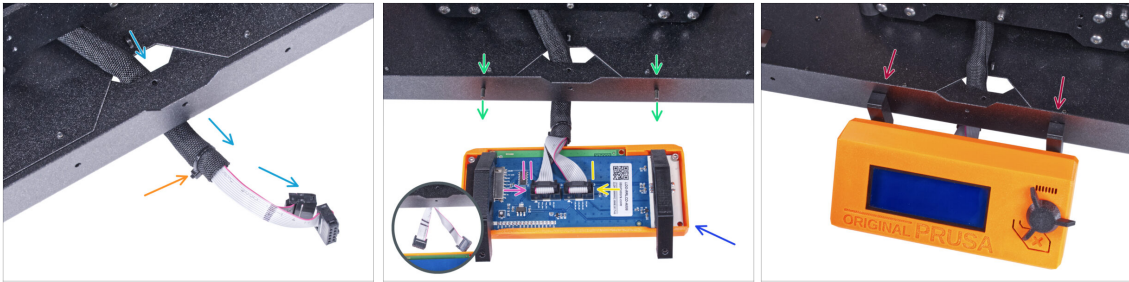

- Guide the LCD cable through the cutout in the bottom panel.
  - Secure the textile sleeve on the cable bundle with the zip tie. **Do not over tighten the zip tie**, it may cut the cables!
  - From the inside, push two M3x8 screws through the bottom profile.
  - Place the LCD assembly close to the LCD cables, like in the picture. Mind the same orientation of the LCD as in the picture. See the LCD-supports for better understanding.
- ⚠ **Note that both cables are marked with stripes on one side. Correct connection order is important!**
- Connect the LCD cable marked with **TWO STRIPES** to the **left slot** (called EXP2) on the LCD controller.
  - Connect the LCD cable marked with **ONE STRIPE** to the **right slot** (called EXP1) on the LCD controller.
  - Slide the LCD assembly onto the two M3x8 screws in the frame and tighten them.

## STEP 18 Securing the LCD cable

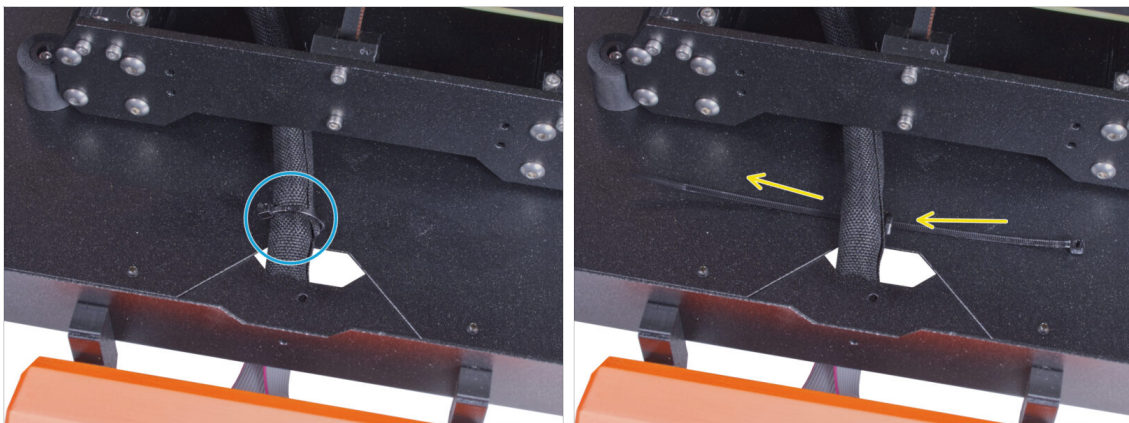

- Guide the zip tie through the perforation in the bottom panel and under the LCD cable bundle.
- Tighten the zip tie to secure the LCD cable bundle. **Do not over tighten the zip tie**, it may cut the cables!

## STEP 19 Assembling the filament guide: parts preparation

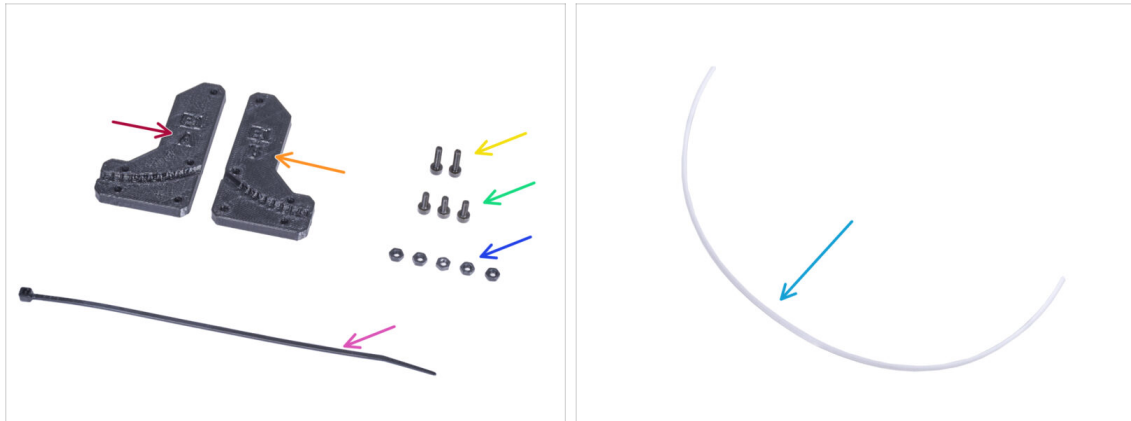

● For the following steps, please prepare:

- Filament-guide-a (1x)
- Filament-guide-b (1x)
- M3n nut (5x)
- M3x12 screw (2x)
- M3x8 screw (3x)
- PTFE tube (1x) 2.5x4x650 mm

## STEP 20 Assembling the filament guide



- Insert five M3n nuts into the Filament-guide-a.
- Attach the Filament-guide-b on the Filament-guide-a part and join them together by three M3x8 screws. **Do not tighten the screws completely**, a few turns are enough for now.
- Slide the PTFE tube all the way into the hole in the filament guide. From the opposite side, **check if the PTFE tube is completely inserted to the end**. If not, slide the PTFE a little more. See the direction of the PTFE tube.

## STEP 21 Mounting the filament guide



- Fully tighten all screws on the filament guide assembly.
- Align the holes in the filament guide and holes in the front-right top corner of the frame. See the orientation of the filament guide.
- Secure the filament guide to the frame with two M3x12 screws.

## STEP 22 Guiding the PTFE tube

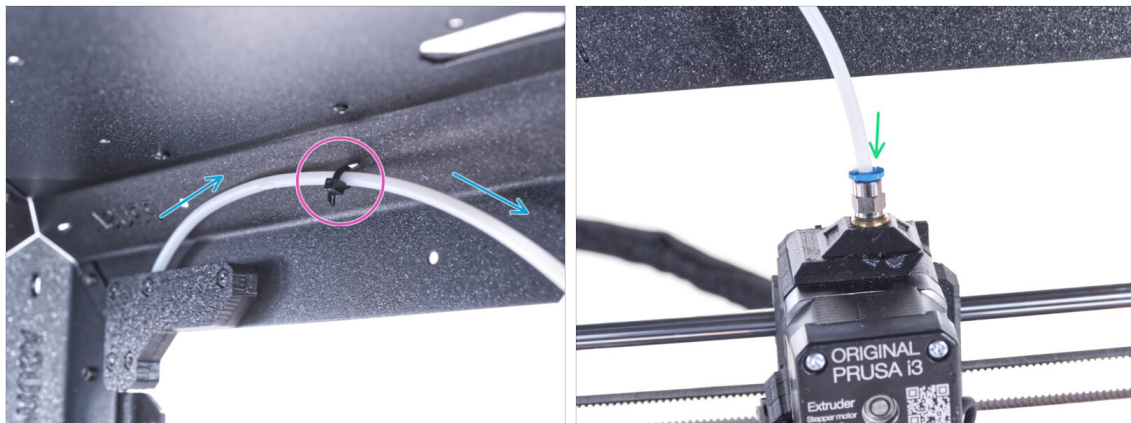

- Guide the PTFE tube to the top frame.
- Secure the tube with the zip tie to the frame.
- Insert the free end of the PTFE tube to the Fitting QSM-M5 on the extruder. Insert it all the way down.



## STEP 23 Assembling the thermometer: parts preparation



◆ For the following steps, please prepare:

- ◆ Temperature sensor (1x)
- ◆ Thermometer-bracket (1x)
- ◆ M3x8 screw (2x)
- ◆ M3n nut (2x)

## STEP 24 Assembling the thermometer



- ◆ Insert two M3n nuts into the Thermometer-bracket.
- ◆ Insert the temperature sensor in the Thermometer-bracket. Push on it by your thumbs until you feel a slight "click". **Avoid pressing on the screen, you can damage it.**
- ◆ From the inside, mount the thermometer to the top left corner. Secure it with two M3x8 screws.

## STEP 25 Assembling doors: parts preparation



For the following steps, please prepare:

- Door panel (2x)
- Door-magnet-a (1x)
- Door-magnet-b (1x)
- Door handle (2x)
- Door trim (2x)

 The list continues in the next step...

## STEP 26 Assembling doors: parts preparation

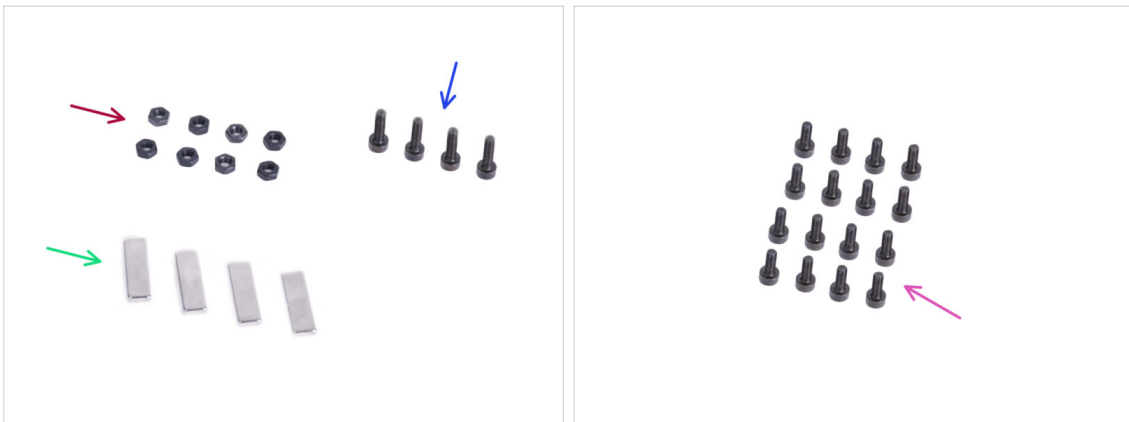

For the following steps, please prepare:

- M3n nut (8x)
- M3x12 screw (4x)
- Magnet 20x6x2 (4x)
- M3x8 screw (16x)

## STEP 27 Assembling the door magnets



- ◆ There is a pocket in each Door-magnet (A and B) part. Place the magnet close to the pocket.
- ◆ Push the magnet all the way into the pocket.
- ◆ Insert two M3n nuts into each Door-magnet (A and B) part.

## STEP 28 Assembling doors



- ◆ Place the edge of the door panel on the door trim. Both sides of the panel are symmetrical. It doesn't matter which side you put it on the door trim. It is important that the circular hole is placed on the door trim.
- ◆ Align the edges of the door panel with both ends of the door trim.
- ◆ Proceed the same with the second door panel.
- ⓘ In the next step, we will need door-magnet-a and door-magnet-b. **These parts are not the same!** Both parts are marked with the letter "A" and "B" and have a different shape.

## STEP 29 Installing the door magnets

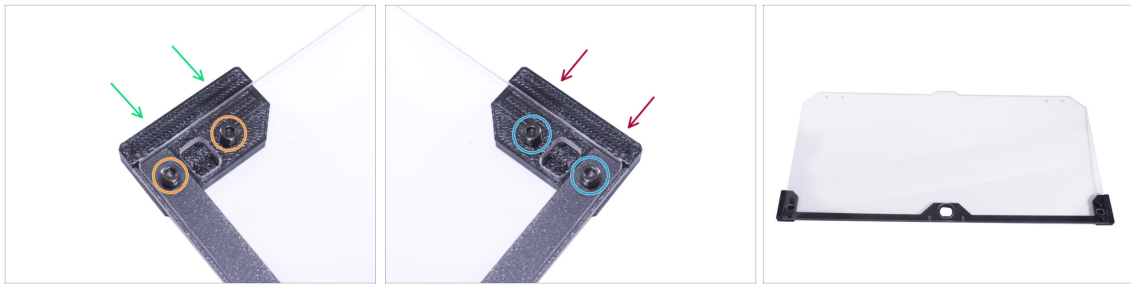

**⚠ Do not overtighten the screws in the door panel! The panel could crack.**

- 🟢 Insert the door-magnet-a under the left side of the door trim and the door panel.
- 🟠 Secure it with two M3x8 screws.
- 🔴 Insert the door-magnet-b under the right side of the door trim and the door panel.
- 🟡 Secure it with two M3x8 screws.
- ⬛ Compare the final look of the panel.
- ⬛ Proceed the same with the second door assembly.

## STEP 30 Mounting the door handles

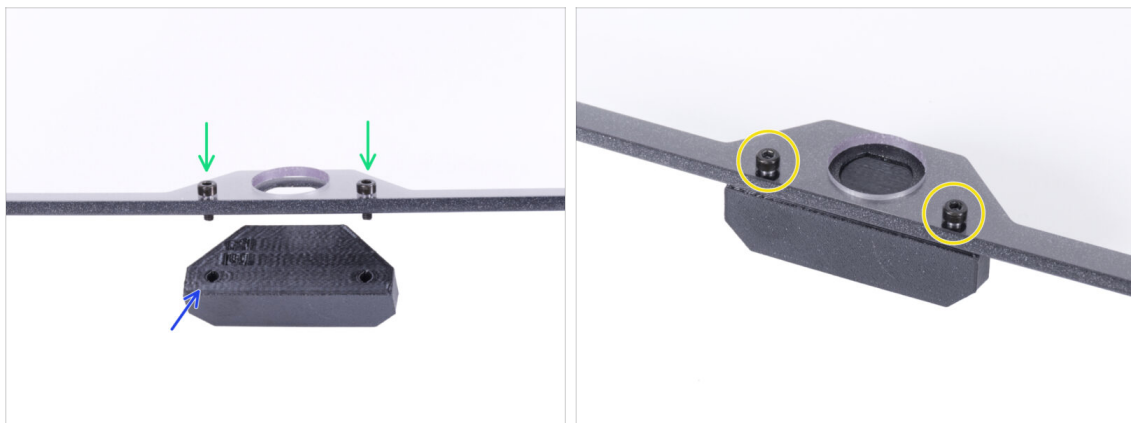

**⚠ Do not overtighten the screws in the door panel! The panel could crack.**

- 🟢 Insert two M3x12 screws through the holes in the door assembly. In the picture, **notice from which side the screws are inserted.**
- 🟡 Place the Door-handle under the door assembly and align the holes with the screws.
- 🟠 Join the parts together by tightening the M3x12 screws.
- ⬛ Proceed the same with the second door assembly.

## STEP 31 Installing the door

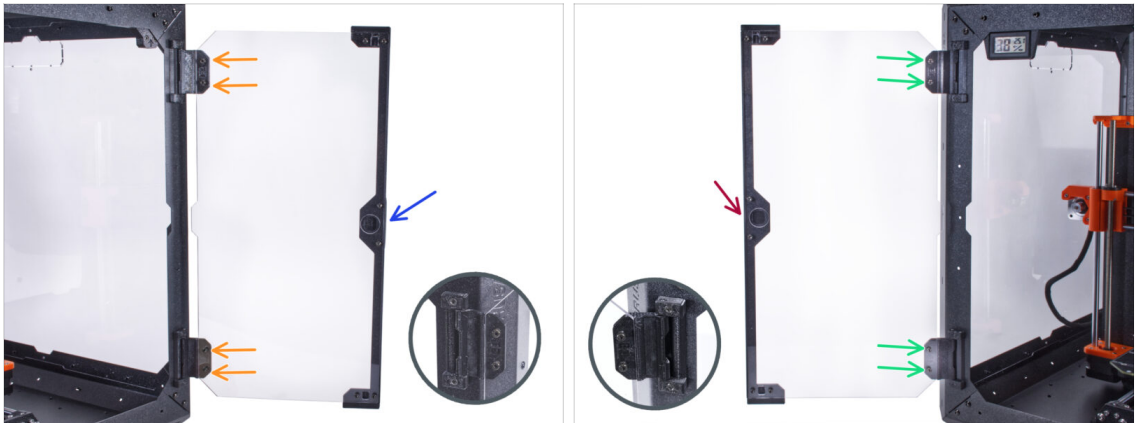

**⚠ Do not overtighten the screws in the door panel! The panel could crack.**

- ◆ Take one of the door assemblies and place it on the open hinges on the right side of the enclosure. **Make sure the handle is on the outside of the panel.**
- ◆ Secure the door assembly by tightening two M3x8 screws in each hinge.
  - i Look at the detail for a better illustration of how the door panel is attached to the hinge.
- ◆ Take the second door assembly and place it on the open hinges on the left side of the enclosure. **Make sure the handle is on the outside of the panel.**
- ◆ Secure the door assembly by tightening two M3x8 screws in each hinge.

## STEP 32 Installing the top plugs

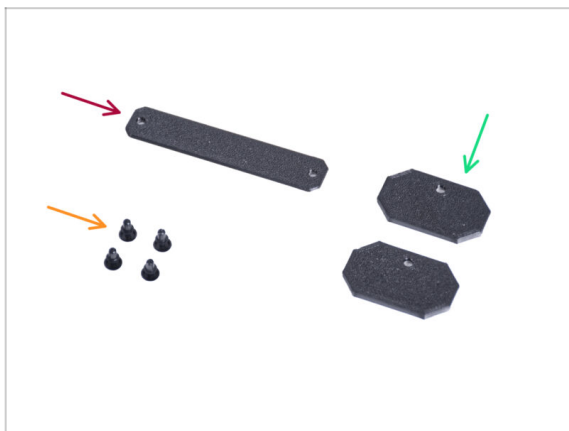

- ◆ **For the following steps, please prepare:**
- ◆ Top-plug-center (1x)
- ◆ Top-plug-edge (2x)
- ◆ Nylon rivet (4x)

### STEP 33 Installing the top plugs

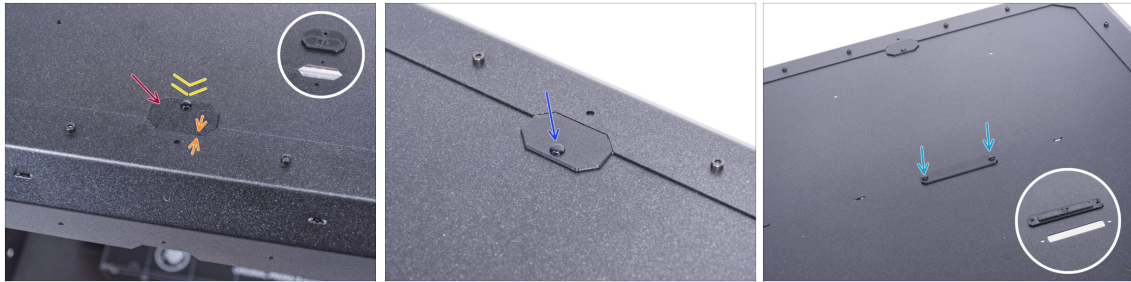

- Insert the Top-plug-edge to the cutout in the front of the top panel.
- The top surface of the printed part must be flushed with the top surface of the profile.
- Secure it with the nylon rivet.
- Install the second Top-plug-edge to the same cutout on the rear side of the top panel. Secure it with the nylon rivet.
- Insert the Top-plug-center in the rectangular cutout in the center of the top panel. Secure it with two nylon rivets.

### STEP 34 Removing the side arm



- Take the spool holder that you remove from the printer.
- Turn one arm counterclockwise to release it from the spool holder.

## STEP 35 Installing spool holder: parts preparation

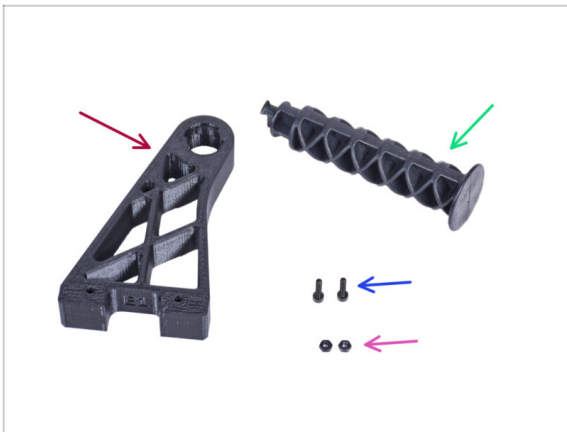

◆ For the following steps, please prepare:

- ◆ Spool-holder-r (1x)
- ◆ Side arm (1x)
- ◆ M3x12 screw (2x)
- ◆ M3n nut (2x)

## STEP 36 Installing spool holder



- ◆ Completely insert two M3n nuts into the holes in the Spool-holder-r.
- ◆ From the inside, attach the Spool-holder-r to the corner on the right side of the enclosure. Secure it with two M3x12 screws. See the orientation of the Spool-holder-r.
- ◆ Insert the side arm into the Spool-holder-r and turn clockwise to lock it.

## STEP 37 Transport handle (optional): parts preparation



**i** Some of the following steps are marked as optional. If you do not need to install the handles at this time, skip to **Reward yourself!**

**■** For the following steps, please prepare:

- Transport-handle (2x) *this part is not included in the package, you will need to print it out*
- M3nS nut (6x)
- M3x12 screw (6x)

## STEP 38 Installing the transport handle (optional)



- Insert two M3nS nuts from the side into each Transport-handle.
- Insert the M3nS nut from the other side into each Transport-handle.
- Using the knife, CAREFULLY cut off all supports of each handle cutout on the side panels and remove it.



## STEP 39 Installing the transport handle (optional)



- ✦ From the inside of the enclosure, push on the nylon rivets using the pliers. And pull them out from the outside.
- ✦ From the inside, place the Transport-handle into the same shape cutout.
- ✦ Secure it with three M3x12 screws.
- ✦ Repeat the same procedure for the second Transport-handle.

## STEP 40 Reward yourself!



- ✦ Wasn't it difficult? Of course not. We hope you enjoyed the assembling. **Don't forget to reward yourself.**
- ✦ Eat the remaining gummy bears.

## STEP 41 That's it!

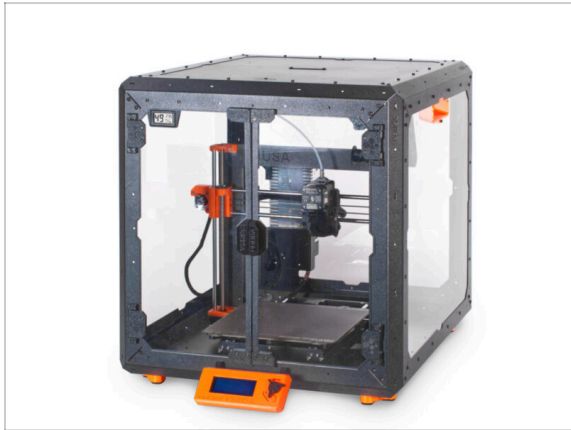

- **Before you start printing with the printer in the enclosure, do the following:**
  - **Perform XYZ axis calibration.** On the printer screen, navigate to *Calibration* -> *Calibrate XYZ* and follow the instructions on the display.
  - **Calibrate the first layer** by following the procedure in this article: [First Layer Calibration \(i3\)](#).
- **Well done! You just successfully assembled the Original Prusa Enclosure.**
- ⚠ **IMPORTANT:** Before you start using the enclosure, read the user guide shipped in your package and read the article about how to care of the side panels.

## STEP 42 Enclosure add-ons

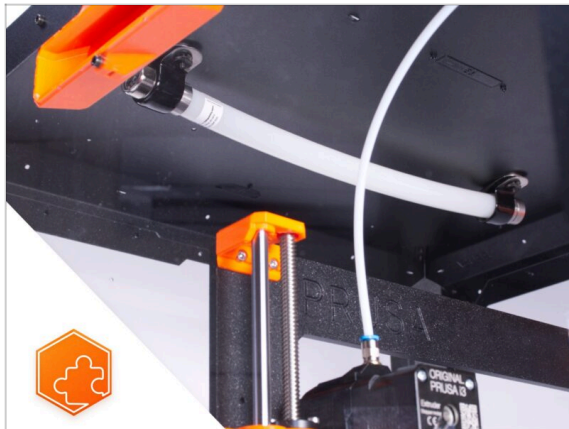

- List of available guides for Enclosure add-ons:
  - [Fire Suppression System](#)
  - [Hinged Lid](#)
  - [Advanced filtration system](#)
  - [Mechanical lock](#)
  - [White LED strip](#)

## Manual changelog Enclosure kit

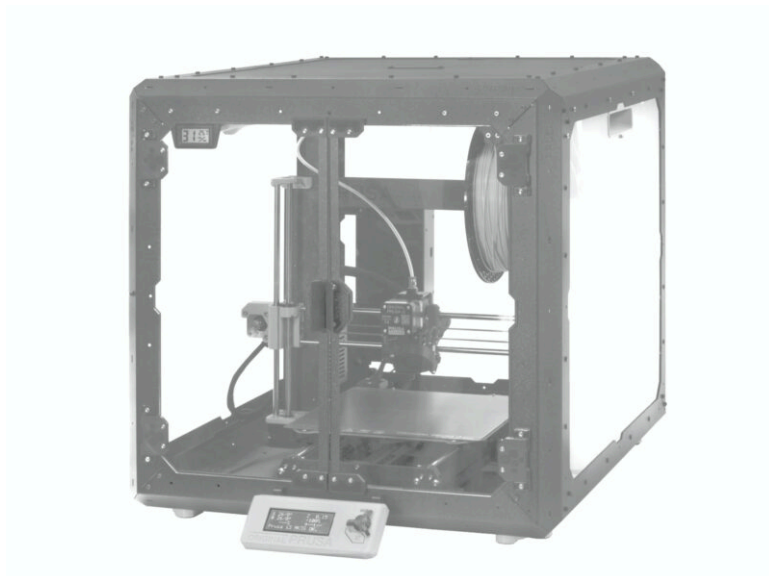

## STEP 1 Versions history

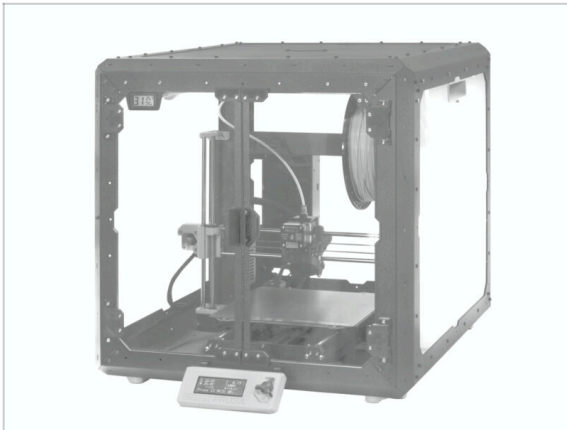

- ◆ **Versions of the Original Prusa Enclosure manual:**
- ◆ 08/2022 - Initial version 1.00
- ◆ 09/2022 - Updated to version 1.01
- ◆ 10/2022 - Updated to version 1.02
- ◆ 11/2022 - Updated to version 1.03
- ◆ 05/2024 - Updated to version 1.1

## STEP 2 Changes to the manual (1)

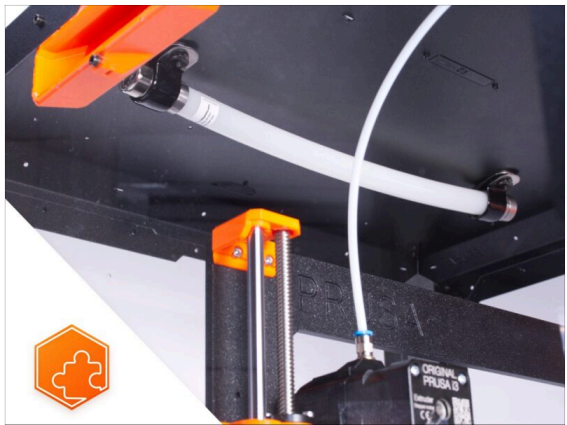
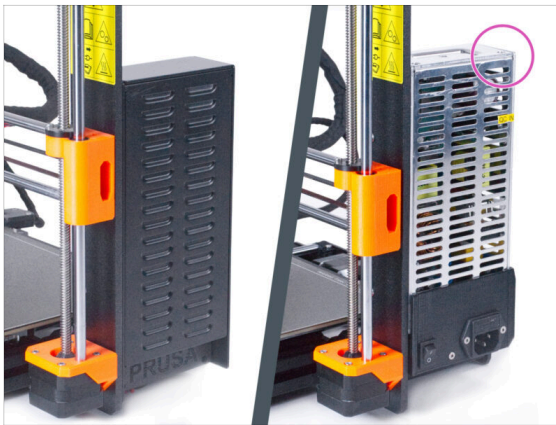

- ◆ 09/2022 - Silver PSU installation.
  - ◆ Added the Silver PSU installation instructions. Subsequently, necessary changes across the entire manual.
- ◆ 09/2022 - New add-ons
  - ◆ **Fire Suppression System**
  - ◆ **Hinged Lid**
- ① Manual version 1.01

### STEP 3 Changes to the manual (2)



- 10/2022 - New add-ons
  - Advanced filtration system
  - Mechanical lock
  - Quick release PSU cable - MK3S+ Black PSU
  - White LED strip
- ① Manual version 1.02

### STEP 4 Changes to the manual (3)

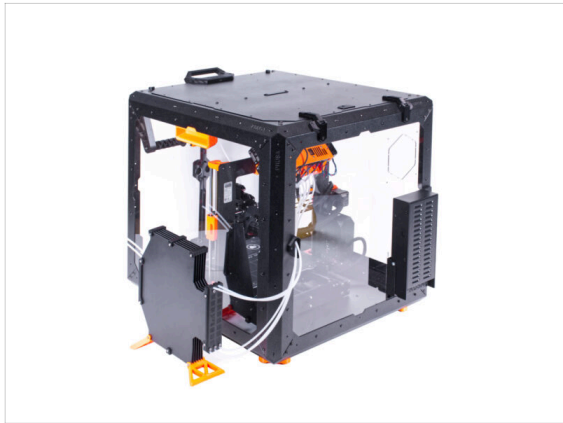
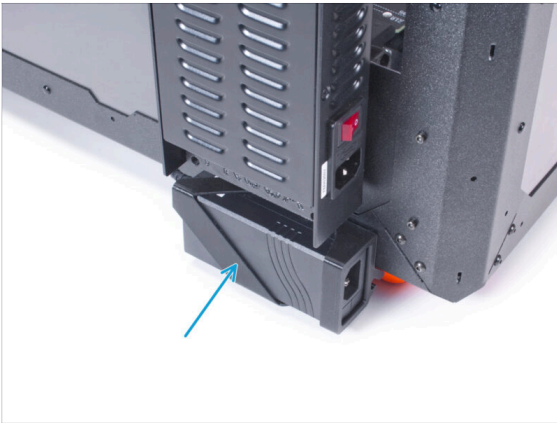

- 11/2022 - Add-ons
  - Added instructions for installing an external XP Power PSU for the White LED strip and Advanced filtration system add-ons.
  - The Hinged Lid add-on manual now includes mounting the MMU.
- ① Manual version 1.03

## STEP 5 Changes to the manual (4)

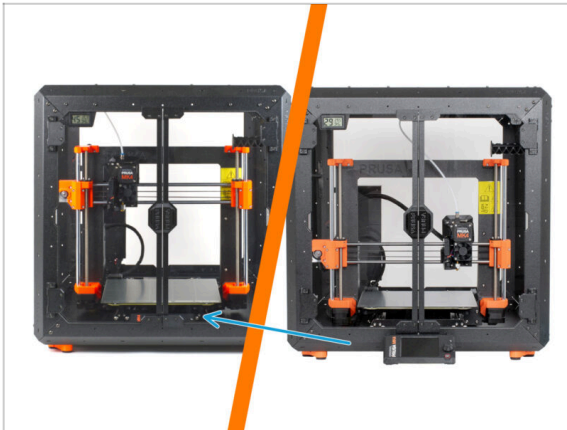

- 05/2024 - applies to MK4, MK3.9, MK3S+ installation
- As of the end of May 2024, parts for mounting the display outside the enclosure are no longer included. Therefore, the display now remains on the printer inside the enclosure.
- A completely new procedure has been created for this [Original Prusa Enclosure \(with display inside\)](#) assembly manual.
- Manual version 1.1

## 5. Fire Suppression System (add-on)

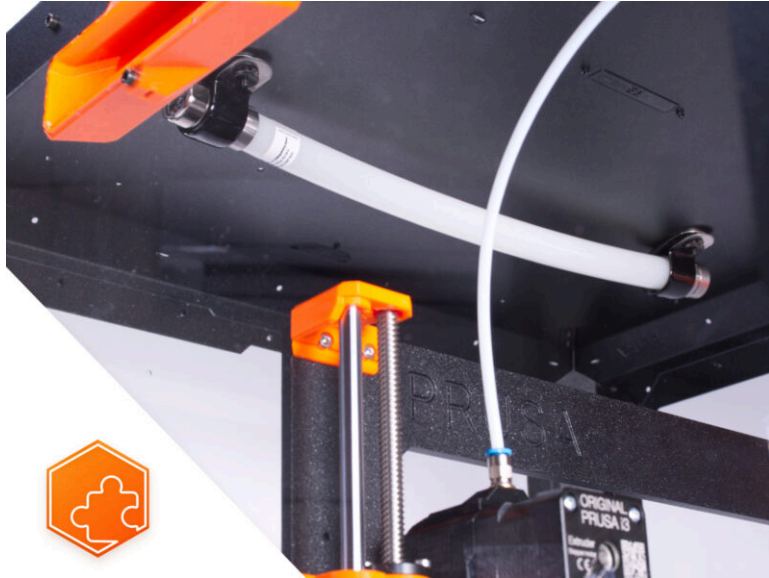

## STEP 1 Introduction

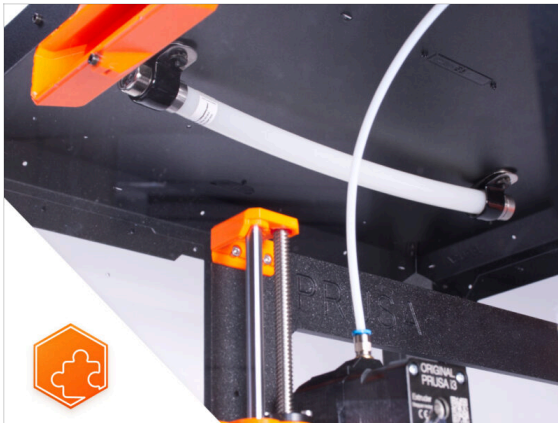

- This guide will take you through the installation of the **Fire Suppression System** into the **Original Prusa Enclosure**.

## STEP 2 Tools necessary for this guide

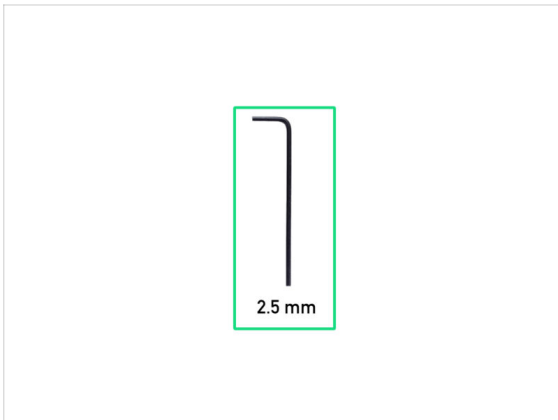





- **For this guide, please prepare:**
- 2.5mm Allen key
- Piece of cloth or fabric (at least 20x20 cm) *for covering the heated bed*

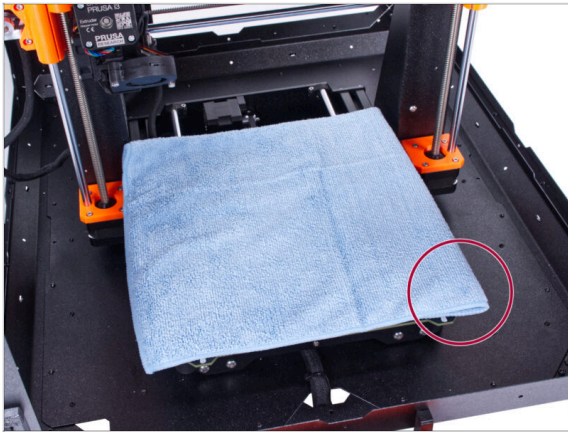





### STEP 3 Preparing the printer



-  **Make sure the printer is turned OFF and cool down!**
-  **Before you proceed, it is recommended to protect the heatbed.**
-  Take off the flexible steel sheet.
-  Use any cloth or piece of fabric, which is thick enough and cover the heatbed. This will ensure you won't damage (scratch) the surface during the disassembly.

### STEP 4 Parts preparation:



-  **For the following steps, please prepare:**
-  P-clamp (2x)
-  M3 nut assembly (2x) *the nut with the M3x12 screw*
-  Fire suppression system tube (1x) *type: T033E BlazeCut T Series Fire Suppression 1 System with a pressure gauge*
-  **Handle the tube carefully to avoid damage.**

## STEP 5 Mounting the P-clamp



- ◆ Unscrew both M3x12 screws from the nuts.
- ◆ Locate two holes (the two farther apart) on the rear side of the top panel and insert the M3x12 screws into both holes.

## STEP 6 Mounting the P-clamp

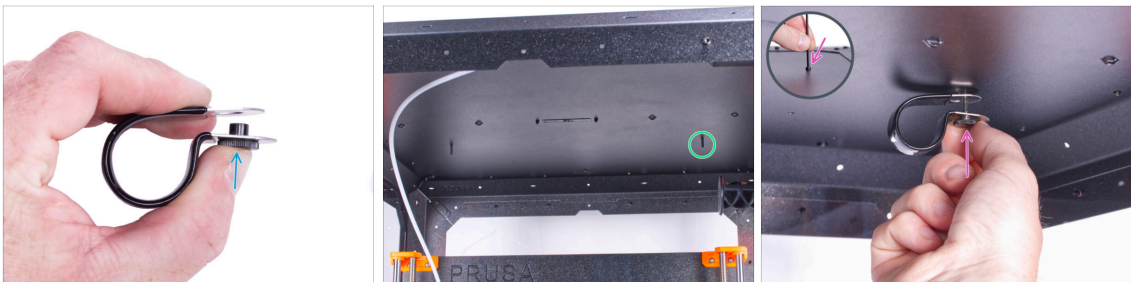

- ◆ From the inside, locate the inserted M3x12 screws on the right side of the top panel.
- ◆ Insert the nut into the P-clamp. See the correct orientation of both parts.
- ◆ Attach the nut in the P-clamp to the M3x12 screw in the top panel. Tighten the screw using the Allen key from the top with your other hand. **Do not tighten the screw now!** A few turns are enough. We will tighten it later.

## STEP 7 Installing the automatic suppression system



- ◆ Insert the metal end of the tube into the P-clamp.
  - ⓘ If it is difficult to insert the tube into the P-clamp, loosen the nut a little. **But be careful not to drop the P-clamp!**
- ◆ Make sure the nut is accessible from the front.
- ◆ From the other side of the tube, slide the second P-clamp on the metal part of the tube. Mind the correct position of the P-clamp.
- ◆ Insert the nut into the P-clamp and attach it to the M3x12 screw on the left. Slightly tighten the screw using the Allen key from the top with your other hand - a few turns are enough for now. We will completely tighten it later.

## STEP 8 Securing the automatic suppression system



- ◆ Align the tube in the P-clamps. There should be an equal piece of tube section protruding out on each side.
- ◆ Fully tighten the P-clamps.

**STEP 9** That's it!

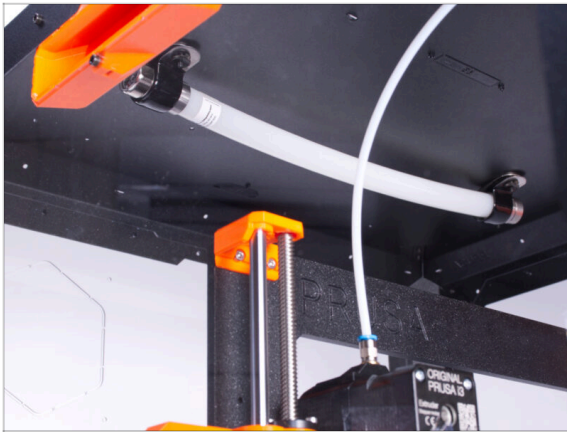

- ◆ **Congratulations!** You just successfully installed the Fire Suppression System.

## 6. Hinged Lid (add-on)



## STEP 1 Introduction



- This guide will take you through the installation of the **Hinged lid** on the **Original Prusa Enclosure**.
- **Before you start installing the add-on, PRINT OUT ALL NECESSARY PLASTIC PARTS!** The parts are available for download at [Printables.com](https://www.printables.com).
- ⓘ All necessary fasteners are already included in the Enclosure kit.

## STEP 2 Tools necessary for this chapter

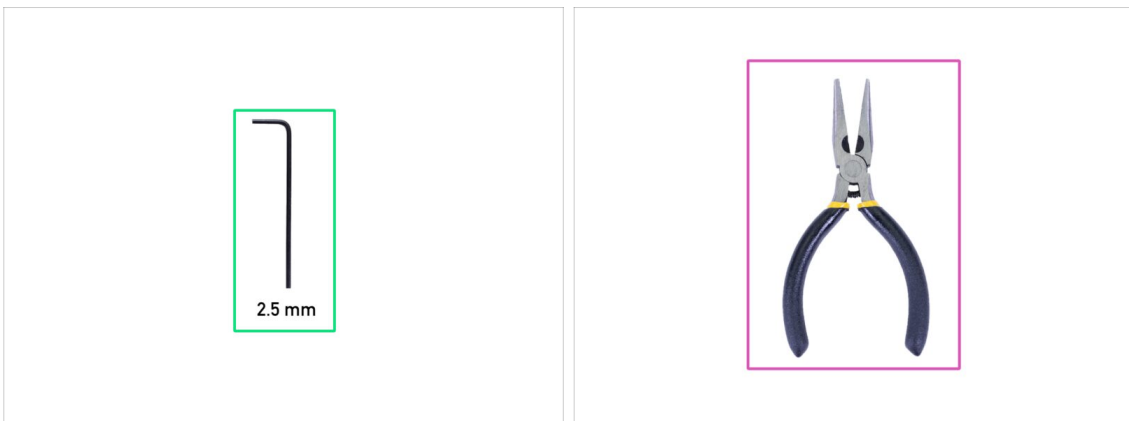

- **For this chapter, please prepare:**
- 2.5mm Allen key
- Needle-nose pliers
- Pocket knife or snap-off knife (*for MMU installation only*)

**STEP 3** Removing the covers

- From inside, push out the nylon rivet securing the Top-plug-edge in the front of the enclosure. Use the needle-nose pliers to push on the nylon rivet.
- Remove the Top-plug-edge part from the enclosure.
- Using the same procedure remove the Top-plug-edge on the rear side.
- Remove the Top-plug-center part. **Do not discard this part**, you will need it later again.

**STEP 4** Removing the top panel

- Release thirteen screws on the top frame.
- Keep the three screws in the positions marked in the picture.
- From inside, support the top panel with your hand.
- Using the other hand release the three screws securing the top panel while holding the panel.
- ⚠ **WARNING: Be careful not to drop the top panel and cause injury or damage!**
- Push out the top panel through the top frame opening and remove it from the enclosure.

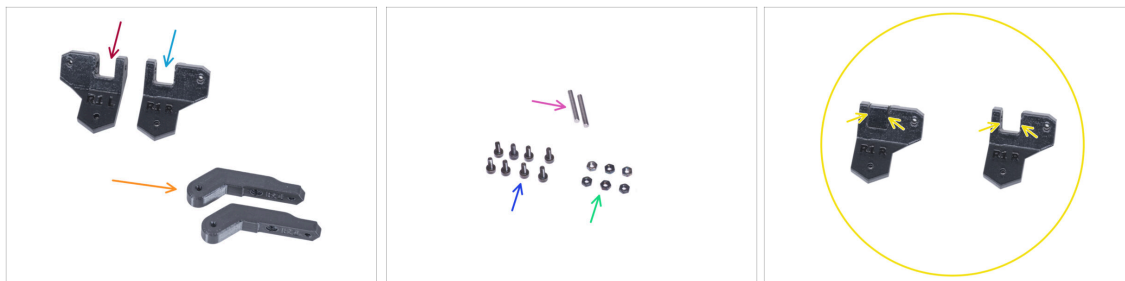
**STEP 5** Installing the lid hinges: parts preparation

For the following steps, please prepare:

- Hinge-bracket-L (1x)
- Hinge-bracket-R (1x)
  - Note that, after printing, both the hinge brackets have an internal support structure which needs to be removed before use. See the last picture.
- Hinge-lever (2x)
- Pin 3x20 (2x)
- M3x8 screw (8x)
- M3n nut (6x)

**STEP 6** Assembling the lid hinges

- Insert the Hinge-lever into the Hinge-bracket-R.
- Align the holes in both parts and push the pin 3 x 20 into the plastic parts.
- Against the flat surface, push the pin all the way into the plastic parts. Make sure the pin is flush with the surface of the part.
- Proceed the same for the Hinge-bracket-L.



## STEP 7 Assembling the lid hinges



- Insert three M3n nuts into each hinge assembly.

## STEP 8 Installing the lid hinges

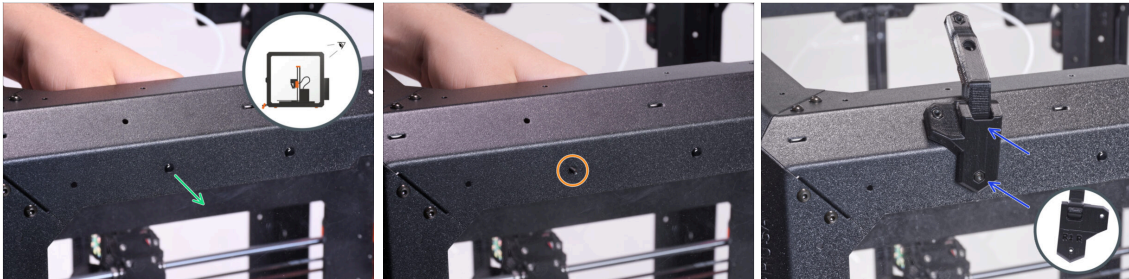

**!** If you have installed the Advanced filtration system add-on, use the hinge-bracket-Rt available on [printables.com](https://printables.com)

- Turn the enclosure with the rear side facing you. And focus on the left top corner.
- From inside, push out the first nylon rivet from the left.
- i** Use the needle-nose pliers to push on the nylon rivet.
- Into the same hole, insert the M3x8 screw from the inside.
- Attach the Hinge-bracket-R assembly to the screw and tighten it.

### STEP 9 Installing the lid hinges

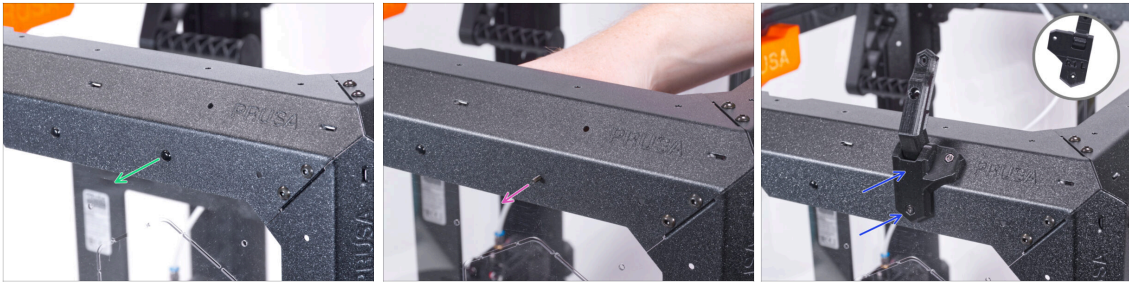

- Focus on the right top corner on the rear side of the enclosure.
- From inside, push out the first nylon rivet from the right.
- ⓘ Use the needle-nose pliers to push on the nylon rivet.
- Into the same hole, insert the M3x8 screw from inside.
- Attach the Hinge-bracket-L assembly to the screw and tighten it.

### STEP 10 Installing the lid hinges



- Secure the Hinge-bracket-L with the M3x8 screw from the inside.
- Secure the Hinge-bracket-R with the M3x8 screw from the inside.
- Open both hinges.

## STEP 11 Installing the top panel

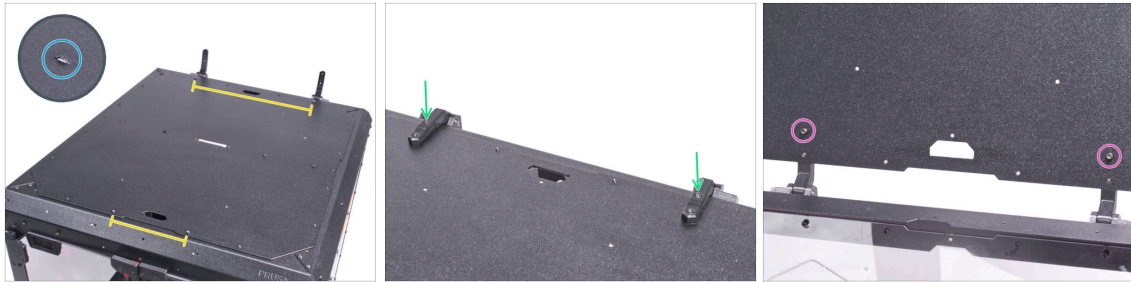

- **Place the top panel on the top of the enclosure and make sure that:**
  - Perforations on the top panel are facing up.
  - The side with the more distant threaded columns is at the rear (close to the hinges).
- Close the hinges and secure each hinge with the M3x8 screw.
- Open the lid (top panel) and secure each hinge with the M3x8 screw from the underside.

## STEP 12 Installing the covers: parts preparation

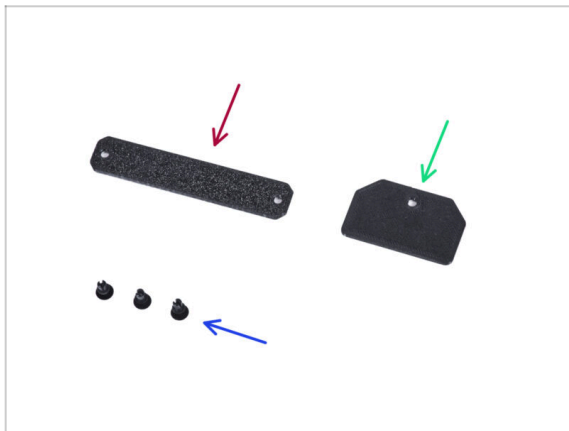

- **For the following steps, please prepare:**
  - Top-plug-center (1x) *re-use the old part*
  - Top-plug-rear(1x)
  - Nylon rivet (3x)

### STEP 13 Installing the covers



- Place the Top-plug-center on the rectangular hole in the top panel and secure it with two nylon rivets.
- Place the Top-plug-rear to the cutout on the rear side of the top panel and secure it with the nylon rivet.

### STEP 14 Mounting the handle: parts preparation



- For the following steps, please prepare:
- Lid-handle (1x)
- M3x8 screw (3x)
- M3nS nut (1x)

## STEP 15 Mounting the handle



- Insert the M3nS nut all the way into the Lid-handle.
- Attach the Lid-handle to the top panel on the front edge and secure it with two M3x8 screws.
- ⚠ **Do not overtighten the screws! It can damage the thread in the metal sheet.**
- Open the lid and secure the handle from inside using the third M3x8 screw.

## STEP 16 Mounting the locks: parts preparation



- **For the following steps, please prepare:**
- M3x8 screw (2x)
- Lid-lock (2x)

## STEP 17 Mounting the locks

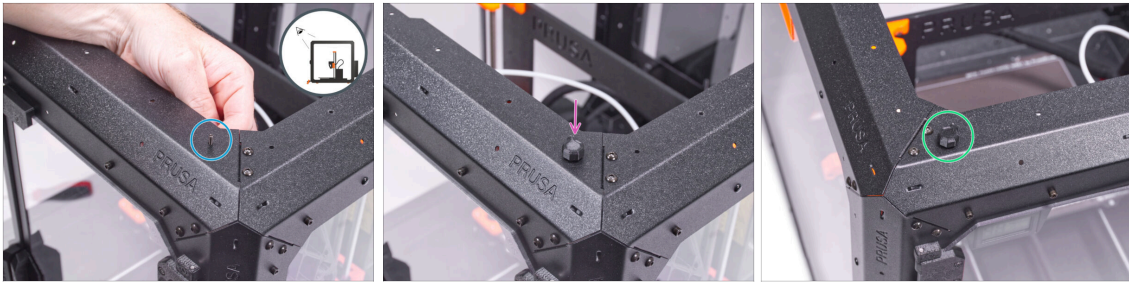

- Turn the enclosure with the front side facing you and focus on the right top corner.
- From inside, insert one M3x8 screw through the first hole from the left on the top front profile.
- Attach one of the Lid-lock to the screw and tighten it. Do not over tighten the screw. The lock must rotate freely.
- Proceed the same with the second Lid-lock.

## STEP 18 Locking the locks

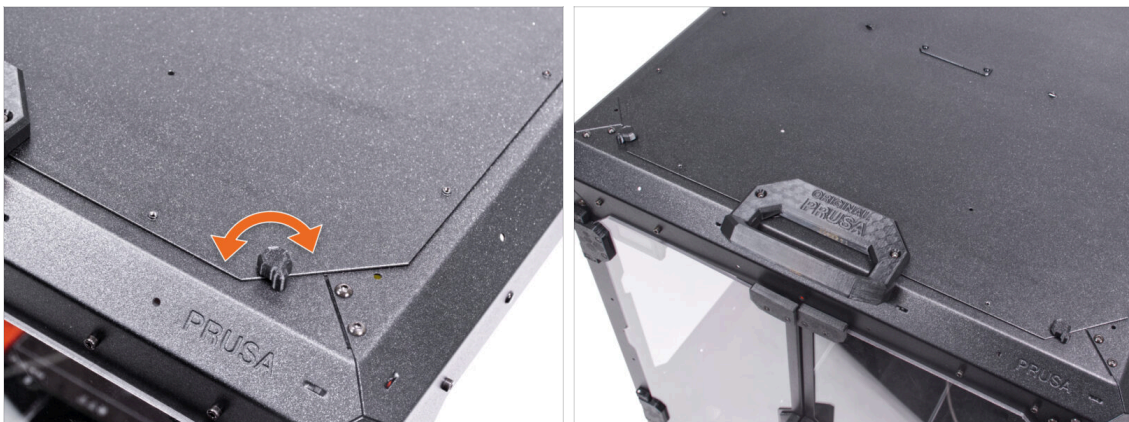

- Close the lid and turn both Lid-lock. If the locks turn stiffly over the lid, slightly loosen the screws on the bottom of the lock (inside the enclosure).

## STEP 19 MMU Installation

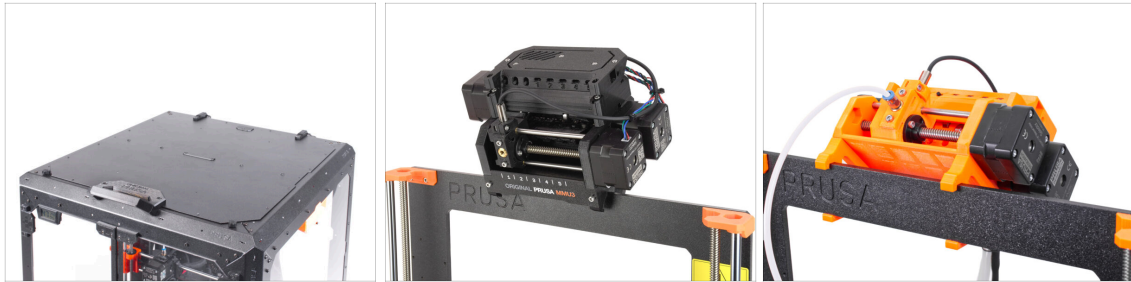

- **Great job!** You've successfully installed the hinged lid. If you're using a single-material printer, your work is complete.
- For installing the **MMU3** into the Original Prusa Enclosure, continue with the following guide:
  - **6A. Hinged Lid with MMU3**
- For installing the **MMU2S** into the Original Prusa Enclosure, continue with the following guide:
  - **6B. Hinged Lid with MMU2S**

## 6A. Hinged Lid with MMU3

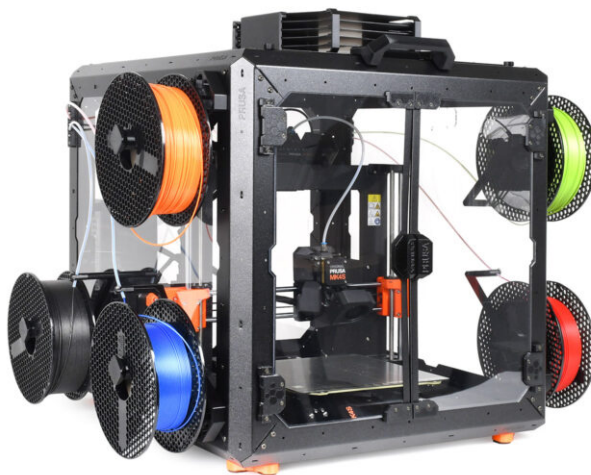



## STEP 1 Introduction



◆ This chapter guides you through the installation of the MMU3 into the Enclosure.

◆ The MMU3 can only be installed after the **Hinged Lid** is in place.

⚠ Since the **MMU3 is compatible with multiple printer models**, note that some parts of your printer **may slightly differ from the pictures**. However, the assembly process remains the same.

## STEP 2 Printable parts

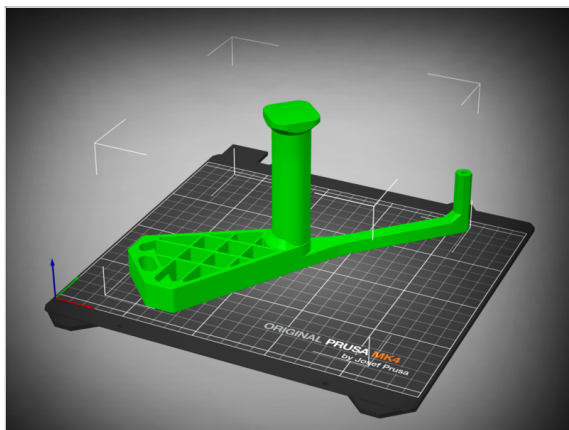

◆ If you didn't receive the printable parts in your package, you can download them from Printables.com and print them.

◆ <https://www.printables.com/model/980267-mm3-enclosure-addon>

◆ However, to complete the installation, you'll also need to obtain a package of additional hardware, including screws, nuts, long PTFE tubes, and magnets.

ⓘ The necessary components are available **ONLY** in the MK4S + MMU3 + Enclosure Bundle.

### STEP 3 LCD Removal

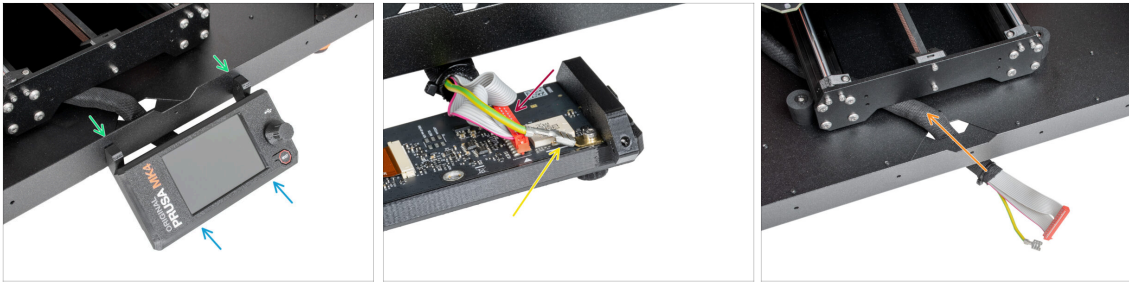

◆ If you have the LCD mounted on the enclosure, follow these steps:

- ◆ From the inside, remove the two screws holding the LCD
- ◆ Disconnect the LCD cable / cables.
- ◆ On MK4/S, disconnect also the grounding connector.
- ◆ Move the cable bundle to the inside of the enclosure.

### STEP 4 Spool Holder Removal



- ◆ Remove the two screws on the right side of the Enclosure, holding the spool holder.
- ◆ Remove the spool holder.

## STEP 5 Filament Guide Removal



- ◆ Press down the collet on the filament fitting on the extruder.
- ◆ While keeping the collet pressed, pull the PTFE tube out of the fitting.
- ◆ Cut the zip tie securing the PTFE tube on the inner side of the top front profile.
- ◆ Remove the two screws securing the filament guide and take it out of the enclosure.

## STEP 6 PSU Removal

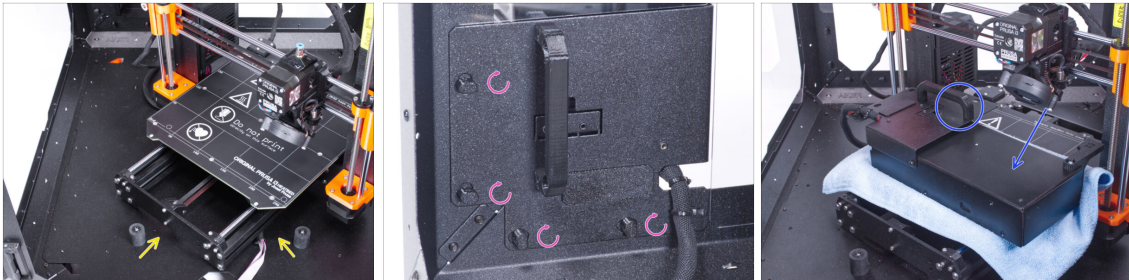

- ◆ Place the printer at an angle (as shown) inside the enclosure, positioning it behind the anti-slip dampers.
- ◆ Unlock all PSU locks, then grasp the handle and remove the PSU assembly from the back panel.
- ◆ Place the PSU on the heatbed, protected by a cloth, with the PSU handle facing upwards.

## STEP 7 Printer Removal

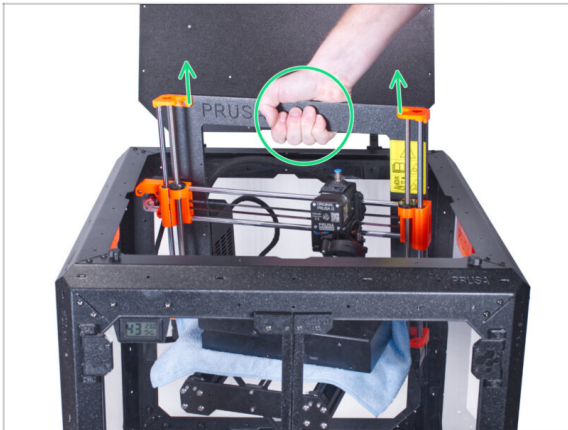

- Open the top lid.
- Grasp the printer by its frame and carefully lift it out of the enclosure.
- ⚠ Avoid scratching the printer and enclosure.

## STEP 8 MMU3 Installation

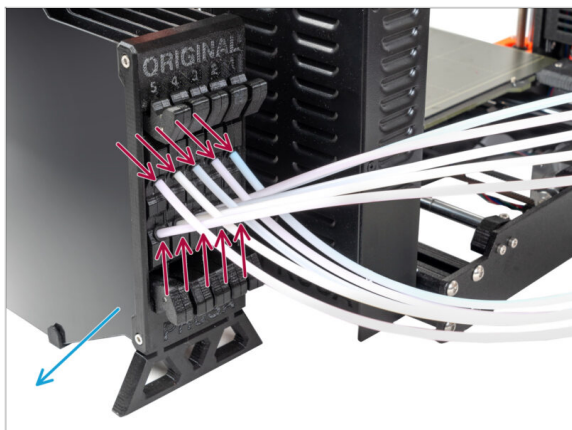

- ⚠ If you are installing a new MMU3 unit onto the printer:
  - If necessary, re-connect the LCD to the printer so that it's functional again.
  - Continue to the [MMU3 Assembly guide](#)
  - ⓘ Once you've installed the MMU3 unit on the printer, test it. Afterward, return to this guide and proceed with the next step.
- If you have temporarily disconnected the MMU3 unit from the printer during the enclosure assembly, continue to the next step.

**STEP 9** Buffer Removal

- ◆ Disconnect **ALL PTFE tubes** from the buffer.
- ◆ Move the buffer away from the printer.
- ⚠ In the following steps, we will prepare the Enclosure and modify the Buffer before installing them into the Enclosure.

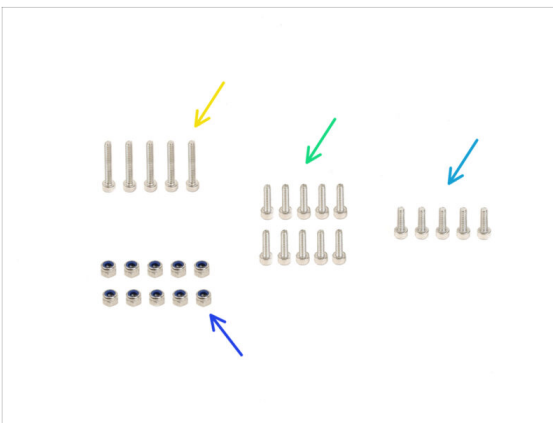
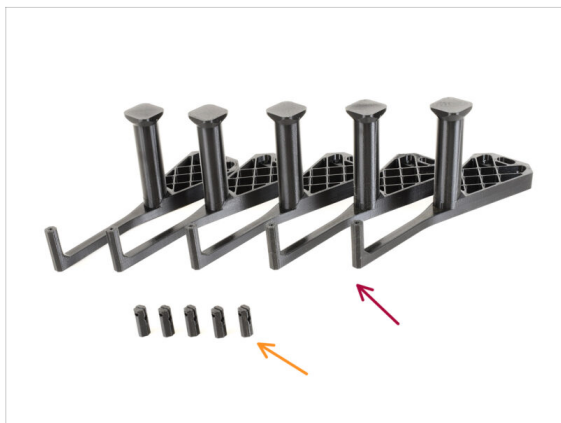
**STEP 10** Spool Holders: Parts preparation

- For the following steps, please prepare:
- ◆ mmu\_enclosure\_spoolholder (5x)
- ◆ mmu\_enclosure\_spoolholder\_R3\_cap (5x)
- ◆ M3x20 screw (5x)
- ◆ M3x12 screw (10x)
- ◆ M3x10 screw (5x)
- ◆ M3nN nut (10x)

## STEP 11 Spool Holders Preparation 1

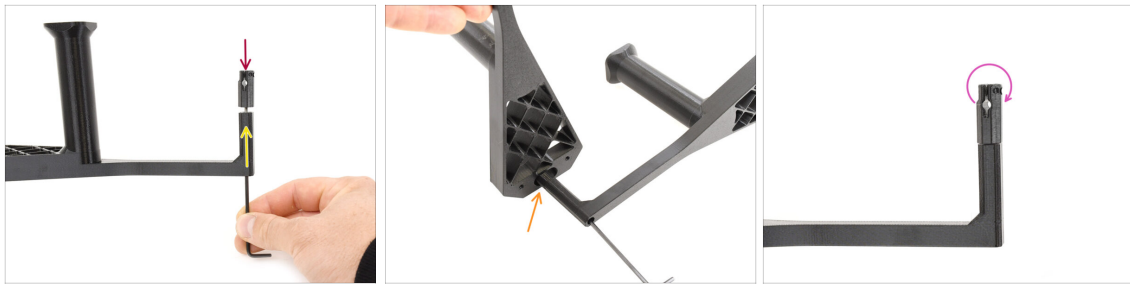

- ◆ Take one spool holder. Add the **Cap** part onto the small tubular part of the spool holder.
- ◆ Insert the **M3x20** screw through the tubular part and tighten it against the Cap. Ensure it's tight enough to hold the Cap in place, but still **allows it to rotate**.
  - ◆ Pro tip: If it's hard to turn, you can use one of the other spool holders as a handle for the cap part.
  - ◆ Do not tighten the M3x20 screw fully. The cap must be able to rotate freely.

## STEP 12 Spool Holders Preparation 2



- ◆ Add the **M3x10** screw onto the end of the Cap. Just start the thread. **Do not tighten it up yet!**
- ◆ Install the two **M3nN** nuts into the openings on the Spool holder. Push them all the way in.
- ◆ Repeat the same process until you assemble all **five spool holders**.

## STEP 13 Spool Holders Installation 1

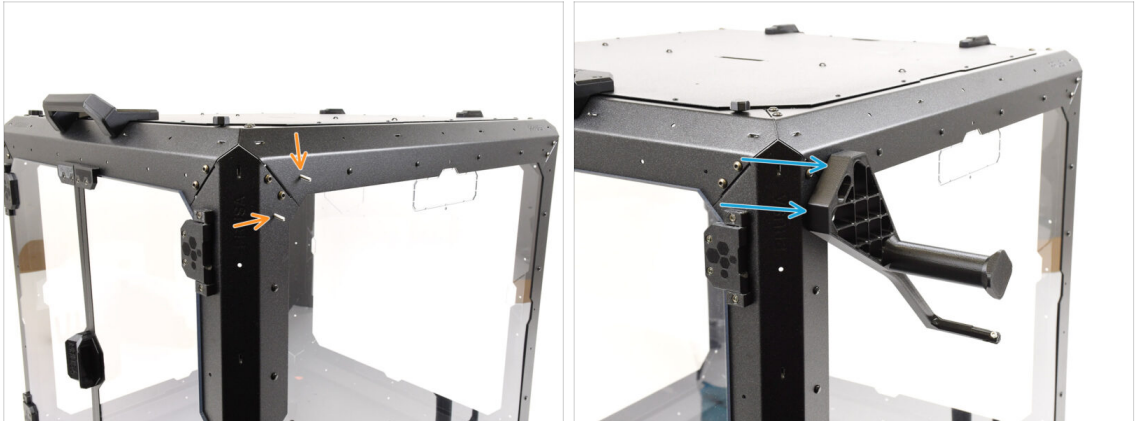

- Now, let's move on to the right side of the enclosure.
- Run two **M3x12** screws through the marked openings, from the inside to the outside.
- Mount the first spool holder onto the screws. Tighten the screws fully.

## STEP 14 Spool Holders Installation 2



- Using two **M3x12** screws, attach a second spool holder into the bottom front corner.
- Using the same technique, mount the remaining three spool holders onto the **LEFT** side of the enclosure in the marked positions.
- Verify that the spool holders are positioned as shown in the picture.

## STEP 15 Internal Lock parts preparation

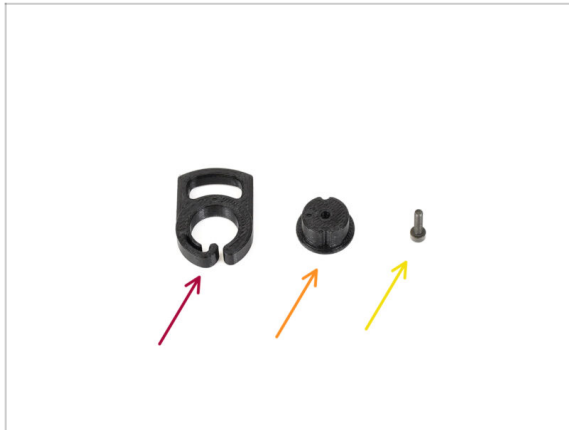

◆ For the following steps, please prepare:

- ◆ Internal Lock A (1x)
- ◆ Internal Lock B (1x)
- ◆ M3x12 screw black (1x)

## STEP 16 Internal Lock Preparation



- ◆ Insert the **M3x12** screw through the Lock B part.
- ◆ Orient **Lock B** with the screw pointing upwards and the small **protruding part** being on the left.
- ◆ Orient **Lock A** so that the circular opening is on the left.
  - ◆ The **protruding circular part** must be pointing up.
- ◆ Fit the two parts together, ensuring they align properly.



## STEP 17 Internal Lock Installation



- ◆ Open the top lid and remove the screw on the inside that secures the handle.
- ◆ Orient the lock so that the **small protruding part** aligns with the opening in the sheet metal.
- ◆ The screw fits in the place of the one you removed earlier.
- ◆ Fix the lock in place by tightening the M3x12 screw.

## STEP 18 PTFE Side Holder parts preparation

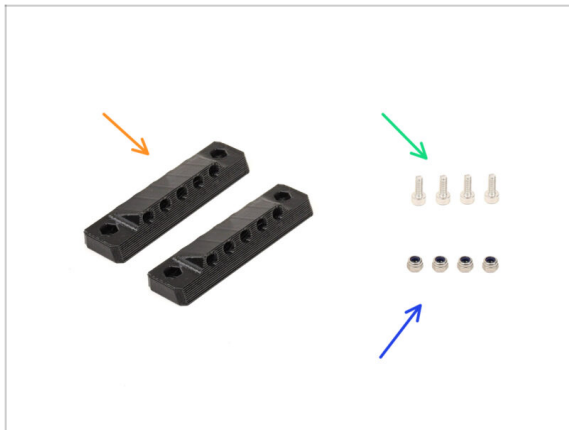

- ◆ **For the following steps, please prepare:**
- ◆ PTFE\_side\_holder (2x)
- ◆ M3x8 screw (4x)
- ◆ M3nN nut (4x)

## STEP 19 PTFE Side Holder Preparation

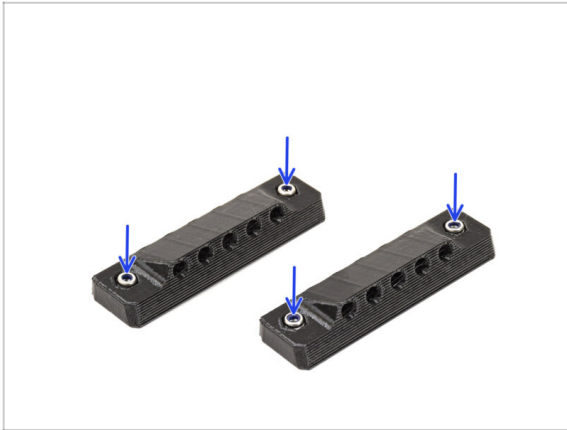

- Insert two **M3nN nuts** into the corresponding openings on both the PTFE side holders.

## STEP 20 PTFE Side Holder Installation 1



- On the left side of the enclosure, remove the marked nylon rivet.
  - From inside the enclosure, push the center pin of the rivet, then pull the entire rivet out from the outside.
- Run two M3x8 screws through the marked openings from the inside of the enclosure to the outside.
- Attach the **PTFE Side Holder** onto the screws.
  - Make sure the **lifted part** of the holder is pointing towards the **front** of the Enclosure!
  - Tighten the screws to fix the holder in place.

## STEP 21 PTFE Side Holder Installation 2

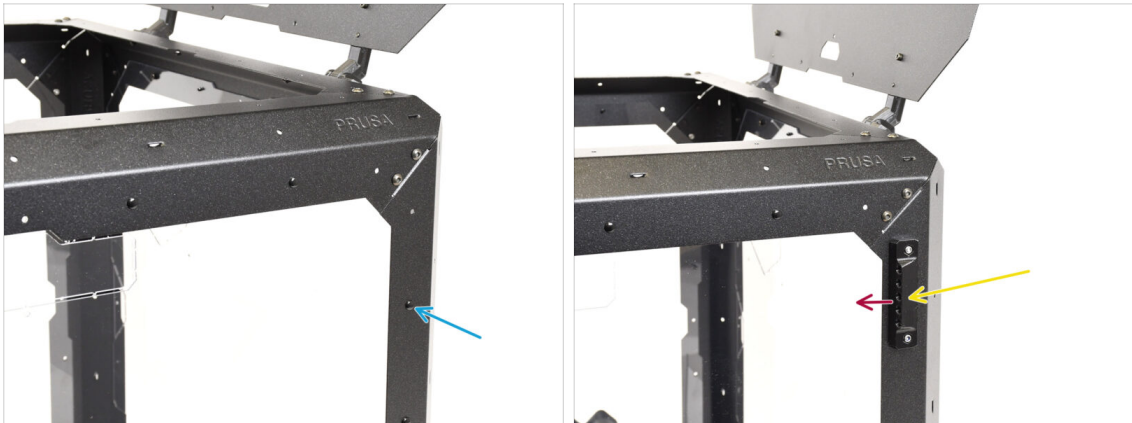

- On the **right** side of the enclosure, remove the marked nylon rivet.
- Using the two **M3x8** screws, fix the other PTFE Side Holder in place.
- Make sure the lifted part of the holder is pointing towards the front of the Enclosure!

## STEP 22 Covers Removal

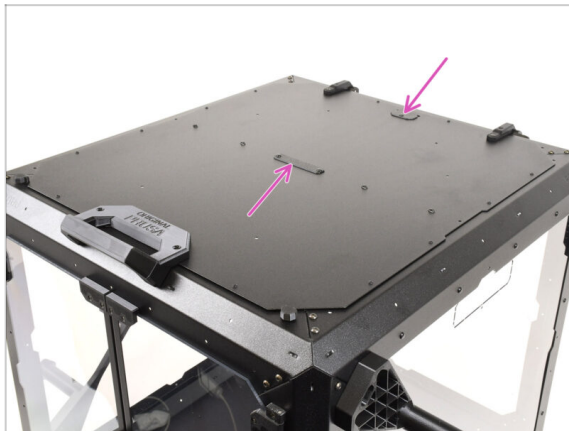

- On top of the Enclosure, remove the marked two covers.
- ① Push the center part of the rivets holding the covers from the bottom, then remove the rivets from the top along with the covers.

## STEP 23 Buffer Mount: parts preparation

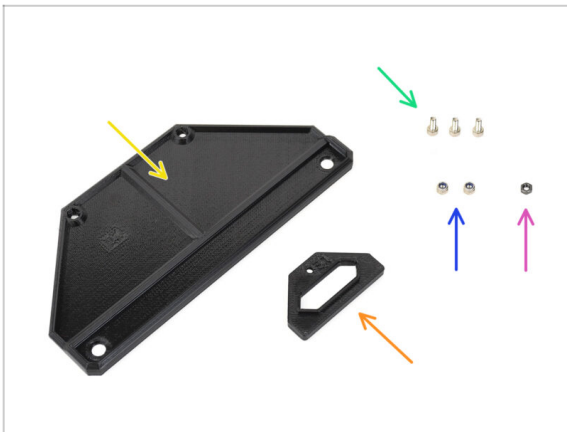

● For the following steps, please prepare:

- Buffer mount (1x)
- M3x6 screw (3x)
- M3nN nut (2x)
- M3n nut black (1x)
- PTFE top passthrough (1x)

## STEP 24 Buffer Mount Installation



- Insert two **M3nN nuts** into the marked openings on the Buffer Mount.
- Place the **Buffer Mount** on top of the enclosure.
- Ensure the part of the mount with the nuts is oriented toward the front of the enclosure.
- Attach the mount to the top lid using two **M3x6 screws** from the bottom.

## STEP 25 PTFE Passthrough Installation



- ◆ Insert the **M3n black nut** into the PTFE passthrough part.
- ◆ Attach the passthrough part onto the back of the top lid.
- ◆ Secure it in place by inserting the **M3x6 screw** from the bottom of the lid and tightening it.

## STEP 26 Buffer Preparation 1



- ◆ Take the Buffer itself.
- ◆ Remove all five cassette cartridges from the buffer.
- ◆ Remove the M3x30 screw holding the Buffer Leg.
- ◆ Remove the Buffer Leg.
- ◆ Reinsert the two M3x30 screws. Tighten them lightly to avoid bending the Buffer.

**STEP 27** Buffer Preparation 2

- ◆ Remove the M3x30 screw holding the printer holder.
- ◆ Remove the countersunk M3x30 screw on the opposite side that secures the printer holder.
- ◆ Remove the printer holder part.

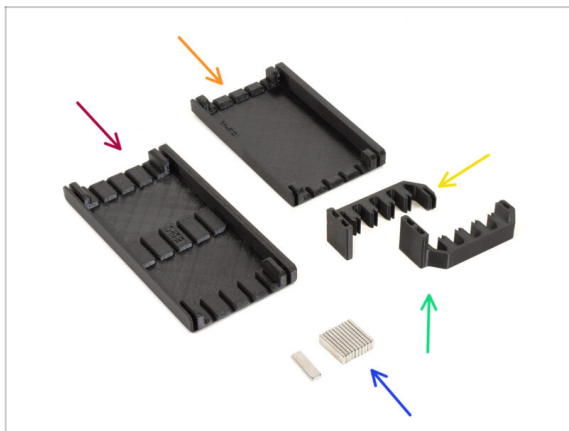
**STEP 28** Enclosure Buffer: parts preparation

◆ **For the following steps, please prepare:**

- ◆ Buffer Side L (1x)
- ◆ Buffer Side R (1x)
- ◆ Buffer Plate Holder L (1x)
- ◆ Buffer Plate Holder R (1x)
- ◆ Magnet 2x6x20 (11x)

⚠ The magnets are strong but brittle. After separating them, keep them a sufficient distance apart to prevent them from shattering.

## STEP 29 Magnets Installation

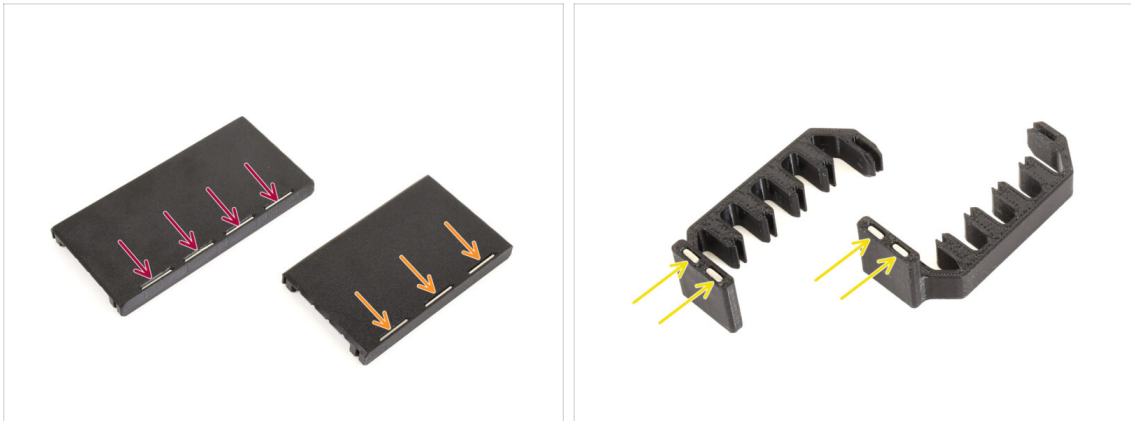

- ◆ Install four magnets into the marked openings on the **Buffer Side L** part.
- ◆ Install three magnets into the marked openings on the **Buffer Side R** part.
- ◆ Install two magnets into the **Plate Holder L**, and the last two magnets into the **Plate Holder R** parts.

## STEP 30 Enclosure Buffer Assembly 1



- ◆ Orient the Buffer as shown in the picture: laying flat with the opening for the cassette segments on the left side.
- ◆ Remove the Plate holder part from the former bottom of the buffer.
  - ⓘ Use needle-nose pliers if the plate holder is difficult to remove.
- ◆ Install the **Buffer Side R** (the part with **three magnets**) onto the Buffer, ensuring the magnets are pointing downwards.
  - ◆ Ensure all the plates are fully engaged into the Side R part.

**STEP 31** Enclosure Buffer Assembly 2

- ◆ Remove the two marked plate holders on the opposite side.
- ◆ Install the **Buffer Side L** part (with four magnets) onto the Buffer.
- ◆ Ensure the magnets are oriented the same way as on the opposite side.

**STEP 32** Enclosure Buffer Assembly 3

- ◆ Remove the two Plate Holders.
- ◆ Install the **Plate Holder L** onto the Buffer, as seen in the picture.
- ◆ Ensure the magnets are oriented to the same side as the other parts.
- ◆ Install the **Plate Holder R** onto the Buffer. Ensure the magnets are oriented to the same side as the other parts.



## STEP 33 Enclosure Buffer Installation

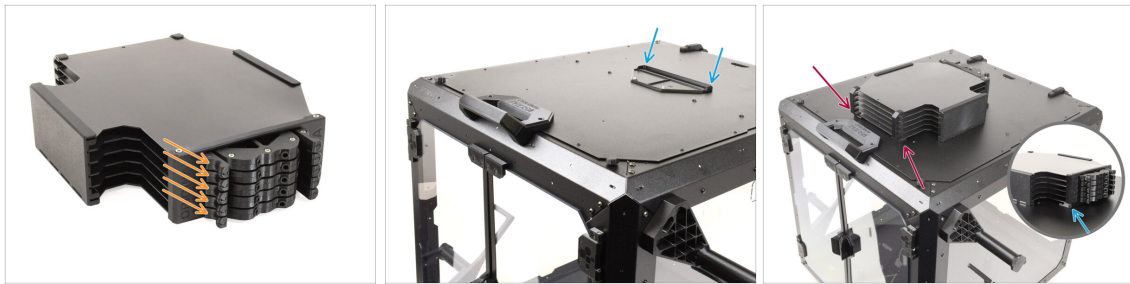

- ◆ Insert all **five cassettes** back into the buffer.
- ◆ Mount the buffer onto the top lid of the enclosure. The part with the cassettes should hook into the plastic part on the top lid.
- ◆ The front part of the buffer should hold securely in place due to the magnets.
- i The enclosure is now ready for the printer installation in the upcoming steps.

## STEP 34 Printer Preparation

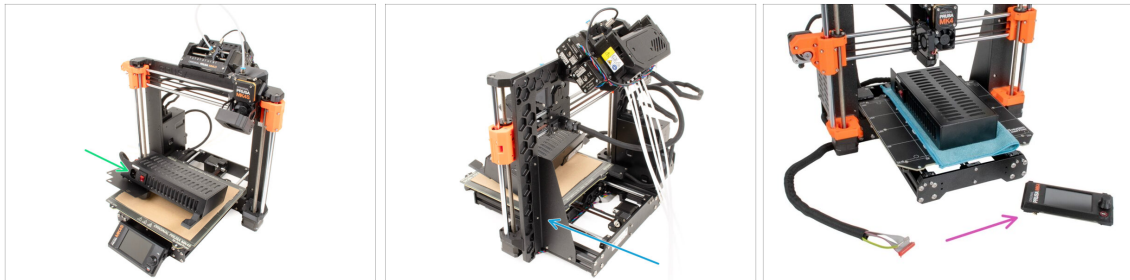

- ◆ Before you place the printer in the enclosure, prepare the printer in this state:
  - ◆ **PSU** is removed from the frame and placed on the protected heatbed
  - ◆ The printer **frame support** is installed on the printer.
  - ◆ If you plan to use the externally mounted **LCD**, you can disconnect and remove it from the printer.

## STEP 35 Printer Installation

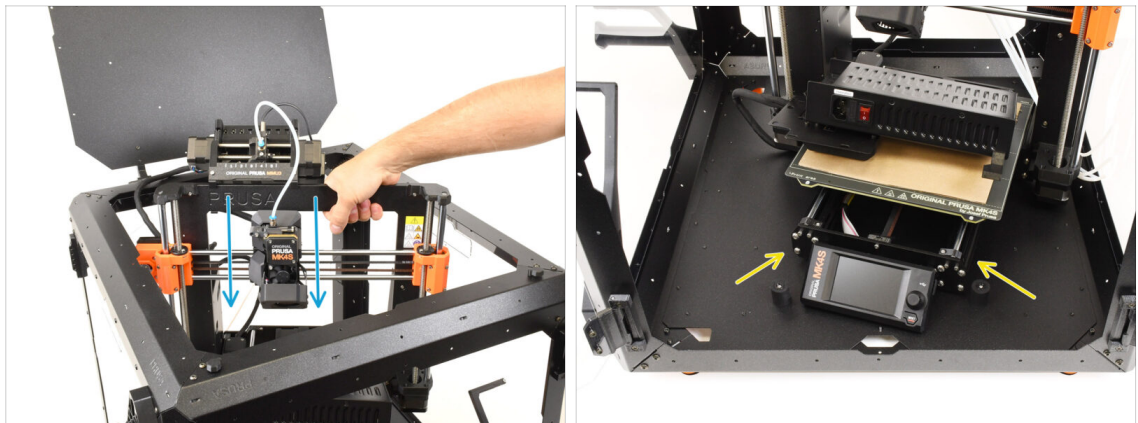

- ◆ Grasp the printer by its frame and carefully insert it into the enclosure at a slight diagonal angle to prevent scratching both the printer and the enclosure.
  - ⚠ **Ensure the printer is not placed on any cables or PTFE tubes!**
- ◆ Place the printer at an angle, as shown in the picture, inside the enclosure, positioning it behind the anti-slip dampers.
- ⓘ This is just a temporary position for the printer. We'll adjust it to the correct position later.

## STEP 36 PSU Installation

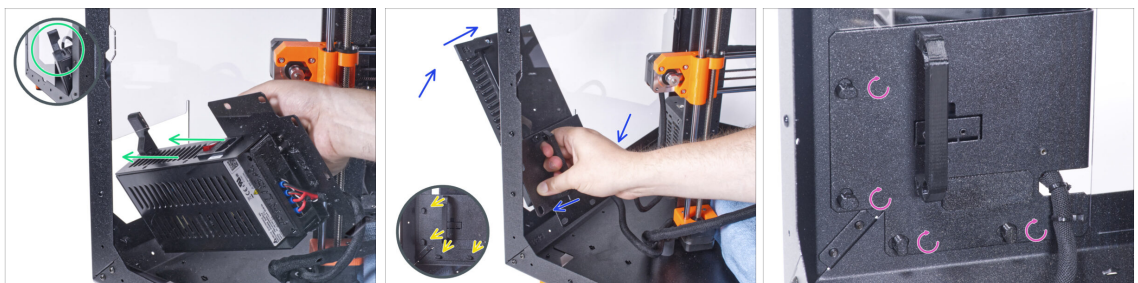

- ◆ From inside the enclosure, grasp the PSU by its handle.
  - 📌 It's more convenient to use your right hand for this task.
- ◆ Insert the PSU through the opening at the bottom of the back panel, starting with the PSU retainer (the part with the magnets).
- ◆ Tilt the PSU towards the back panel, ensuring the PSU remains outside the enclosure while the PSU holder is inside the enclosure.
- ◆ Ensure the PSU holder fits perfectly onto all four PSU locks.
- ◆ Turn all PSU locks 90° to secure the PSU assembly.

## STEP 37 Printer Positioning

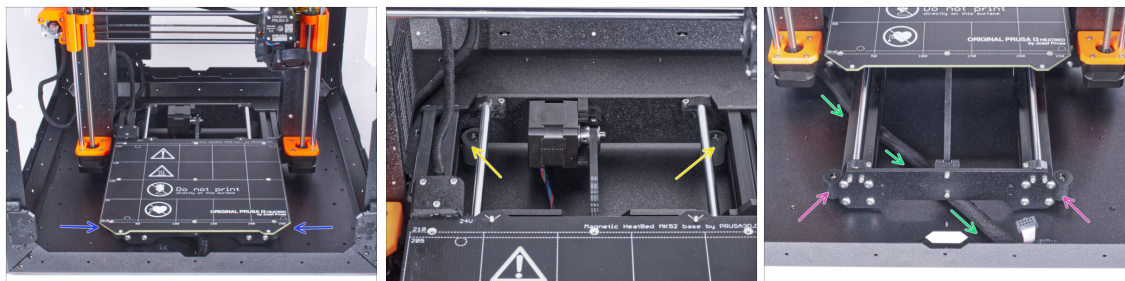

- ◆ Rearrange the printer as shown in the picture. Center it in the enclosure and adjust it to the correct position.
- ◆ Ensure the two rear anti-slip dampers are locked against the rear plate from the inside.
- ◆ The two front anti-slip dampers must be secured against the front plate from the outside.
- ◆ Guide the LCD cable bundle under the printer, from the electronics to the front of the enclosure. Leave the cable loose for now.

## STEP 38 LCD Installation: parts preparation



⚠ If you're using the **externally mounted LCD**, proceed with these steps. If not, skip them.

- ◆ For the following steps, please prepare:
  - ◆ LCD assembly (1x) *compatible with your printer*
  - ◆ M3x8 screw (2x) *you removed earlier*

## STEP 39 LCD Connection

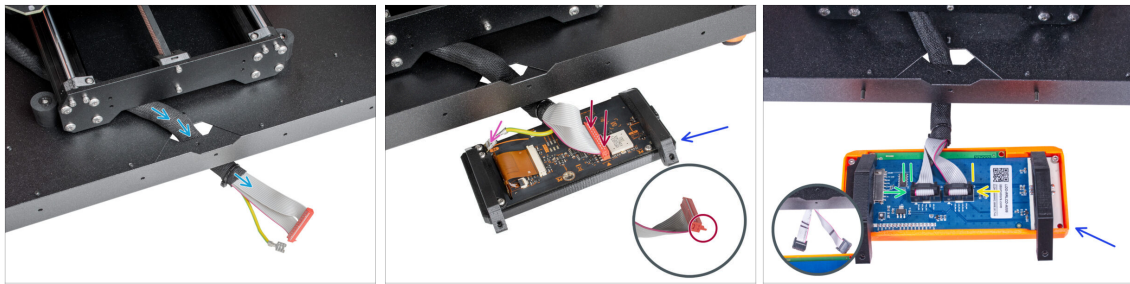

- ◆ Guide the LCD cable bundle through the cutout in the bottom panel.
- ◆ Place the LCD assembly next to the enclosure, ensuring the holders are pointing away from the enclosure, as shown in the picture.
- ◆ **MK4/S:** Connect the xLCD cable to the xLCD board, ensuring the safety latch is properly engaged on the side of the slot marked with the orange triangle on the board.
- ◆ **MK4/S:** Connect the grounding Faston connector onto the xLCD
- ◆ **MK3S+:** Connect the cable marked with two stripes into the left slot (EXP2)
- ◆ **MK3S+:** Connect the cable marked with one stripe into the right slot (EXP1)

## STEP 40 LCD Installation

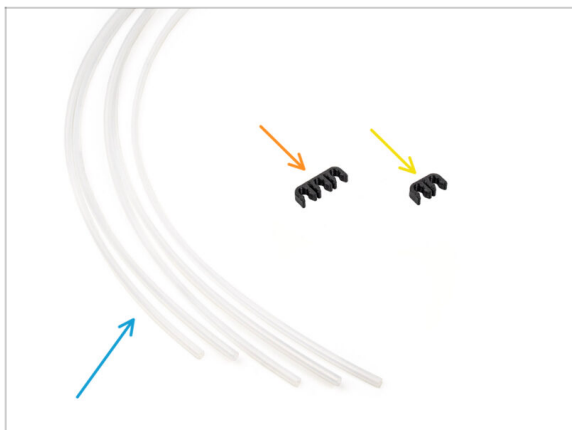

- ◆ Move the LCD assembly towards the enclosure, as seen in the picture.
- ◆ Fix it to the metal profile using two M3x8 screws. Tighten the screws fully.
- ◆ Secure the LCD cable bundle to the bottom of the enclosure. Guide a zip-tie through the perforation and tighten it around the cable bundle.

**STEP 41** PTFE Tubes: part preparation

◆ For the following steps, please prepare:

- ◆ PTFE Tube 4x2.5x1100 (5x)
- ◆ PTFE Clip 3-way (1x)
- ◆ PTFE Clip 2-way (1x)

**STEP 42** PTFE Tube Installation 1

- ◆ Guide the PTFE tubes **from the MMU** unit through the opening at the rear of the top lid of the Enclosure.
- ◆ **Connect the PTFE** tubes to their corresponding numbered cassettes in the Buffer.
- ◆ Insert two 4x2.5x1100 PTFE tubes into cassette positions **4 and 5**.

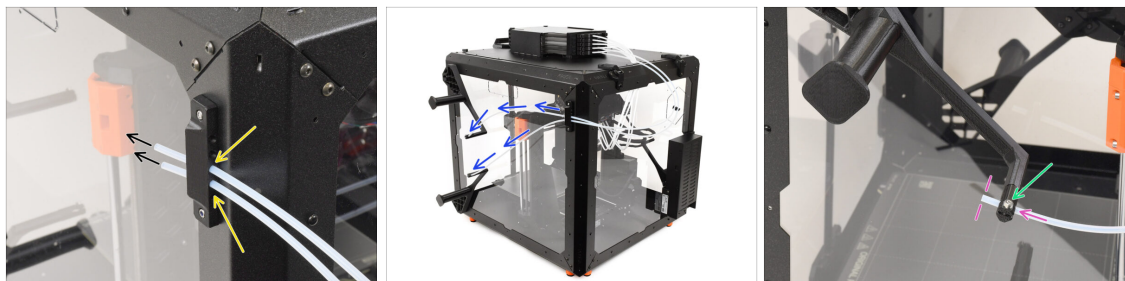
**STEP 43** PTFE Tube Installation 2

- Insert the two PTFE tubes into the **side holder**.
- Guide the PTFE tubes towards the **spool holders** on the right side of the Enclosure (when looking from the front side)
- Push the ends of the PTFE tubes through the cap on each spool holder. The end should be just behind the cap.
- 🔗 The end of the tube should be positioned just behind the cap.
  - If the PTFE tube is difficult to insert, slightly loosen the M3x10 screw.

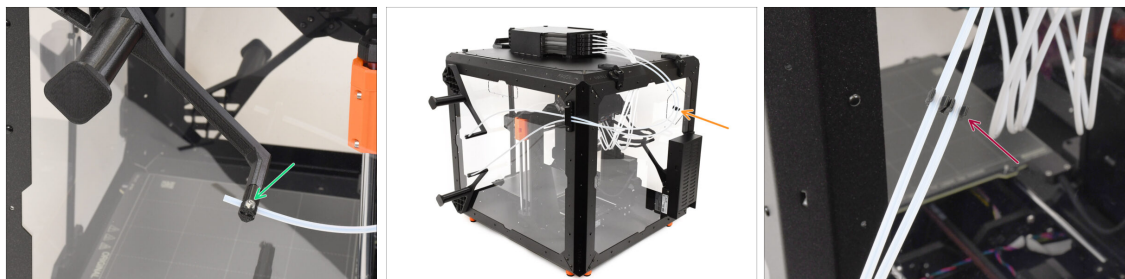
**STEP 44** PTFE Tube Installation 3

- Slightly tighten the **M3x10 screw** on the cap to secure the PTFE tube in place, being careful not to overtighten.
- ⚠️ **Tighten the screw very lightly just so that the PTFE tube holds in place. Do not overtighten, as this could cause filament drag and affect the proper function of the MMU.**
- On the back of the printer, approximately in the middle of the long PTFE tubes...
  - Join the tubes together using the corresponding two-way **clip**.

## STEP 45 PTFE Tube Installation 4

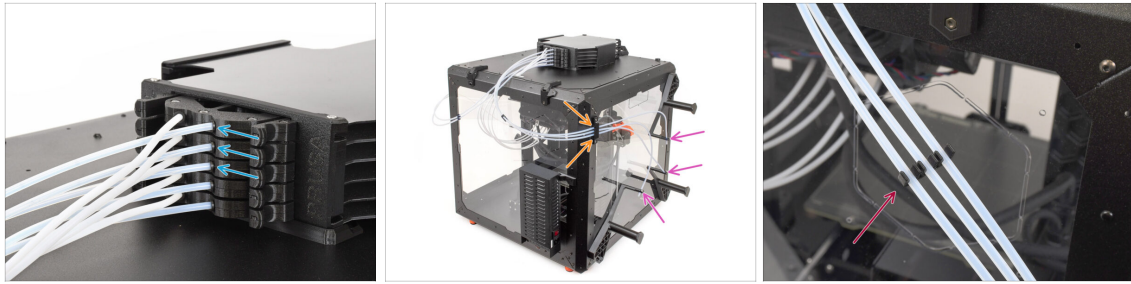

- ◆ Insert three **PTFE tubes** into cassette positions **1, 2, and 3**.
- ◆ Guide the tubes through the **side holder** on the opposite side.
- ◆ Attach the ends of the tubes to the caps on each **spool holder**. Secure them in place by gently tightening the M3x10 screws.
- ◆ Join the tubes together using the corresponding three-way **clip**.

## STEP 46 Loading the Filaments

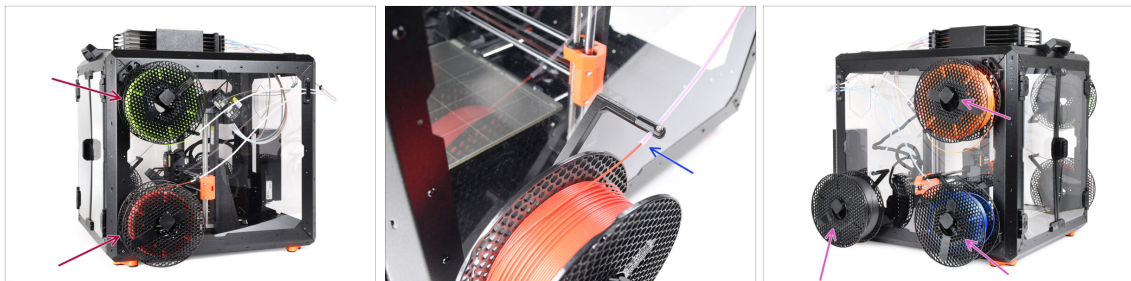

- ◆ To load the filaments, first attach the spools onto the spool holders on the side.
- ◆ Push the filament through the PTFE tube into the buffer, then use the Preload function to load it into the MMU3.
- ◆ Repeat the process to load the remaining filaments.

## STEP 47 Done

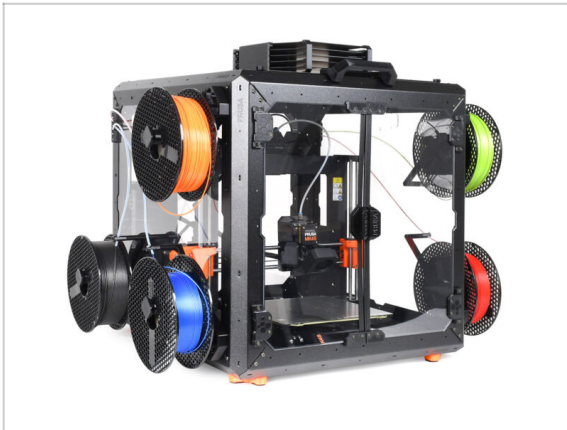

- ◆ Congratulations!
- ◆ You can now start using your MMU3 inside the enclosure.



## 6B. Hinged lid with MMU2S



## STEP 1 Introduction



- ◆ This chapter guides you through the installation of the MMU2S into the Enclosure.
- ◆ The MMU2S can only be installed after the **Hinged Lid** is in place.

## STEP 2 Removing the LCD



- ◆ Carefully cut the zip tie securing the LCD cable bundle.
- ◆ Release two screws mounting the LCD assembly.
- ◆ Disconnect both LCD cables from the LCD.
- ◆ Push the LCD cable bundle through the hole in the bottom panel into the enclosure.

**STEP 3** Removing the filament guide

- ◆ Press down the blue collet on the filament fitting.
- ◆ Pull out the PTFE tube from the fitting.
- ◆ Cut the zip tie securing the PTFE tube on the inner side of the top front profile.
- ◆ Remove the two screws securing the filament guide and take it out of the enclosure.

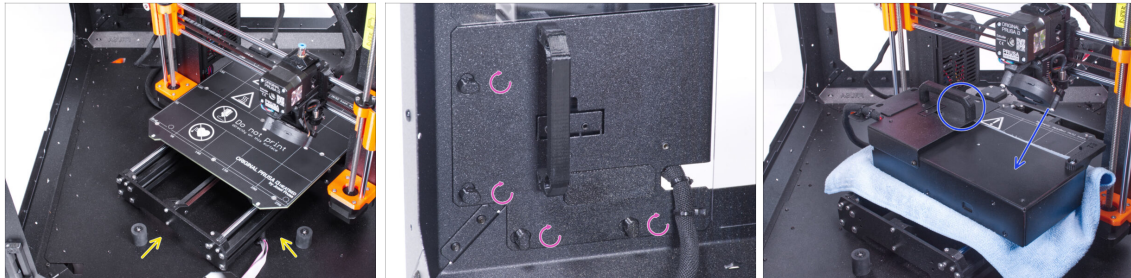
**STEP 4** Removing the printer

- ⓘ The following instructions show the MK3S+ with a black PSU, but the procedure is identical for the silver PSU.
- ◆ Place the printer at an angle (as shown) inside the enclosure, positioning it behind the anti-slip dampers.
- ◆ Unlock all PSU locks, then grasp the handle and remove the PSU assembly from the back panel.
- ◆ Place the PSU on the heatbed, protected by a cloth, with the PSU handle facing upwards.

## STEP 5 Removing the printer

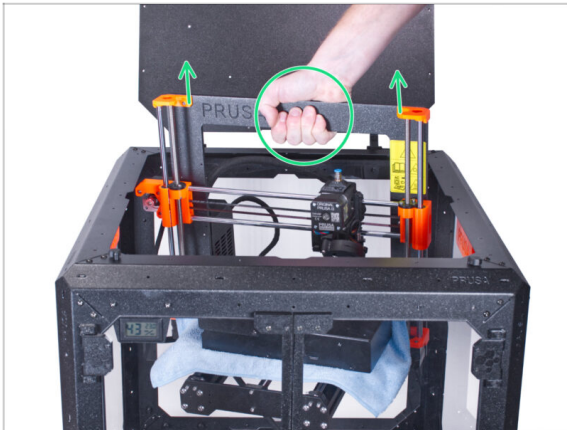

- ◆ Open the lid.
- ◆ Grasp the printer by its frame and carefully lift it out of the enclosure.
- ⚠ **Avoid scratching the printer and enclosure.**

## STEP 6 Installing the MMU2S



- ◆ Now, proceed to the instructions for installing the MMU2S unit on the printer.
- ◆ The procedure will vary slightly depending on whether the MMU2S unit was only temporarily removed from the printer during the enclosure assembly, or whether it was never installed on the printer at all. **Choose your option:**
  - ◆ **Brand new installation of the MMU2S unit on the printer:** go to [Original Prusa i3 to MMU2S upgrade manual](#).
  - ◆ **Re-mounting the MMU2S unit to the printer:** go to [Assembling the MMU2S unit](#).
- ⓘ After you have finished installing the MMU2S unit on the printer, return to this guide and continue with the next step.

## STEP 7 Preparing the printer (MK3S+ with MMU2S)



- Before you place the printer in the enclosure, prepare the printer in this state:
  - LCD is disconnected and removed from the printer
  - PSU (both black and silver version) is removed from the frame and placed on the protected heatbed
  - The printer frame support is installed on the printer

## STEP 8 Installing the printer

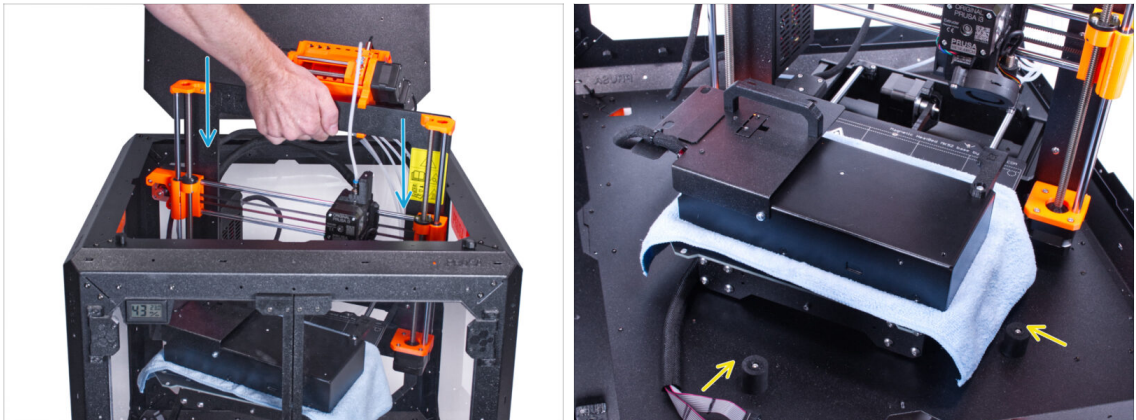

- Grasp the printer by its frame and carefully insert it into the enclosure at a slight diagonal angle to **avoid scratching the printer and enclosure**.
- ⚠ **Avoid placing the printer on cables and PTFE tubes!**
- Place the printer at an angle (as shown in the picture) in the enclosure behind the anti-slip dampers.
- ⓘ It's just a temporary position for the printer. We will adjust the correct position later.

## STEP 9 Installing the PSU

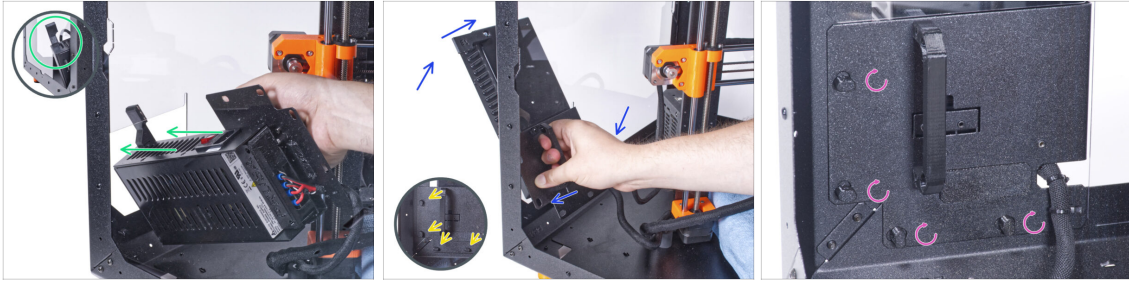

- ◆ From inside the enclosure, grasp the PSU by its handle in your hand.
  - ⓘ It is more convenient to use the right hand.
- ◆ Insert the PSU through the hole at the bottom of the back panel. Start by pushing through the part with the PSU-retainer (the part with the magnets).
- ◆ Tilt the PSU towards the back panel, ensuring the PSU remains outside the enclosure while the PSU holder is inside the enclosure.
- ◆ Ensure the PSU holder fits perfectly onto all four PSU locks.
- ◆ Turn all PSU locks 90° to secure the PSU assembly.

## STEP 10 Adjusting the printer

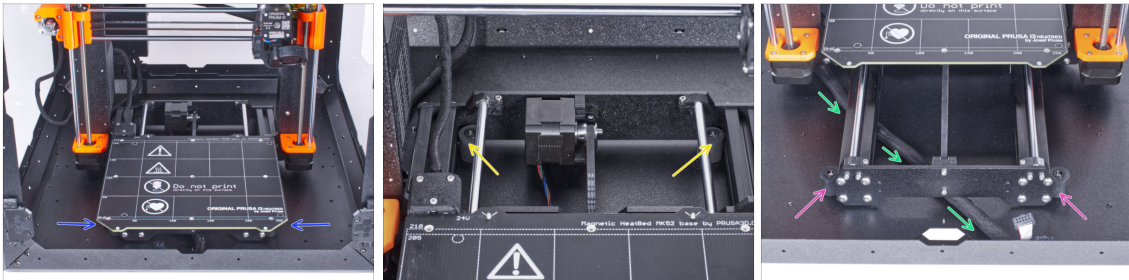

- ◆ Rearrange position of the printer like in the picture. Place it in the center of the enclosure and adjust the correct position:
  - ◆ Ensure the two rear anti-slip dampers are locked against the rear plate from the inside.
  - ◆ The two front anti-slip dampers must be secured against the front plate from the outside.
- ◆ Guide the LCD cable bundle under the printer, from the electronics to the front of the enclosure. Leave the cable loose for now.

## STEP 11 Mounting the LCD: parts preparation

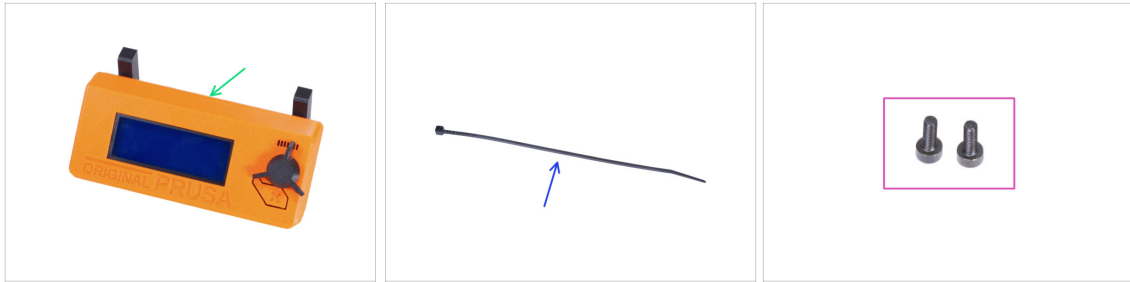

◆ For the following steps, please prepare:

- ◆ LCD assembly (1x)
- ◆ Zip tie (1x)
- ◆ M3x8 screw (2x) *you removed earlier*

## STEP 12 Mounting the LCD

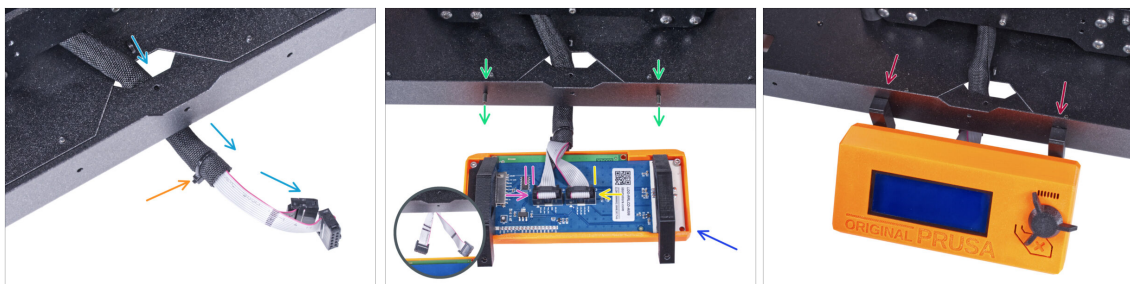

- ◆ Guide the LCD cable through the cutout in the bottom panel.
  - ◆ Secure the textile sleeve on the cable bundle with the zip tie. **Do not over tighten the zip tie**, it may cut the cables!
  - ◆ From the inside, push two M3x8 screws through the bottom profile.
  - ◆ Place the LCD assembly close to the LCD cables, like in the picture. Mind the same orientation of the LCD as in the picture. See the LCD-supports for better understanding.
- ⚠ **Note that both cables are marked with stripes on one side. Correct connection order is important!**
- ◆ Connect the LCD cable marked with **TWO STRIPES** to the **left slot** (called EXP2) on the LCD controller.
  - ◆ Connect the LCD cable marked with **ONE STRIPE** to the **right slot** (called EXP1) on the LCD controller.
  - ◆ Slide the LCD assembly onto the two M3x8 screws in the frame and tighten them.

**STEP 13** Assembling the grommets: parts preparation

◆ For the following steps, please prepare:

- ◆ MMU-grommet (2x)
- ◆ M3x8 screw (2x)
- ◆ M3n nut (2x)

**STEP 14** Assembling the MMU-grommets

ⓘ There are two symmetrical grommets for both edges of the enclosure's rearside. In case you intend to place all spools only on one side outside the enclosure, you can use just one grommet.

- ◆ Using the Allen key, remove the print support from both MMU-grommets.
- ◆ Insert the M3n nut into each MMU-grommet.



## STEP 15 Mounting the MMU-grommets



- ① Depending on where you will place your spools, cut out the left, right, or both sides.
- ◆ From inside of the enclosure, use the knife and **CAREFULLY** cut off all supports of the left grommet cutout on the back panel and remove it.
- ◆ From inside of the enclosure, use the knife and **CAREFULLY** cut off all supports of the right grommet cutout on the back panel and remove it.

## STEP 16 Mounting the MMU-grommets



- ◆ From inside, push the M3x8 screw through the hole next to the left grommet cutout.
- ◆ From the outside, attach the MMU-grommet in the same orientation to the cutout and the screw. Tighten the screw.

## STEP 17 Mounting the MMU-grommets (optional)



- From inside, push the M3x8 screw through the hole next to the right grommet cutout.
- From the outside, attach the MMU-grommet in the same orientation to the cutout and the screw. Tighten the screw.

## STEP 18 Guiding the PTFE tubes

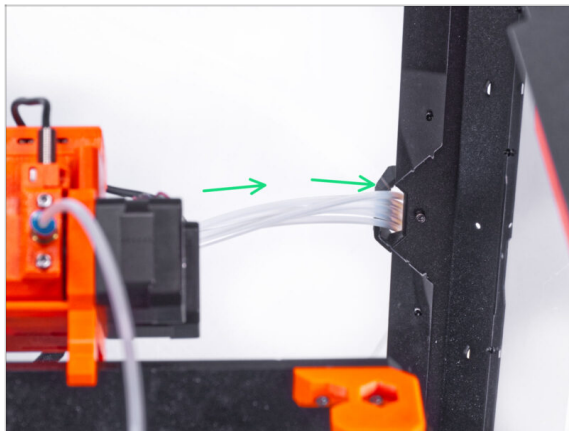

- Merge all PTFE from the MMU2S and push them through the right MMU-grommet out of the enclosure.
- ⓘ You can use the left MMU-grommet as well. The procedure is the same.

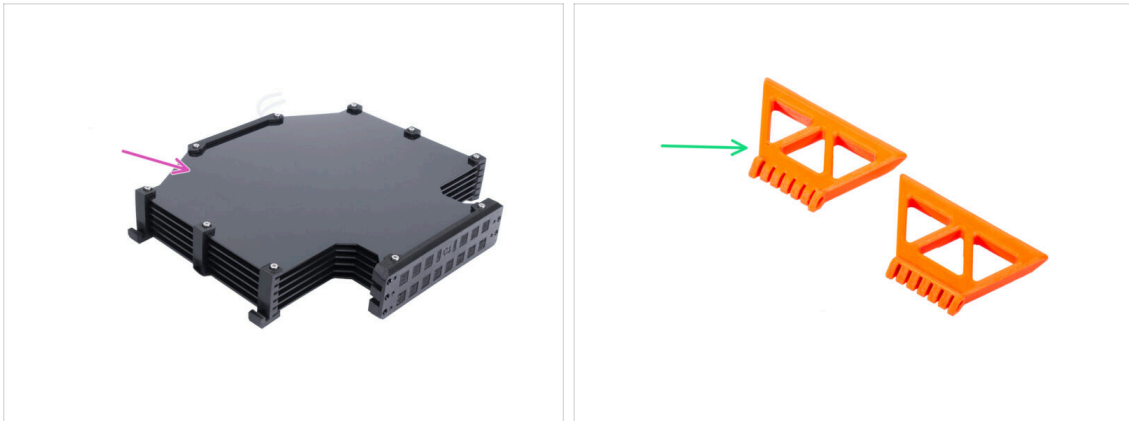
**STEP 19** Assembling the buffer feet: parts preparation

● For the following steps, please prepare:

- Buffer assembly (1x)
- MMU-buffer-foot (2x)

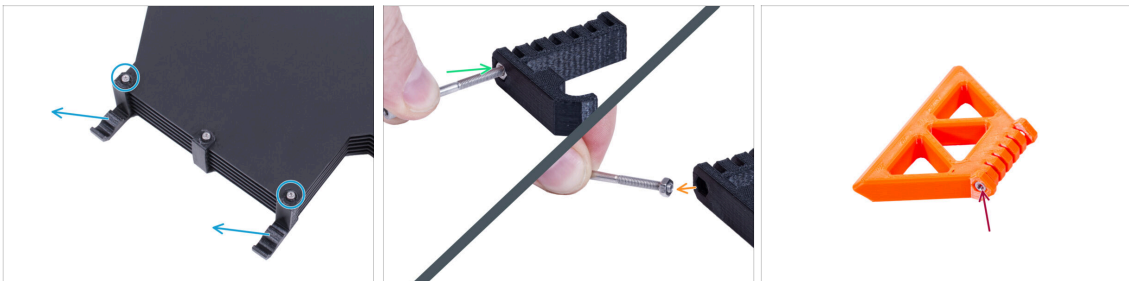
**STEP 20** Assembling the buffer feet

- Release two screws securing the s-buffer-hook-uni and remove the printed part from the buffer.
  - Insert the screw into the nut in the s-buffer-hook-uni. Do not screw it completely, a few turns are enough.
  - Pull the screw and the nut out of the printed part. Take off the nut from the screw.
    - ⓘ If it is difficult to pull the nut this way, take the spare M3n nut from the Enclosure kit package.
  - Do the same to extract the nut from the second s-buffer-hook-uni.
  - Insert the M3n nut into each MMU-buffer-foot.
- ⚠ **Do not discard the screws, you will need them later again!**

**STEP 21** Mounting the buffer feet

- Place and orient the buffer assembly as in the picture. Use the PTFE tubes as a guide.
- Mount the MMU-buffer-foot on the right bottom edge of the buffer assembly.
- Secure the MMU-buffer-foot with the M3x40 screw.

**STEP 22** Mounting the buffer feet

- Turn the buffer so that the mounted MMU-buffer-foot is on the left side.
- Attach the second MMU-buffer-foot on the second bottom corner of the buffer assembly.
- Secure the MMU-buffer-foot with the M3x40 screw.

## STEP 23 Joining the buffer

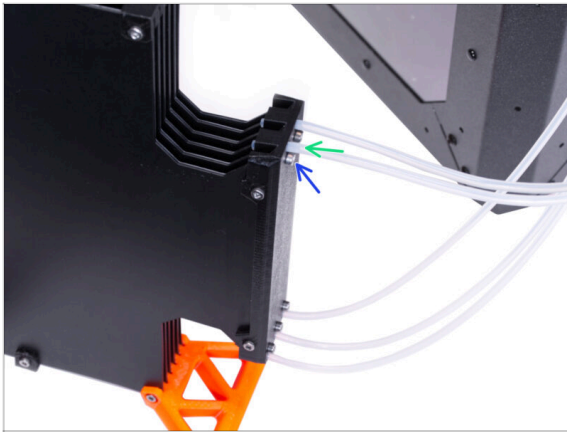

- ◆ Insert the PTFE from MMU2S unit to the buffer.
- ◆ Secure the PTFE tube by tightening the M3x12 screws. Don't over-tighten the screw. Excessive friction in the PTFE might cause issues during the printing later.
- ◆ Repeat the same for all the other PTFE tubes. You can organize the filament positions according to your preference.

## STEP 24 That's it!

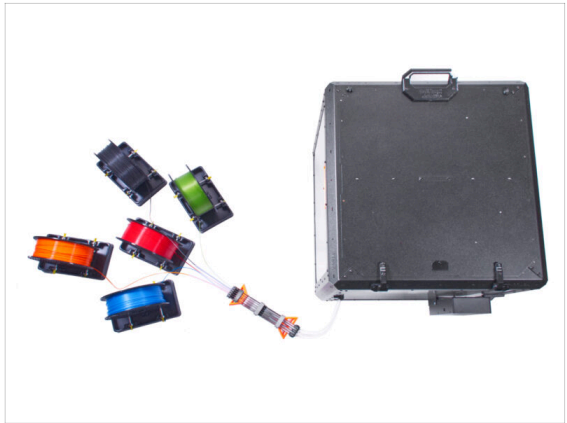
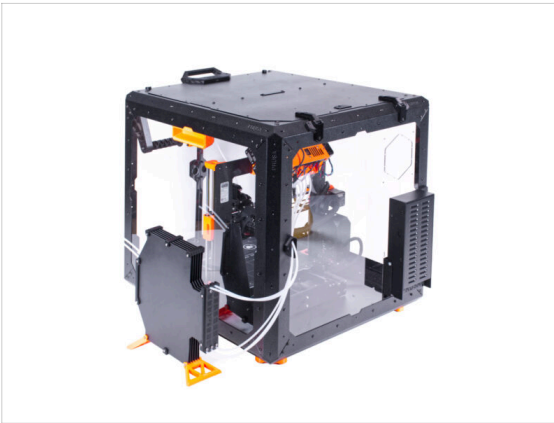

- ◆ Arrange the buffer and filaments.
  - ⓘ As an example, you can use the arrangement tested by us, which you can see in the picture.

## 7. Advanced filtration system (add-on)



## STEP 1 Introduction

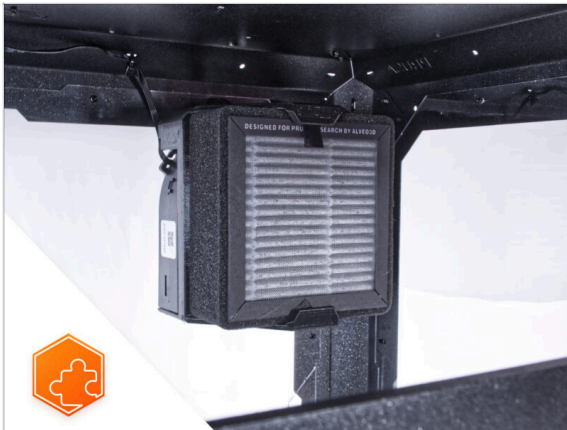

- ◆ This guide will take you through the installation of the **Advanced filtration system** on the **Original Prusa Enclosure**.
- ⓘ The supplied fasteners include extra spare parts.
- ⓘ Please note, that the filtration utilizes internal air circulation. There is no need to punch/drill any holes in the enclosure.

## STEP 2 Different external PSU

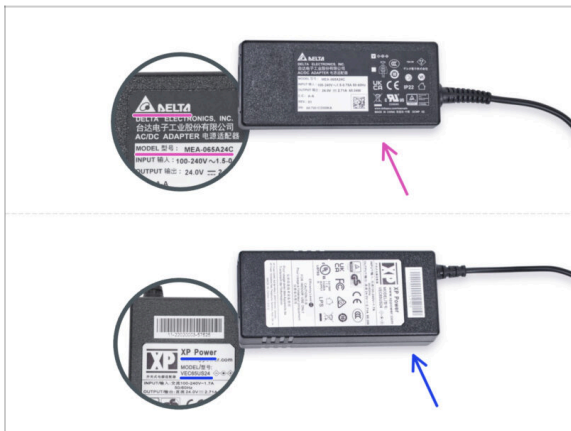

- ⓘ The Advanced filtration system add-on has been shipped with two types of the external PSU, each from a different manufacturer. The functionality of both versions is the same, but the installation procedure is slightly different.
- ◆ On the label of the external PSU, check what model do you have and follow the appropriate instructions:
  - ◆ **External PSU Delta model MEA-065A24C:** go to [Introduction - External PSU Delta](#)
  - ◆ **External PSU XP Power model VEC65US24:** go to [Introduction - External PSU XP Power](#)

### STEP 3 Introduction - External PSU Delta



- ◆ The following instructions are intended for installing the **Advanced filtration system** with the **External PSU Delta model MEA-065A24C** on the **Original Prusa Enclosure**.
- ◆ **Before you start installing the add-on, PRINT OUT ALL NECESSARY PLASTIC PARTS!** The External-PSU-bracket-DELTA and the Basic-board-cover are available for download at [Printables.com](https://Printables.com)
- ⓘ Note: the External-PSU-bracket-DELTA is intended for mounting the external PSU to the enclosure. However, it is not necessarily required.

### STEP 4 Tools necessary for this chapter



- ⓘ Tools are not included in the add-on package.
- ◆ **For this chapter, please prepare:**
- ◆ 2.5mm Allen key
- ◆ Needle-nose pliers (*to trim the zip ties*)
- ◆ Piece of cloth or fabric at least 15 x 15 cm



## STEP 5 Mounting the external PSU (optional): parts preparation



**i** Note: the External-PSU-bracket-DELTA is intended for mounting the external PSU to the enclosure. However, it is not necessarily required. If you do not want to install the External PSU bracket, go to [Preparing the printer](#).

**■** For the following steps, please prepare:

- External PSU (1x)
- M3x8 screw (1x)
- M3nS nut (1x)
- External-PSU-bracket-DELTA (1x)

## STEP 6 Mounting the external PSU (optional)



- Insert the M3nS nut into the External-PSU-bracket-DELTA. Using the Allen key, push the nut all the way into the printed part and align the nut with the hole in the part.

## STEP 7 Assembling the external PSU bracket (optional)



- ✦ Insert the external PSU into the External-PSU-bracket-DELTA and push it all the way in. Mind the correct orientation of the PSU.
- ✦ Guide the external PSU cable like in the picture and attach the cable ferrite into the clip on the printed part.

## STEP 8 Preparing the printer

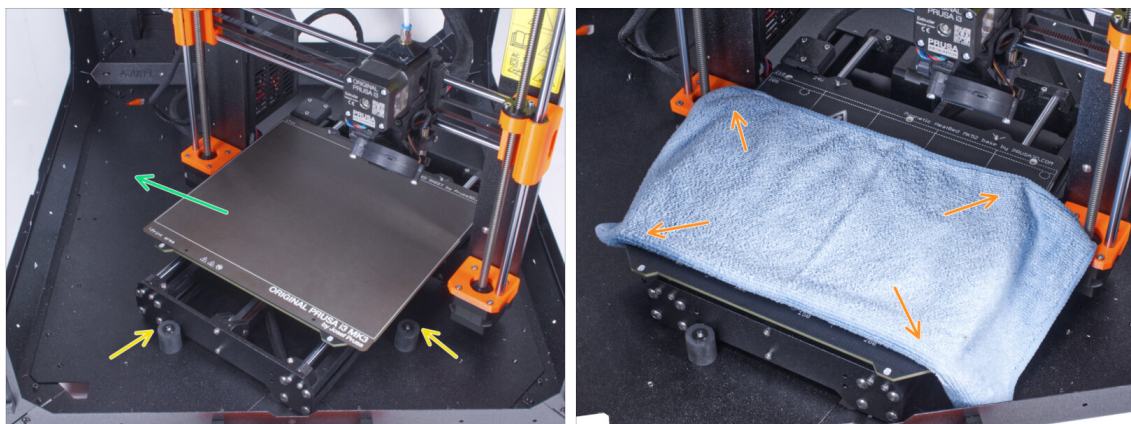

- ⬛ Open the door of the enclosure.
- ✦ Place the printer at an angle (as shown in the picture) in the enclosure behind the anti-slip dampers.
  - ⓘ It's just a temporary position for the printer. We will adjust the correct position later.
- ✦ Take off the steel sheet from the heatbed.
- ✦ Spread a piece of cloth on the heatbed.

## STEP 9 Removing the PSU

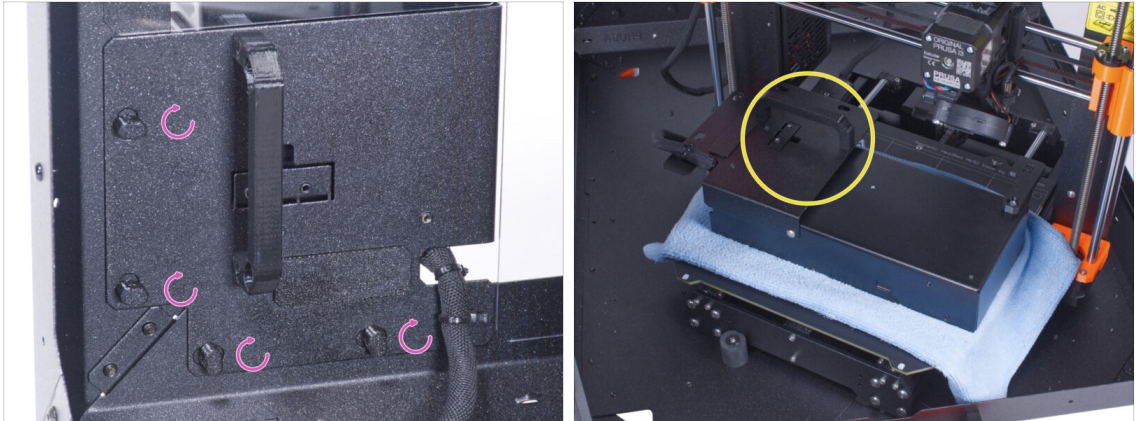

- ◆ "Unlock" all PSU-locks. Grasp the PSU assembly by its handle and remove it from the back panel.
- ◆ Place the PSU on the heatbed protected with the cloth. Turn it with the PSU-handle facing upwards.

## STEP 10 Guiding the external PSU cable

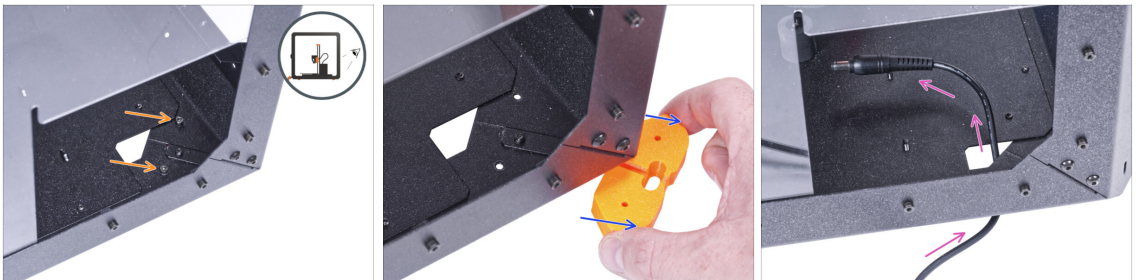

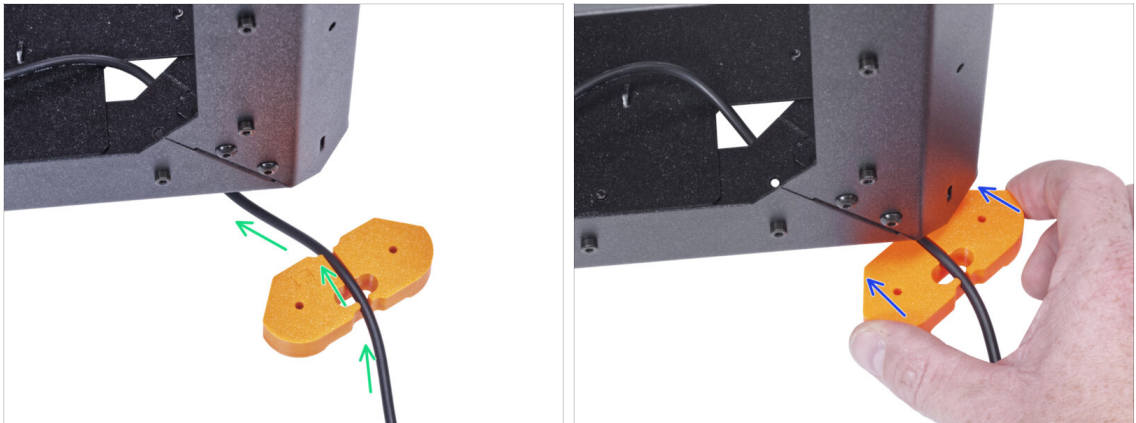

- ⚠ **Be careful not to pinch your fingers when handling under the enclosure.**
- ⓘ If handling the enclosure is difficult due to its weight, you can remove the printer out.
- ◆ Turn the enclosure with the rear side facing you.
- ◆ Through the rectangular hole in the back panel, release two screws mounting the foot to the bottom panel.
- ◆ Remove the foot from the bottom of the enclosure. **Do not discard the part**, you will need it again in a while.
- ◆ Guide the PSU cable through the hole in the bottom panel into the enclosure.

## STEP 11 Guiding the external PSU cable





 **Be careful not to pinch your fingers when handling under the enclosure.**

-  Guide the external PSU cable through the channel in the feet bracket. **See the orientation of the feet bracket.**
-  Slide the feet bracket with the cable under the corner of the enclosure.

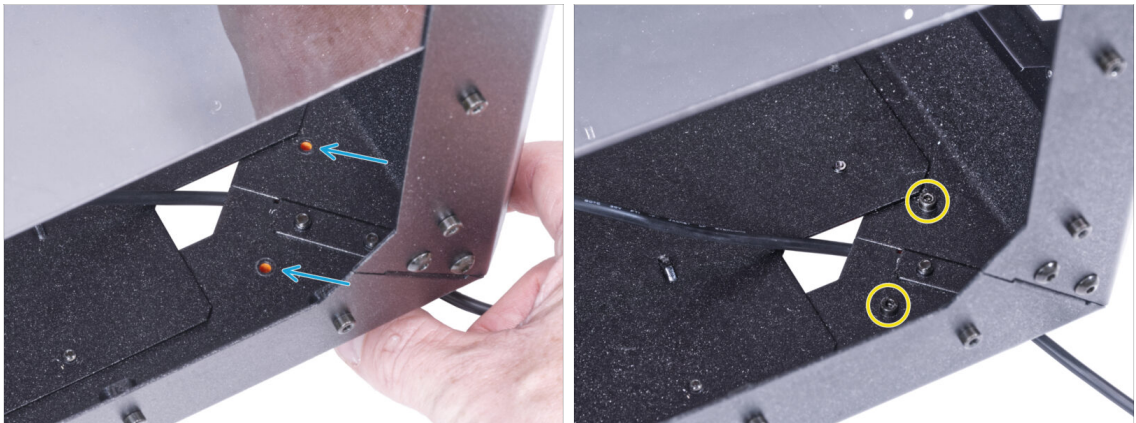
## STEP 12 Guiding the external PSU cable (optional)



 **Be careful not to pinch your fingers when handling under the enclosure.**

-  The following instructions are for mounting the external PSU to the enclosure. If you do not want to mount the external PSU to the enclosure, go to [Installing the PSU](#).
-  Align the holes in the feet bracket with the holes in the bottom profiles.
-  Secure the feet bracket with two M3x12 screws.

## STEP 13 Mounting the external PSU (optional)



- The following instructions are for mounting the external PSU to the enclosure, which is optional. If you do not want to mount the external PSU to the enclosure, go to [Installing the PSU](#).
- From the inside, push the M3x8 screw through the hole in the bottom profile next to the PRUSA logo.
- Attach the external PSU assembly on profile. And align it against the screw.
- Tighten the M3x8 screw from inside to mount the external PSU.

## STEP 14 Installing the PSU



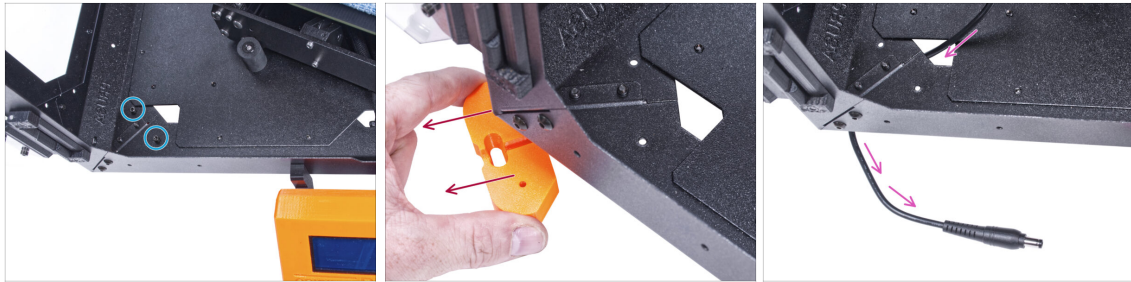

- Ensure the PSU-locks are still turned at the same position:
  - **On the bottom frame**, turn the PSU-locks to the horizontal position.
  - **On the support**, turn the PSU-lock to the vertical position.
- Push the PSU through the opening in the back panel.
- Attach the PSU-holder on the all PSU-locks.
- Turn all PSU-lock 90° to lock the PSU assembly.

## STEP 15 Guiding the external PSU cable





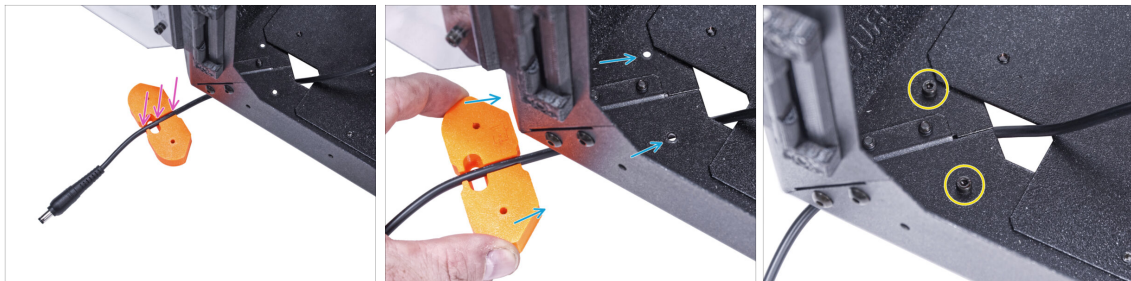

 **Be careful not to pinch your fingers when handling under the enclosure.**

-  Release two screws mounting the front left foot.
-  Remove the foot from the enclosure. **Do not discard the part**, you will need it again in a while.
-  Guide the external PSU cable through the hole in the bottom panel out of the enclosure.

## STEP 16 Guiding the external PSU cable



 **Be careful not to pinch your fingers when handling under the enclosure.**

-  Guide the external PSU cable through the channel in the feet bracket.
-  Slide the feet bracket with the cable under the corner of the enclosure and align the holes in the part with the holes in the bottom profile.
-  Secure the feet bracket with two M3x12 screws.
-  Leave the external PSU cable free for now. We will connect it later on.

## STEP 17 Assembling the filtration: parts preparation

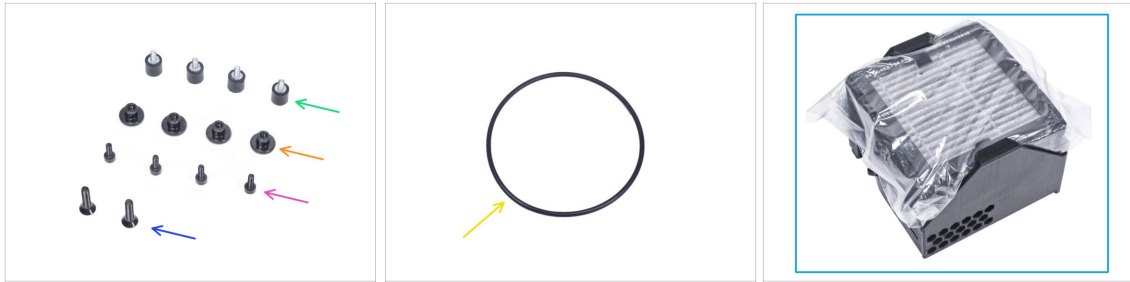

◆ For the following steps, please prepare:

- ◆ Damper (4x)
- ◆ Thumb nut M3 (4x)
- ◆ M3x8 screw (4x)
- ◆ M4x16b countersunk screw (2x)
- ◆ Blower o-ring (1x)
- ◆ Filtration pack (1x)

## STEP 18 Assembling the filtration: parts preparation



◆ Push out the filter from the filtration pack and **divide the pack into these individual parts:**

- ◆ High Pressure Blower (1x)
- ◆ HEPA filter (1x)
- ◆ Filter-Bracket (1x)

## STEP 19 Assembling the filtration

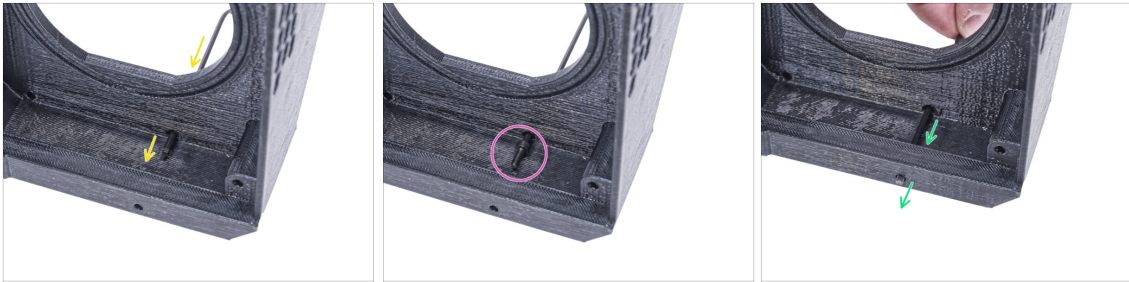

- Place the Filter-Bracket like in the picture and push the Allen key through the hole as you can see.
- Attach the M3x8 screw on the tip of the Allen key.
- Using the Allen key, push the screw all the way through the front hole of the bracket. The screw must protrude partially.

## STEP 20 Assembling the filtration



- Tighten the damper on the screw.
- Repeat the same procedure to install the second damper.



## STEP 21 Assembling the filtration

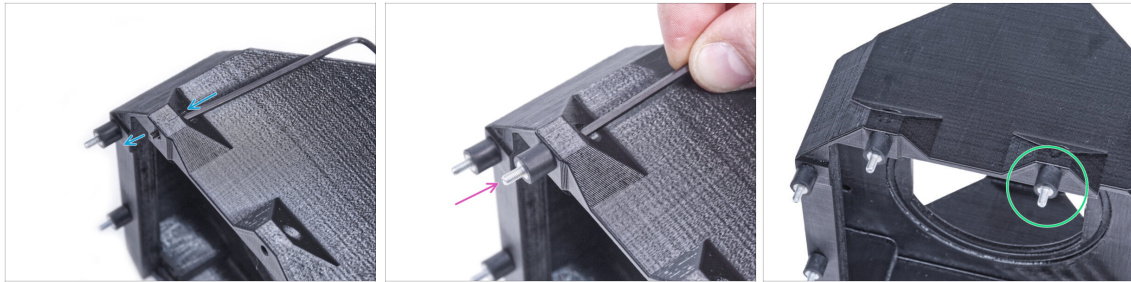

- Using the Allen key push the M3x8 screw through the protrusion on the other side of the Filter-Bracket.
- Tighten the damper on the screw.
- Repeat the same procedure to install the second damper.

## STEP 22 Installing the blower



- Place the Blower o-ring into the Filter-Bracket.
- Insert the High Pressure Blower into the Filter-Bracket so that the blower of the fan faces the hexagonal holes in the printed part.
- Join both parts together with two M4x16b countersunk screws.

### STEP 23 Inserting the HEPA filter



◆ Tear open the filter bag and remove the HEPA filter.

⚠ **Handle the filter with caution.** If the HEPA surface (the white pleated surface) is damaged, the filter will lose its efficiency. Protect your hands when you take off the used filter and put it in a plastic bag. A saturated filter is not recyclable.

### STEP 24 Inserting the HEPA filter



◆ Orient the filtration assembly according to the picture. Make sure that two brackets are facing you and the cable is pointing to the left.

⚠ **Make sure that the HEPA filter is already removed from the bag.**

◆ From the left, push the HEPA filter all the way into the Filter-Bracket. Mind the orientation of the filter.

## STEP 25 Installing the filtration

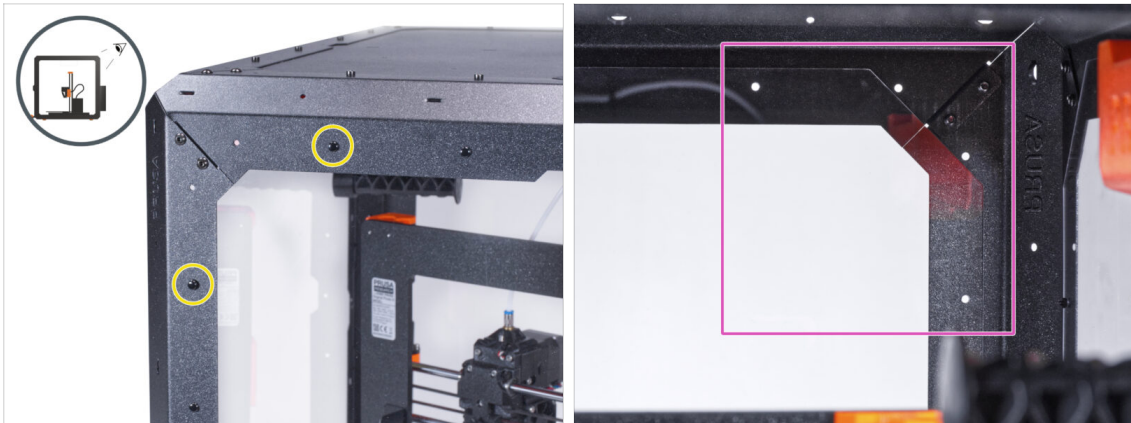

- On the rear side of the enclosure, pull out two nylon rivets on the top left corner.
  - ⓘ From the inside, push on the nylon rivets using your thumb or the tip of the needle-nose pliers. **When using the pliers, be careful not to damage the back panel and sheet metal profile.**
- From the inside, focus on the rear top right corner. The area we will attach the filtration.

## STEP 26 Installing the filtration



- From inside, attach the filtration in the top right corner area so that the dampers are protruding through the holes in the rear profiles.
- Secure the right and lower damper screws by tightening two thumb nuts.

## STEP 27 Installing the filtration



- Secure the remaining two damper screws on the filtration assembly with two thumb nuts.
- To make sure, firmly tighten all thumb nuts with your hand.

## STEP 28 Guiding the filtration cable: parts preparation

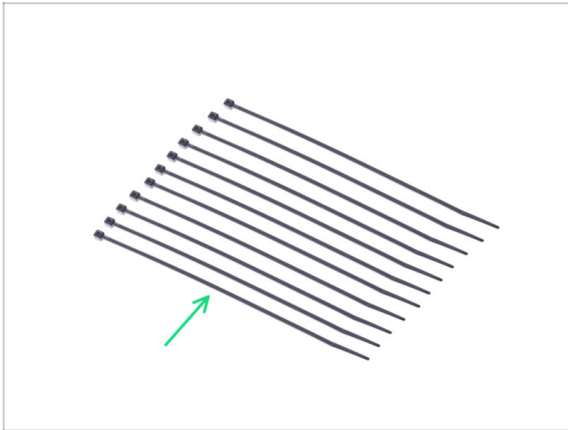

- For the following steps, please prepare:
- Zip tie (11x)

## STEP 29 Guiding the filtration cable



- ◆ Untie the filtration cable and leave it free.
- ◆ Push the zip tie through all three perforations on the top rear profile. Mind the orientation of the zip ties.
- ◆ Guide the filtration cable over the zip ties along the top profile.
- ◆ Secure the cable by tightening each zip tie.

⚠ **Do not overtighten the zip ties, you can damage the cable.**

## STEP 30 Guiding the filtration cable



- ◆ Push four zip ties through the perforations on the left rear support profile.
- ◆ Guide the filtration cable over the zip ties.
- ◆ Tighten all the zip ties to secure the cable position.

⚠ **Do not overtighten the zip ties, you can damage the cable.**

### STEP 31 Guiding the filtration cable

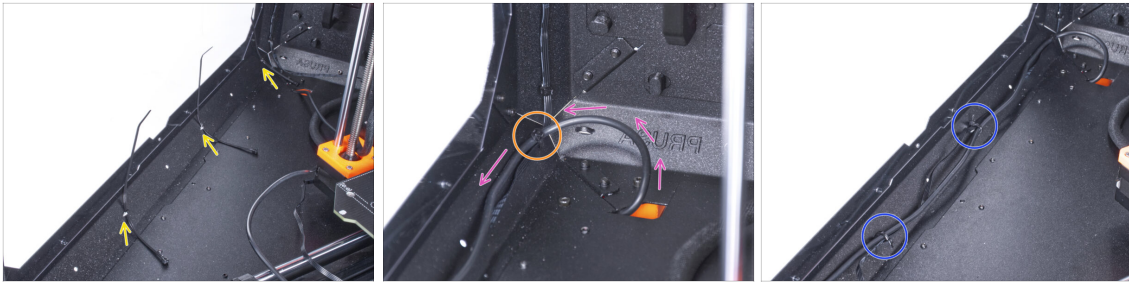

- Push three zip ties through the perforation in the bottom left profile.
- Make a loop with the PSU cable according to the picture.
- Merge the filtration cable and the PSU cable and guide them together. Secure both cables with the first zip tie on the bottom profile.
- Guide the cable along the bottom profile over the zip ties and tighten two remaining zip ties.

### STEP 32 Guiding the filtration cable



- Guide the filtration cable through the hole in the bottom panel out of the enclosure.
- Make a small loop with the external PSU cable.
- Secure the PSU cable with the zip tie to the perforation on the bottom profile.
- Rearrange position of the printer like in the picture. Place it in the center of the enclosure and adjust the correct position

## STEP 33 Installing the basic board: parts preparation



● For the following steps, please prepare:

- Basic-Board-Cover (1x)
- Basic board (1x)
- M3x12 screw (2x)
- M3w serrated lock washer (2x)
- M3nS nut (2x)

## STEP 34 Installing the basic board



- Mount the M3nS nut on the M3x12 screw. Attach it in a few threads on the tip of the screw.
- Push the screw with the nut all the way into the same shape hole inside the Basic-Board-Cover.
- Remove the screw from the nut.

## STEP 35 Installing the basic board



- Use the same procedure for both slots in the Basic Board Cover.

## STEP 36 Connecting the filtration cable

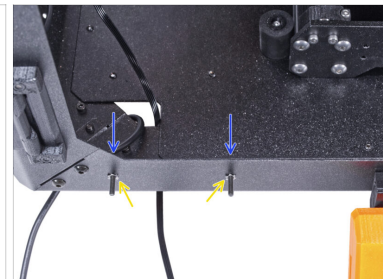
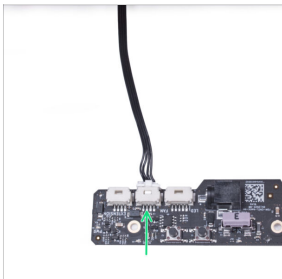
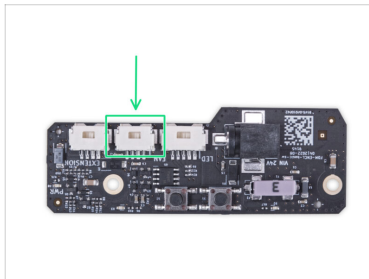

- Connect the filtration cable to connector on the basic board.
- From inside the enclosure, insert two M3x12 screw through the front profile.
- Attach two M3w serrated lock washer on the screws.

## STEP 37 Mounting the basic board

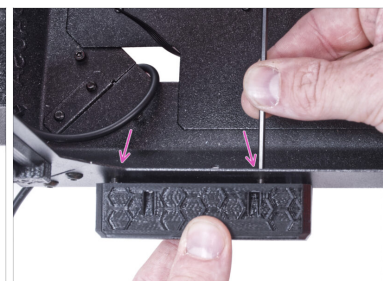
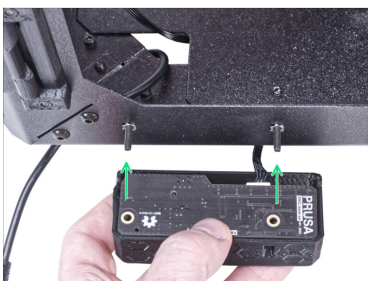

- Insert the basic board into the Basic Board Cover and align the holes on both parts.
- Take the basic board assembly and align the holes with the screws in the profile.
- Attach the basic board assembly to the screws and tighten the screws from the inside.



### STEP 38 Connecting the external PSU

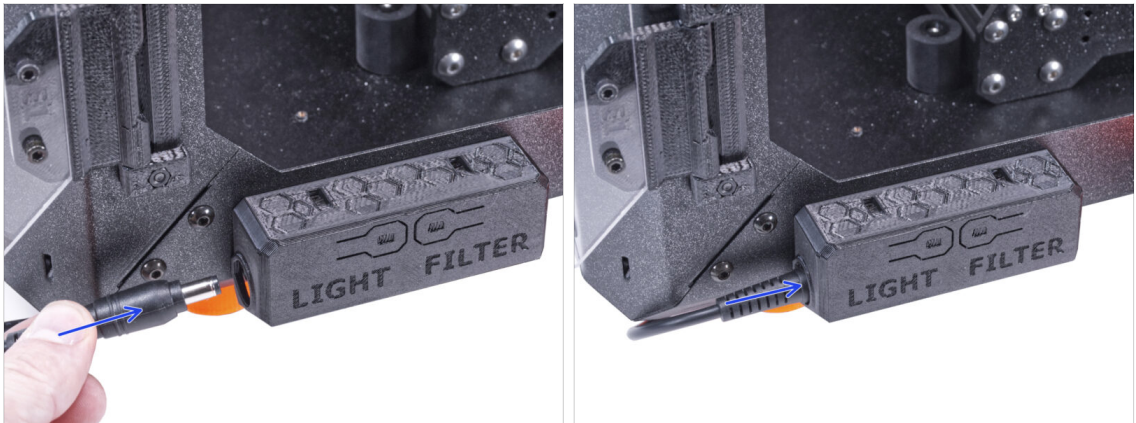

- Connect the external PSU cable to the basic board from the left side.

### STEP 39 Connecting the Power cord: parts preparation



- For the following steps, please prepare:
- Power cord Y-splitter (1x)

## STEP 40 Connecting the Power cord

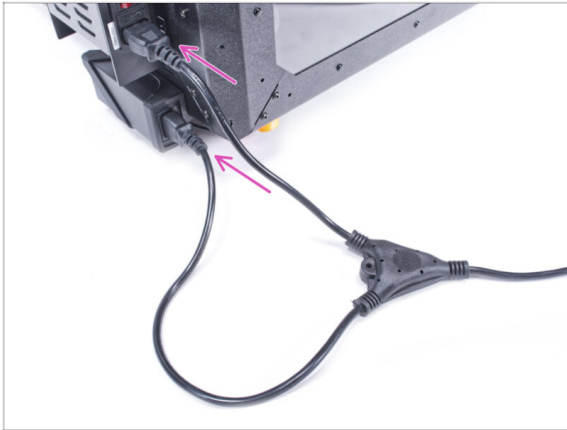

- ◆ Connect the cord plugs to the external PSU and printer PSU.
- ⓘ The order of connection does not matter.

## STEP 41 Well done!

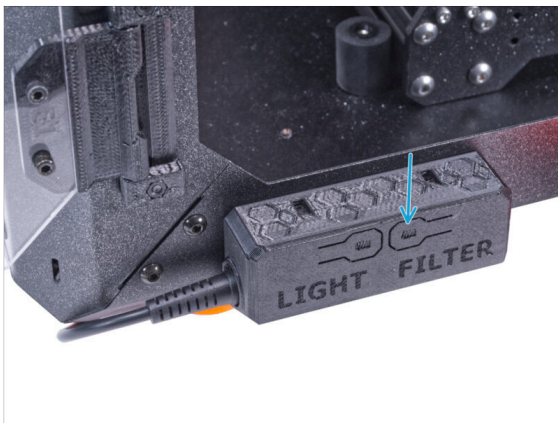

- ◆ Check if it works properly. Press the FILTER button on the Basic Board Panel and check if the filter fan is spinning. Keep the enclosure door open, the fan can be easily heard.
- ◆ **Good job!** The Advanced filtration system is successfully installed.
- ⓘ The following steps are for installing the Advanced filtration system with the External PSU XP Power model VEC65US24.

## STEP 42 Introduction - External PSU XP Power



- ◆ The following instructions are intended for installing the **Advanced filtration system** with the **External PSU XP Power model VEC65US24** on the **Original Prusa Enclosure**.
- ◆ **Before you start installing the add-on, PRINT OUT ALL NECESSARY PLASTIC PARTS!** The *External-PSU-bracket-XP* and the *Basic-board-cover* are available for download at [Printables.com](https://www.printables.com)
- ⓘ Note: the *External-PSU-bracket-XP* is intended for mounting the external PSU to the enclosure. However, it is not necessarily required.

## STEP 43 Tools necessary for this chapter

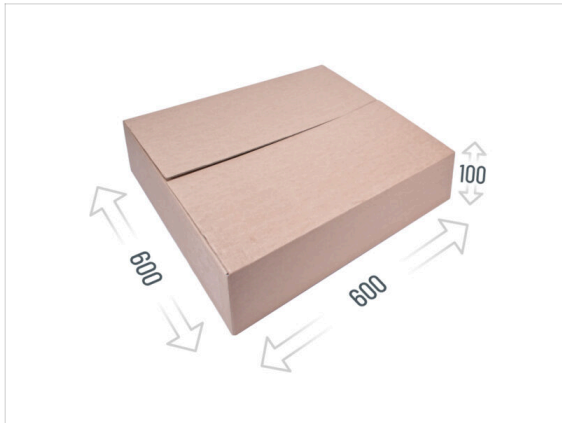
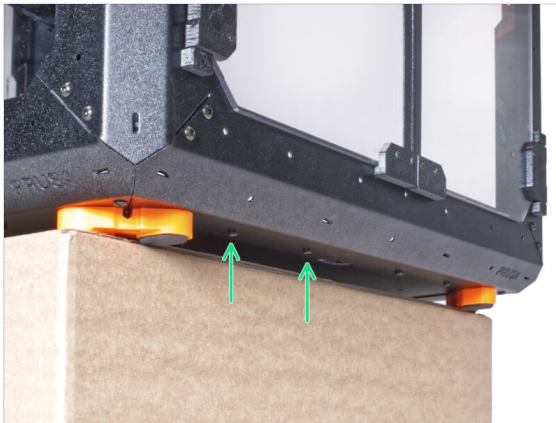

- ⓘ Tools are not included in the add-on package.
- ◆ **For this chapter, please prepare:**
- ◆ 2.5mm Allen key
- ◆ Needle-nose pliers (*to trim the zip ties*)
- ◆ Piece of cloth or fabric at least 15 x 15 cm

**STEP 44** Suggestion

- ◆ In the following steps, you will need to access the bottom of the enclosure. You achieve this by having one of the bottom edges of the frame extend beyond the work surface. It is recommended to use a cardboard box and put the enclosure on it.
- ◆ The size of the box must be at least 600 x 600 x 100 mm.
- i Hint: you can use the original cardboard box of the Enclosure packaging.
- ⚠ Do not place the enclosure on the box now. Wait for the instruction.

**STEP 45** Mounting the external PSU (optional): parts preparation

- i Note: the External-PSU-bracket-XP is intended for mounting the external PSU to the enclosure. However, it is not necessarily required. If you do not want to install the External PSU bracket, go to [Removing the LCD](#).
- ◆ **For the following steps, please prepare:**
  - ◆ External PSU XP Power (1x)
  - ◆ M3x8 screw (1x)
  - ◆ M3nS nut (1x)
  - ◆ External-PSU-bracket-XP (1x)

### STEP 46 Mounting the external PSU (optional)



- Insert the M3nS nut into the External-PSU-bracket-XP. Using the Allen key, push the nut all the way into the printed part and align the nut with the hole in the part.

### STEP 47 Assembling the external PSU bracket (optional)



- Insert the external PSU into the External-PSU-bracket-XP and push it all the way in. Mind the correct orientation of the PSU.
- Guide the external PSU cable through the channel in the bracket.

## STEP 48 Removing the LCD



- Carefully cut the zip tie securing the LCD cable bundle.
- Release two screws mounting the LCD assembly.
- Disconnect both LCD cables from the LCD.
- Push the LCD cable bundle through the hole in the bottom panel into the enclosure.

## STEP 49 Removing the printer

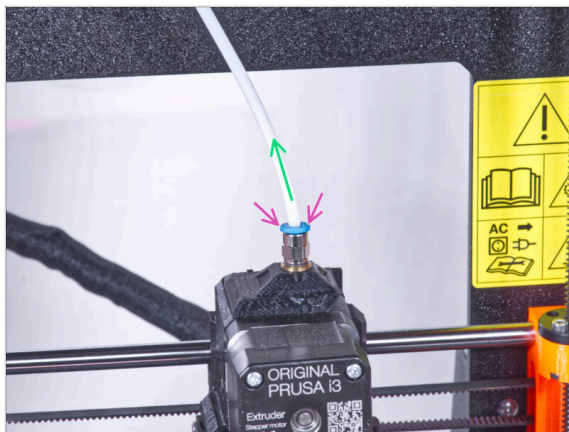

- ⓘ Starting from September 2024, you may receive a new black Fitting M5-4. The assembly and functionality remain identical to the blue one.
- Press down the blue collet on the Fitting QSM-M5.
- Pull out the PTFE tube from the fitting.

## STEP 50 Removing the printer

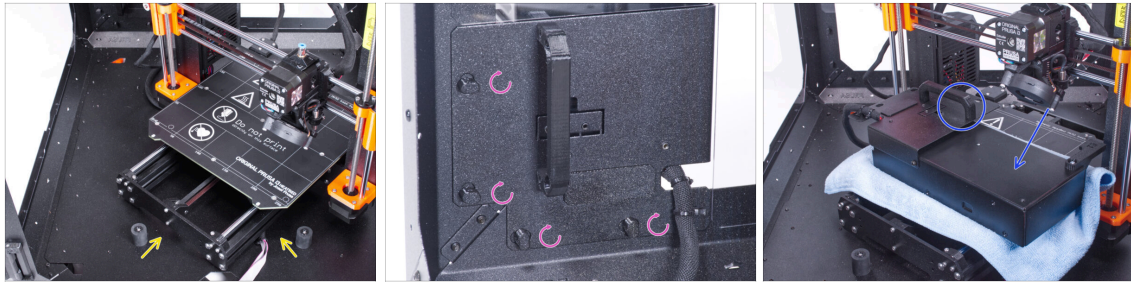

- ◆ Open the door of the enclosure.
- ◆ Place the printer at an angle (as shown in the picture) in the enclosure behind the anti-slip dampers.
- ◆ "Unlock" all PSU-locks and grasp the PSU assembly by its handle and remove it from the back panel.
- ◆ Place the PSU on the heatbed protected with the cloth. Turn it with the PSU-handle facing upwards.

## STEP 51 Removing the printer

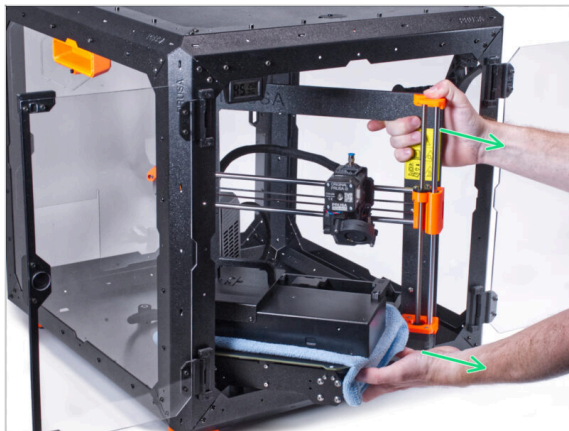

- ◆ Carefully remove the printer from the enclosure.
- ⚠ **Avoid scratching the printer and enclosure.**
- ◆ Place the printer aside. We will need it later on.

## STEP 52 Loosening the bottom panel

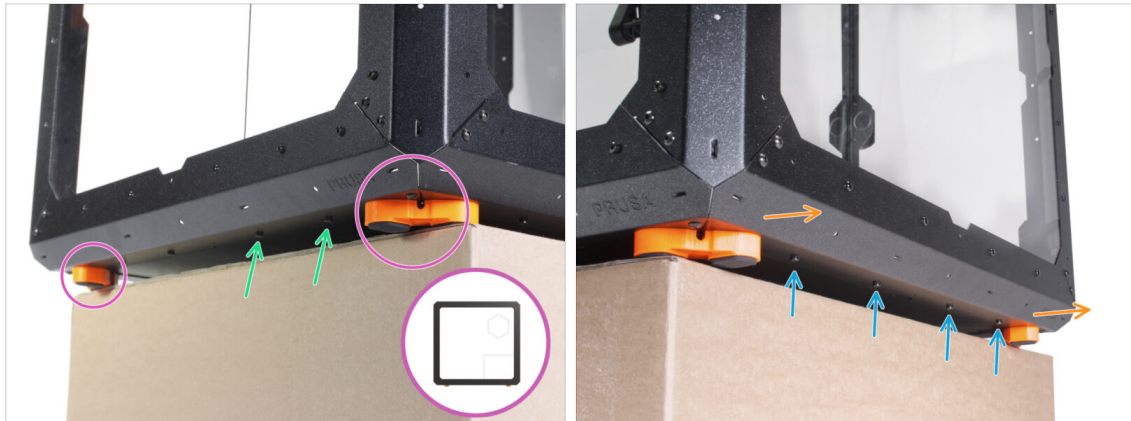

- Place the enclosure on the cardboard box with the rear side (side with the PSU hole in the back panel) overhanging the box.
- It is necessary that both feet on the left side stand on one anti-vibration pad. See the detail. **Avoid placing the enclosure directly on the frame.**
- ⚠ **WARNING: Be extra careful and make sure the enclosure is stable and doesn't wobble. Otherwise, the enclosure may fall off the box and hurt you and damage.**
- From the bottom, release and remove two screws nearest the right corner.
- In the same way, move the enclosure so that the right side overhangs the box.
- Release and remove four screws from the bottom profile.
- Place the enclosure so that all feet are on the surface.

## STEP 53 Mounting the external PSU



- From the inside, push the M3x8 screw through the hole in the bottom profile next to the PRUSA logo.
- Line up the screw hole in the External-PSU-bracket-XP with the protruding screw and attach it to the profile.
- Tighten the M3x8 screw from inside to mount the external PSU.



## STEP 54 Guiding the external PSU cable

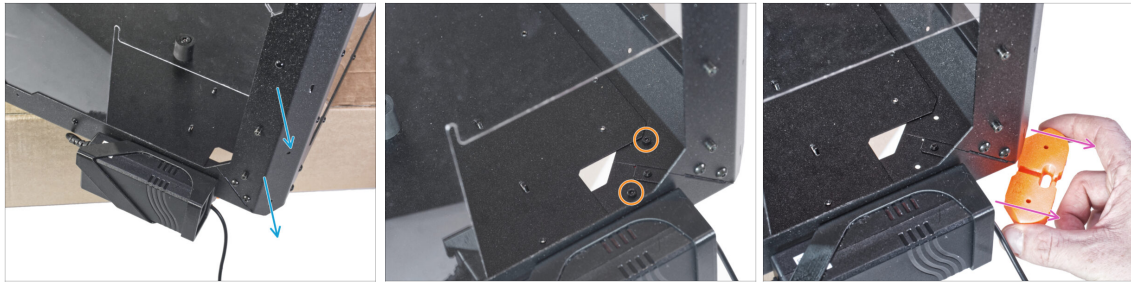

- ◆ Move the rear corner with the PSU over the edge of the box.
- ◆ Through the rectangular hole in the back panel, release two screws mounting the foot to the bottom panel.
- ◆ Remove the foot from the bottom of the enclosure. **Do not discard the part, you will need it again in a while.**

## STEP 55 Guiding the external PSU cable

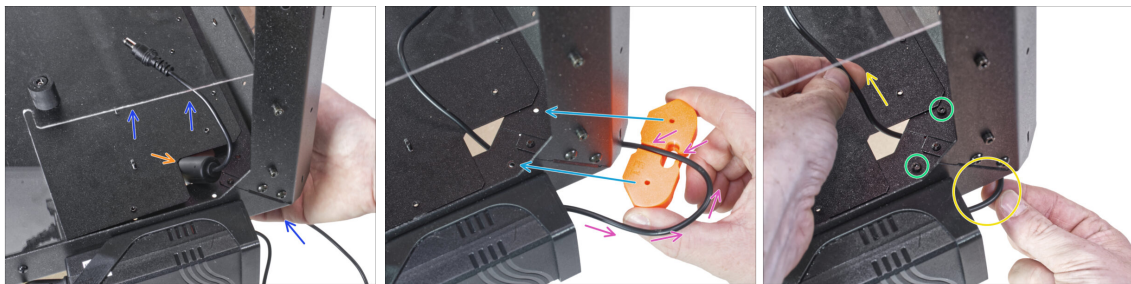

- ◆ Slightly lift the bottom panel from the bottom side.
- ◆ From the bottom side, push the PSU cable with the ferrite bead (cylindrical part) through the hole in the bottom panel into the enclosure.
- ◆ Guide the PSU cable through the channel in the feet bracket. See the correct orientation of the part.
- ◆ Maintain the orientation of the feet bracket and attach it to its place on the bottom of the enclosure. Line up the holes in the part with the hole in the bottom frame of the enclosure.
  - ◆ Make sure the cable has not fallen out of the channel.
- ◆ Secure the feet bracket with two M3x12 screws.
- ◆ Gently pull the cable back and forth to check for pinching. Keep the excess cable as shown in the picture.

## STEP 56 Tightening the bottom panel

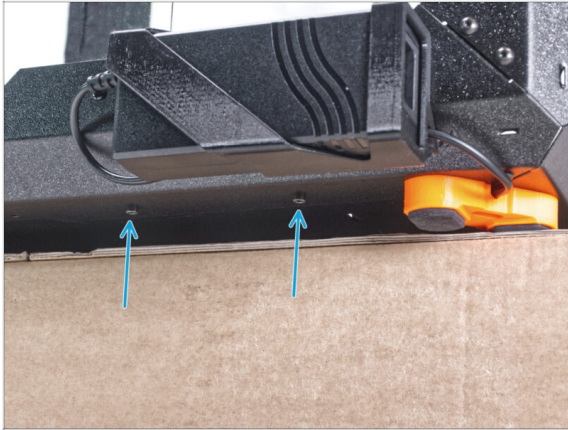

- Overhang the rear side of the enclosure over the box or table. It is necessary that both feet on the rear side stand on one anti-vibration pad. **Avoid placing the enclosure directly on the frame.**

**⚠ WARNING: Be extra careful and make sure the enclosure is stable and doesn't wobble.** Otherwise, the enclosure may fall off the box and hurt you and damage.

- Secure the bottom panel with two M3x4 screws from the bottom.
- Place the enclosure so that all feet are on the surface.

## STEP 57 Loosening the bottom panel



- Place the enclosure on the cardboard box with the front side overhanging the box.
- It is necessary that both feet on the front side stand on one anti-vibration pad. **Avoid placing the enclosure directly on the frame.**
- From the bottom, release first two screws from the left.
- Move the left front corner over the edge of the box or table.

## STEP 58 Guiding the external PSU cable

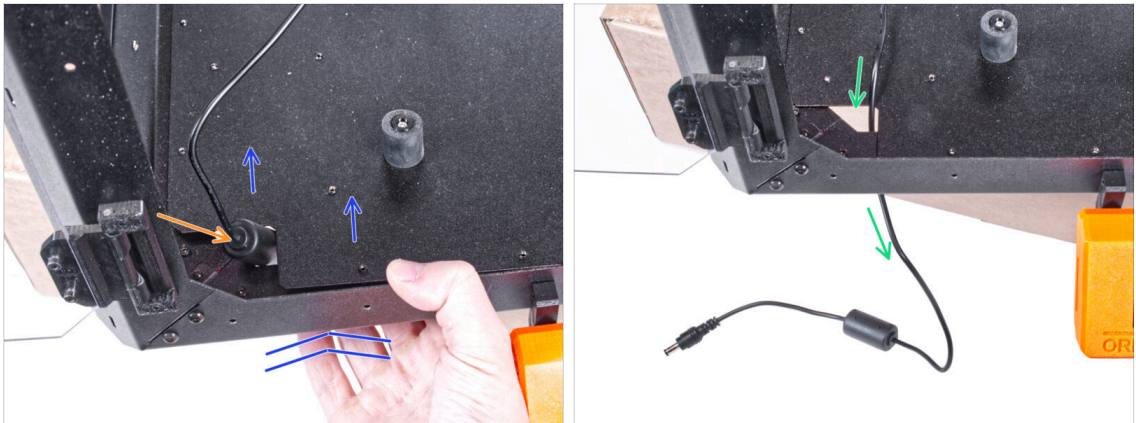

- ◆ Slightly lift the bottom panel from the bottom side.
- ⚠ **Be very careful not to pinch your fingers.**
- 🟠 Push the ferrite bead (cylindrical part) on the external PSU cable through the hole.
- 🟢 Guide the external cable through the hole and leave it free for now.

## STEP 59 Guiding the external PSU cable



- ◆ Release two screws mounting the feet bracket.
- ◆ Remove the feet bracket from the bottom of the enclosure.
- ◆ There is a cable channel in the feet bracket. Guide the external PSU cable through the channel. Mind the correct orientation of the part.

## STEP 60 Guiding the external PSU cable

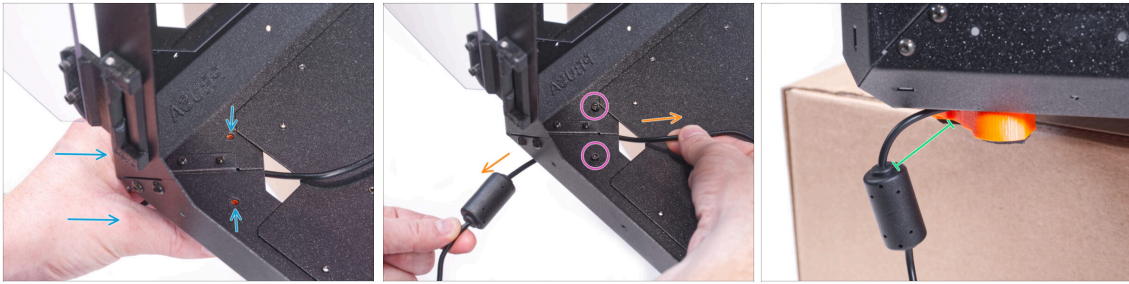

- ◆ Maintain the orientation of the feet bracket and attach it to its place on the bottom of the enclosure. Line up the holes in the part with the hole in the bottom frame of the enclosure.
- ◆ Make sure the cable has not fallen out of the channel.
- ◆ Secure the feet bracket with two M3x12 screws.
- ◆ Gently pull the cable back and forth to check for pinching.
- ◆ Leave the cable extended as shown in the picture. Space between ferrite bead and the feet bracket between 2 - 5 cm.

## STEP 61 Tightening the bottom panel

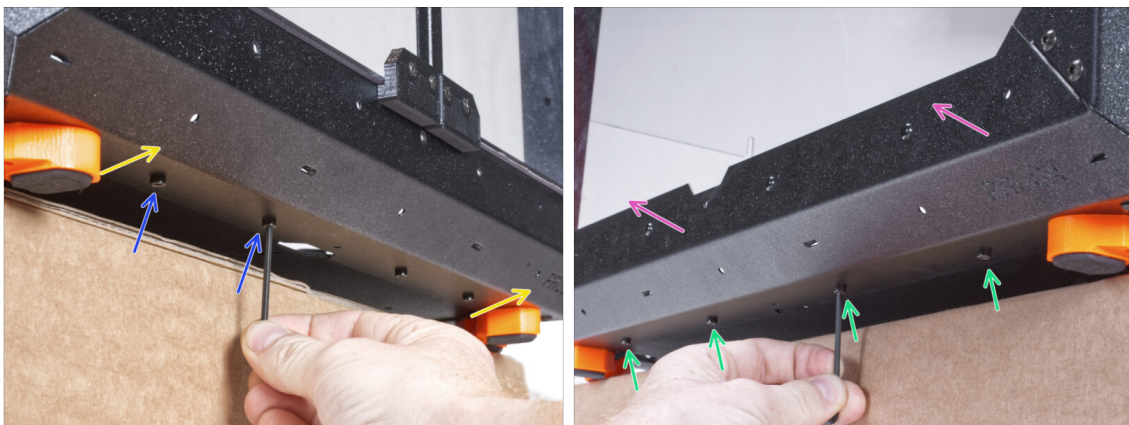

- ◆ Overhang the front side of the enclosure over the box or table. It is necessary that both feet on the front side stand on one anti-vibration pad. Avoid placing the enclosure directly on the frame.
- ◆ Secure the bottom panel with two M3x4 screws from the bottom.
- ◆ Overhang the left side of the enclosure over the box or table. It is necessary that both feet on the left side stand on one anti-vibration pad. Avoid placing the enclosure directly on the frame.
- ◆ Secure the bottom panel with four M3x4 screws from the bottom.
- ◆ Now, place the enclosure on all its feet on the work table and remove the cardboard box. We will not need it anymore.

## STEP 62 Assembling the filtration: parts preparation

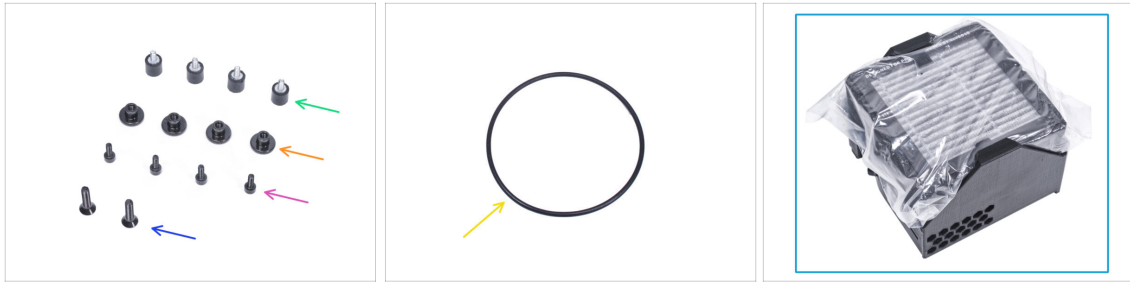

◆ For the following steps, please prepare:

- ◆ Damper (4x)
- ◆ Thumb nut M3 (4x)
- ◆ M3x8 screw (4x)
- ◆ M4x16b countersunk screw (2x)
- ◆ Blower o-ring
- ◆ Filtration pack (1x)

## STEP 63 Assembling the filtration: parts preparation



◆ Push out the filter from the filtration pack and **divide the pack into these individual parts:**

- ◆ High Pressure Blower (1x)
- ◆ HEPA filter (1x)
- ◆ Filter-Bracket (1x)

## STEP 64 Assembling the filtration

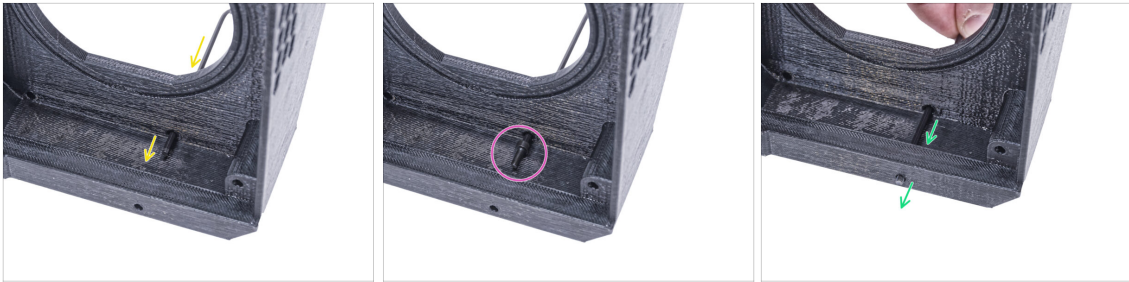

- Place the Filter-Bracket like in the picture and push the Allen key through the hole as you can see.
- Attach the M3x8 screw on the tip of the Allen key.
- Using the Allen key, push the screw all the way through the front hole of the bracket. The screw must protrude partially.

## STEP 65 Assembling the filtration



- Tighten the damper on the screw.
- Repeat the same procedure to install the second damper.

## STEP 66 Assembling the filtration

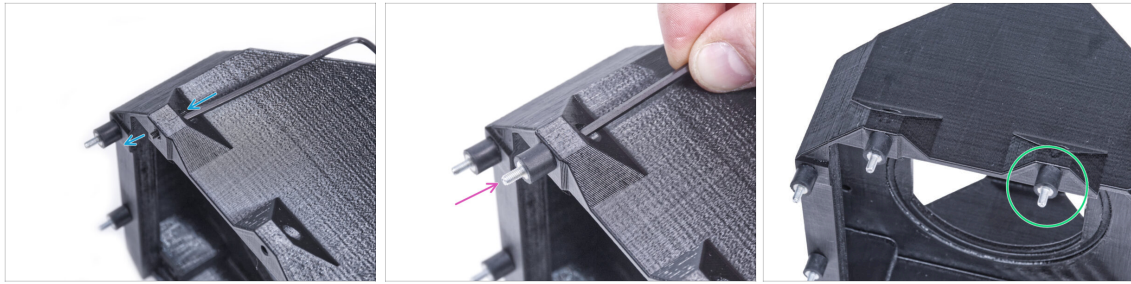

- Using the Allen key push the M3x8 screw through the protrusion on the other side of the Filter-Bracket.
- Tighten the damper on the screw.
- Repeat the same procedure to install the second damper.

## STEP 67 Installing the blower



- Place the Blower o-ring into the Filter-Bracket.
- Insert the High Pressure Blower into the Filter-Bracket so that the blower of the fan faces the hexagonal holes in the printed part.
- Join both parts together with two M4x16b countersunk screws.

## STEP 68 Inserting the HEPA filter



◆ Tear open the filter bag and remove the HEPA filter.

⚠ **Handle the filter with caution.** If the HEPA surface (the white pleated surface) is damaged, the filter will lose its efficiency. Protect your hands when you take off the used filter and put it in a plastic bag. A saturated filter is not recyclable.

## STEP 69 Inserting the HEPA filter



◆ Orient the filtration assembly according to the picture. Make sure that two brackets are facing you and the cable is pointing to the left.

⚠ **Make sure that the HEPA filter is already removed from the bag.**

◆ From the left, push the HEPA filter all the way into the Filter-Bracket. Mind the orientation of the filter.



## STEP 70 Installing the filtration

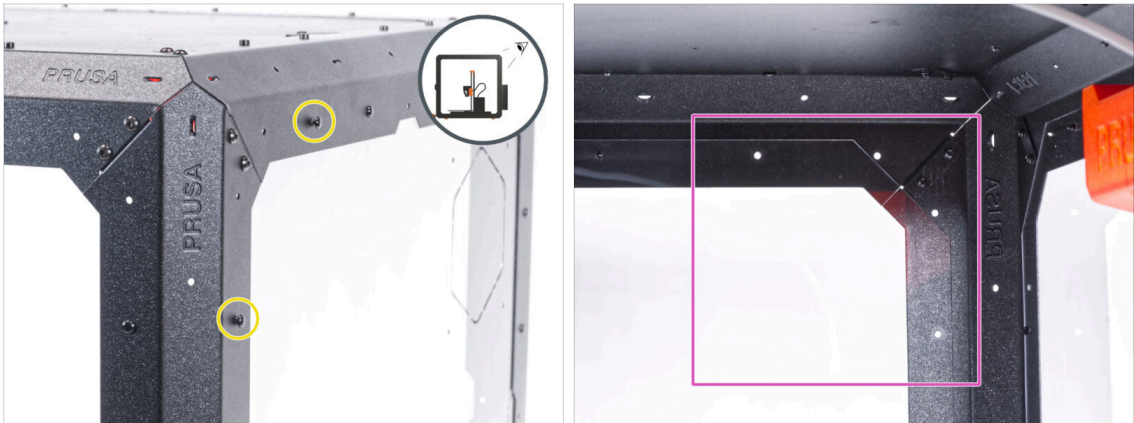

- On the rear side of the enclosure, pull out two nylon rivets on the top left corner.
- ⓘ From the inside, push on the nylon rivets using your thumb or the tip of the needle-nose pliers. When using the pliers, be careful not to damage the back panel and sheet metal profile.
- From the inside, focus on the rear top right corner. The area we will attach the filtration.

## STEP 71 Installing the filtration



- From inside, attach the filtration in the top right corner area so that the dampers are protruding through the holes in the rear profiles.
- From the rear side of the enclosure, secure the damper screws with four thumb nuts.
- To make sure, firmly tighten all thumb nuts with your hand.

## STEP 72 Guiding the filtration cable: parts preparation

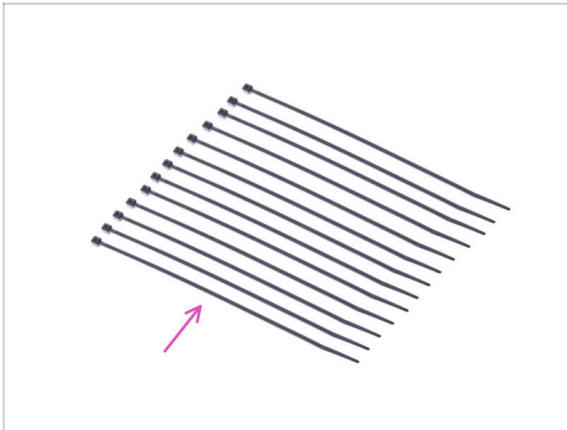

● For the following steps, please prepare:

● Zip tie (13x)

## STEP 73 Guiding the filtration cable



- Untie the filtration cable and leave it free.
- Push the zip tie through all three perforations on the top rear profile. Mind the orientation of the zip ties.
- Guide the filtration cable over the zip ties along the top profile.
- Secure the cable by tightening each zip tie.

⚠ **Do not overtighten the zip ties, you can damage the cable.**

## STEP 74 Guiding the filtration cable

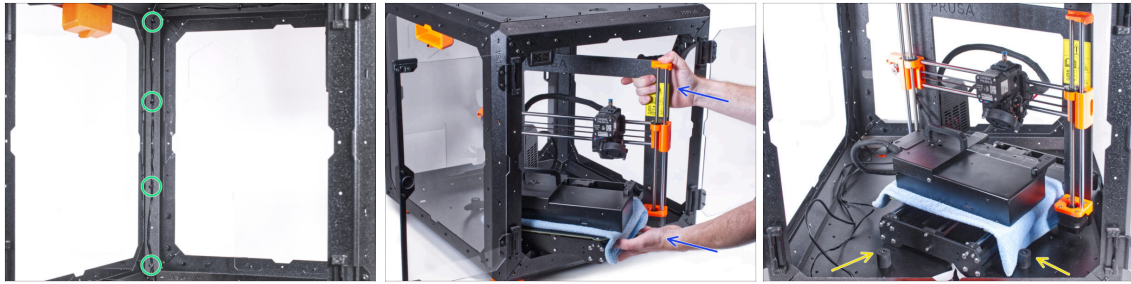

- ◆ In the same way, guide the filtration cable alongside the rear left support profile and secure it with four zip ties.
  - ⚠ **Do not overtighten the zip ties, you can damage the cable.**
- ◆ Insert the printer into the enclosure. To get the printer into the enclosure, insert its left side first.
  - ⚠ **Avoid scratching the side panels with the printer!**
- ◆ Place the printer at an angle (as shown in the picture) in the enclosure behind the anti-slip dampers.
  - ⓘ It's just a temporary position for the printer. We will adjust the correct position later.

## STEP 75 Installing the PSU



- ◆ Ensure the PSU-locks are still turned at the same position:
  - ◆ **On the bottom frame**, turn the PSU-locks to the horizontal position.
  - ◆ **On the support**, turn the PSU-lock to the vertical position.
- ◆ Push the PSU through the opening in the back panel.
- ◆ Attach the PSU-holder on the all PSU-locks.
- ◆ Turn all PSU-lock 90° to lock the PSU assembly.

## STEP 76 Guiding the cables



- Push three zip ties through the perforation in the bottom left profile.
- Make a loop with the PSU cable according to the picture.
- Merge the filtration cable and the PSU cable and guide them together. Secure both cables with the first zip tie on the bottom profile.
- Guide the cable along the bottom profile over the zip ties and tighten two remaining zip ties.

## STEP 77 Guiding the filtration cable



- Guide the filtration cable through the hole in the bottom panel out of the enclosure.
- Make a small loop with the external PSU cable.
- Secure the PSU cable with the zip tie to the perforation on the bottom profile.
- ⚠ **Do not overtighten the zip ties, you can damage the cable.**

**STEP 78** Mounting the LCD: parts preparation

◆ For the following steps, please prepare:

- ◆ LCD assembly (1x)
- ◆ M3x8 screw (2x)
- ◆ Zip tie (1x)

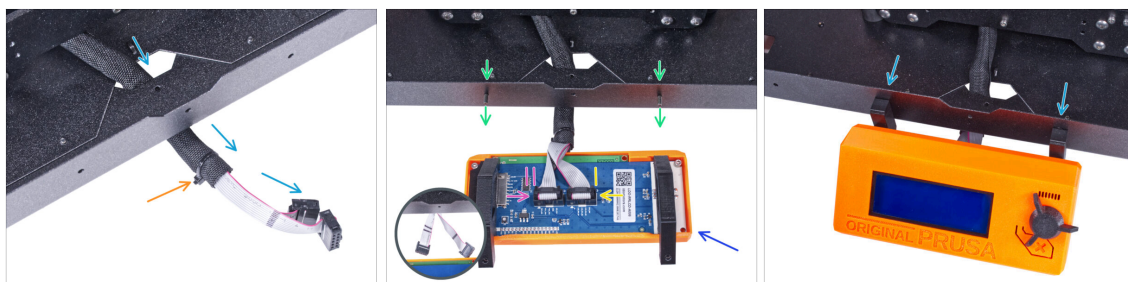
**STEP 79** Mounting the LCD

- ◆ Guide the LCD cable through the cutout in the bottom panel.
- ◆ Secure the textile sleeve on the cable bundle with the zip tie. **Do not over tighten the zip tie**, it may cut the cables!
- ◆ From the inside, push two M3x8 screws through the bottom profile.
- ◆ Place the LCD assembly close to the LCD cables, like in the picture. Mind the same orientation of the LCD as in the picture. See the LCD-supports for better understanding.

⚠ **Note that both cables are marked with stripes on one side. Correct connection order is important!**

- ◆ Connect the LCD cable marked with **TWO STRIPES** to the **left slot** (called EXP2) on the LCD controller.
- ◆ Connect the LCD cable marked with **ONE STRIPE** to the **right slot** (called EXP1) on the LCD controller.
- ◆ Slide the LCD assembly onto the two M3x8 screws in the frame and tighten them.

## STEP 80 Securing the LCD cable

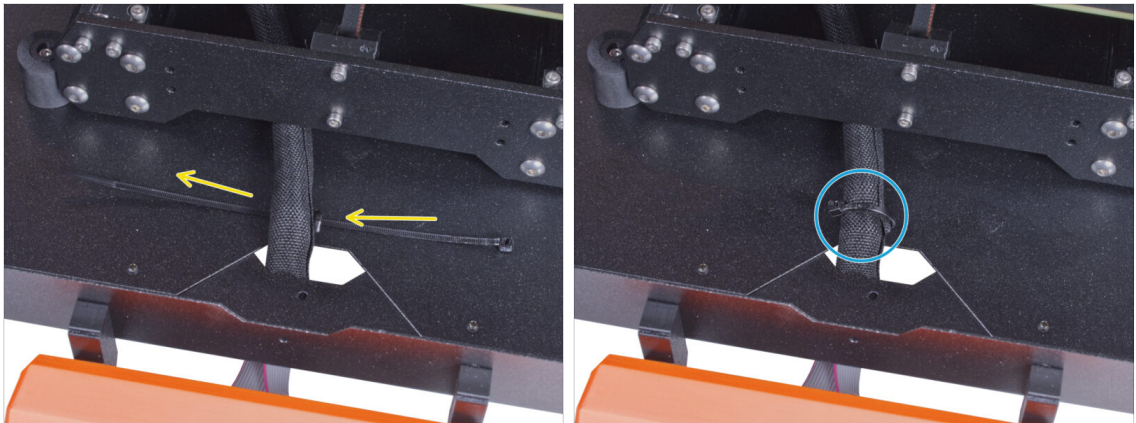

- Guide the zip tie through the perforation in the bottom panel and under the LCD cable bundle.
- Tighten the zip tie to secure the LCD cable bundle. **Do not over tighten the zip tie**, it may cut the cables!

## STEP 81 Installing the basic board: parts preparation



- **For the following steps, please prepare:**
- Basic-Board-Cover (1x)
  - Basic board (1x)
  - M3x12 screw (2x)
  - M3w serrated lock washer (2x)
  - M3nS nut (2x)

## STEP 82 Installing the basic board



- ◆ Mount the M3nS nut on the M3x12 screw. Attach it in a few threads on the tip of the screw.
- ◆ Push the screw with the nut all the way into the same shape hole inside the Basic-Board-Cover.
- ◆ Remove the screw from the nut.

## STEP 83 Installing the basic board



- ◆ Use the same procedure for both slots in the Basic-Board-Cover.

## STEP 84 Connecting the filtration cable

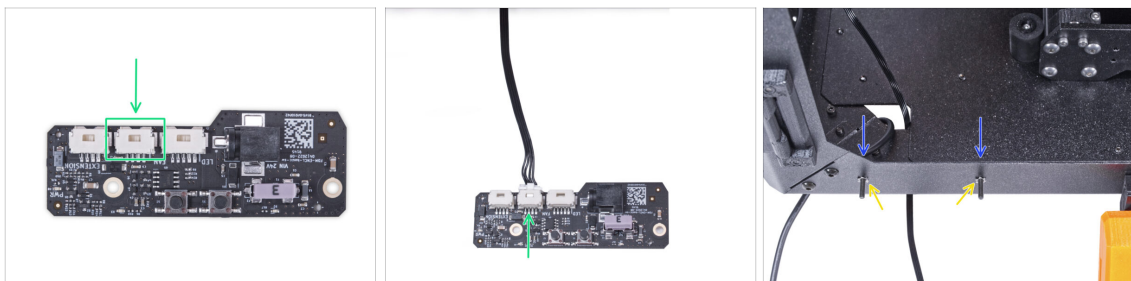

- ◆ Connect the filtration cable to connector on the basic board.
- ◆ From inside the enclosure, insert two M3x12 screw through the front profile.
- ◆ Attach two M3w serrated lock washer on the screws.

## STEP 85 Mounting the basic board

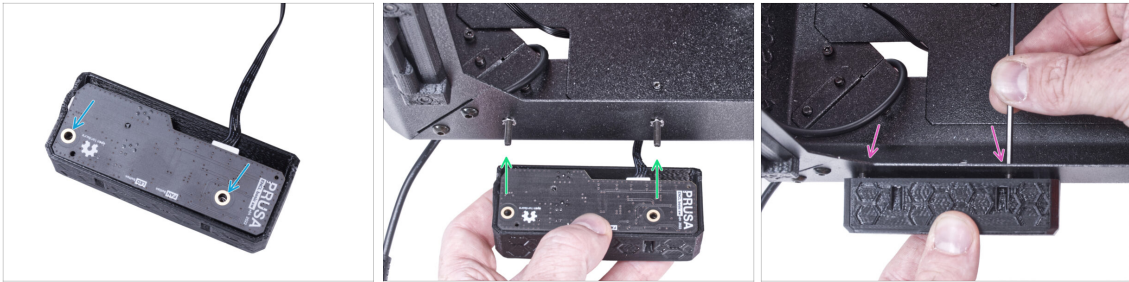

- ◆ Insert the basic board into the Basic-Board-Cover and align the holes on both parts.
- ◆ Take the basic board assembly and align the holes with the screws in the profile.
- ◆ Attach the basic board assembly to the screws and tighten the screws from the inside.

## STEP 86 Connecting the external PSU

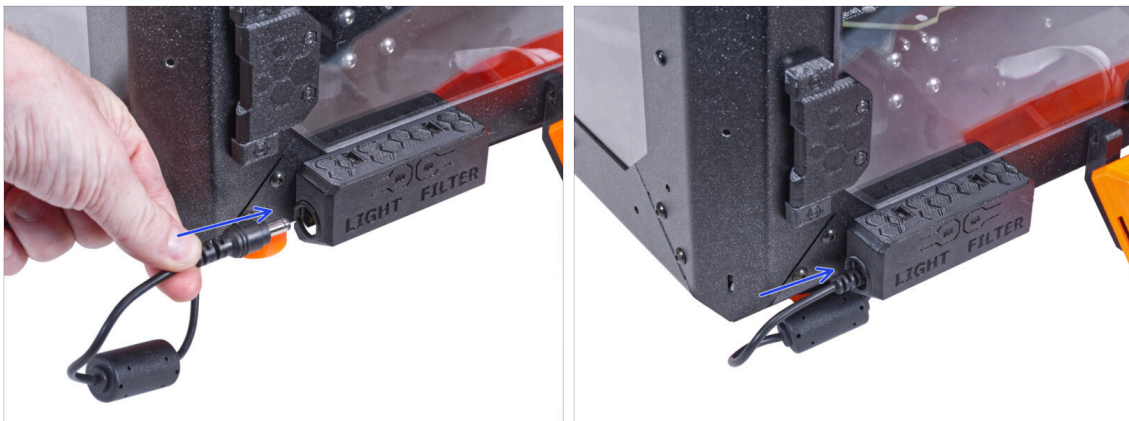

- ◆ Connect the external PSU cable to the basic board from the left side.



## STEP 87 Connecting the PTFE tube

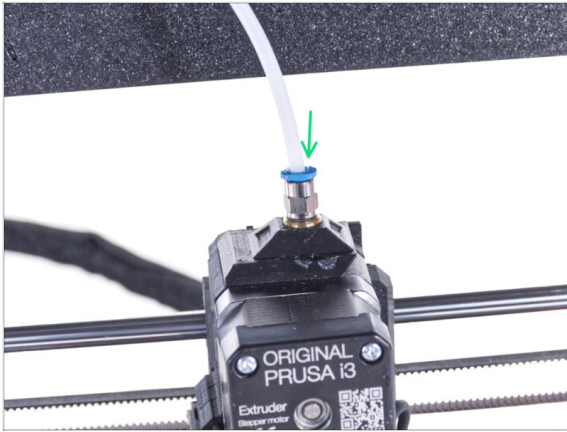

- ⓘ Starting from September 2024, you may receive a new black Fitting M5-4. The assembly and functionality remain identical to the blue one.
- ◆ Insert the free end of the PTFE tube to the Fitting QSM-M5 on the extruder. Insert it all the way down.

## STEP 88 Connecting the Power cord: parts preparation



- ◆ **For the following steps, please prepare:**
- ◆ Power cord Y-splitter (1x)

## STEP 89 Connecting the Power cord

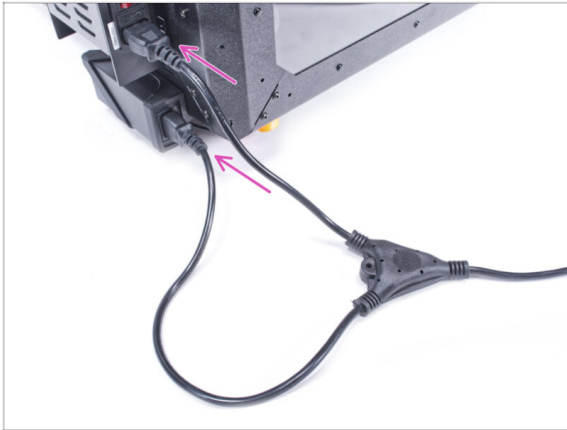

- ◆ Connect the cord plugs to the external PSU and printer PSU.
- ⓘ The order of connection does not matter.

## STEP 90 Well done!



- ◆ Check if it works properly. Press the FILTER button on the Basic Board Panel and check if the filter fan is spinning. Keep the enclosure door open, the fan can be easily heard.
- ◆ **Good job!** The Advanced filtration system is successfully installed.

## 8. Mechanical lock (add-on)

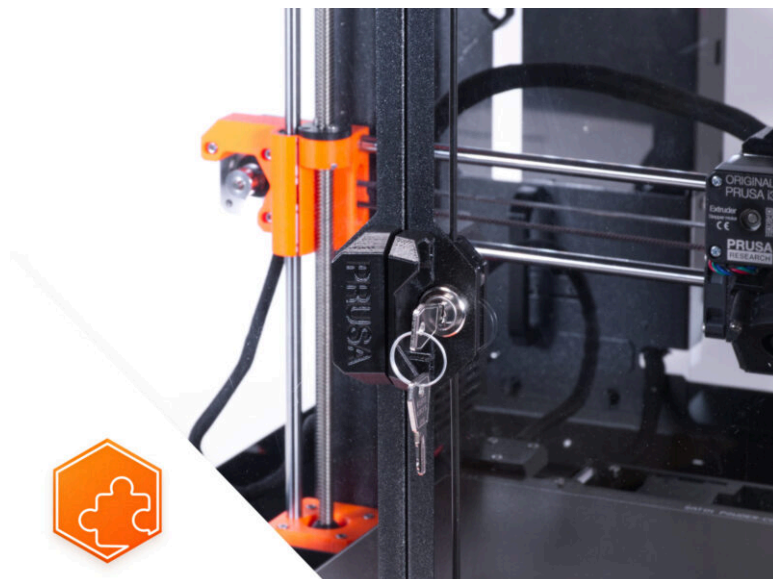

## STEP 1 Introduction



- ◆ This guide will take you through the installation of the **Mechanical lock** on the **Original Prusa Enclosure**.
- ⓘ The supplied fasteners contain extra spare parts.
- ◆ All printable parts are available for download at [Printables.com](https://www.printables.com) in case a part is damaged or missing.

## STEP 2 Tools necessary for this chapter

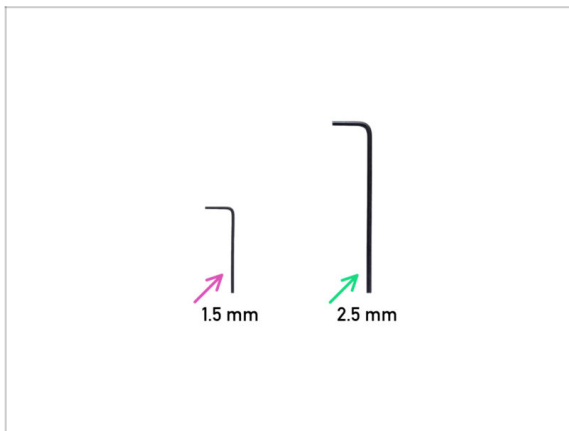

- ◆ **For this chapter, please prepare:**
- ◆ 1.5mm Allen key
- ◆ 2.5mm Allen key *not included in the add-on package*

### STEP 3 Removing the door panel



◆ Open the right door panel and release all four screws on the hinges.

◆ Remove the door panel.

⚠ **Avoid scratching the door panel during handling.**

ⓘ For the following steps, it is recommended to use a piece of cloth or any soft material as a mat to protect the door panel against scratches.

### STEP 4 Disassembling the door panel

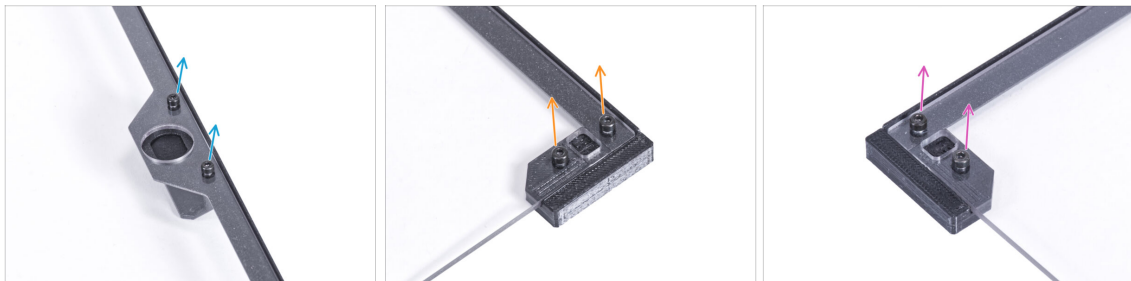

ⓘ It is recommended to put the door panel on a piece of cloth or any soft mat.

◆ On the door panel, release two screws securing the door handle and remove it from the panel.

◆ Remove two screws mounting the Door magnet A and remove it from the panel.

◆ Remove two screws mounting the Door magnet B and remove it from the panel.

◆ Remove the door panel from the door trim.

## STEP 5 Assembling the lock insert: parts preparation



◆ For the following steps, please prepare:

- ◆ Lock housing nut (1x)
- ◆ Lock housing (1x)
- ◆ Door trim (1x) *you removed earlier*
- ◆ Lock wrench (1x)

## STEP 6 Assembling the lock housing

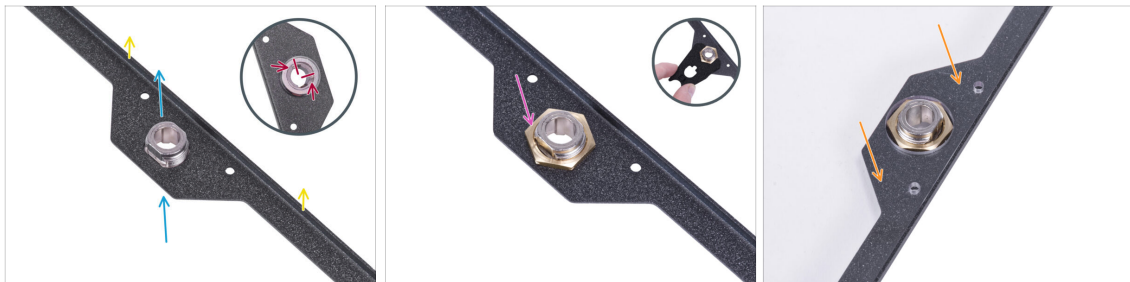

- ◆ Orient the door trim like in the picture. The bent edge of the trim must be facing up.
- ◆ Insert the lock housing into the same shape opening from the underside.
- ◆ From the opposite side, orient the lock housing according to the first picture. Use the notches in the housing for better orientation.
- ◆ Secure the lock housing by tightening the lock housing nut. Use the lock wrench for easier tightening.
- ◆ Place the door panel on the door trim.

## STEP 7 Assembling the door holders: parts preparation

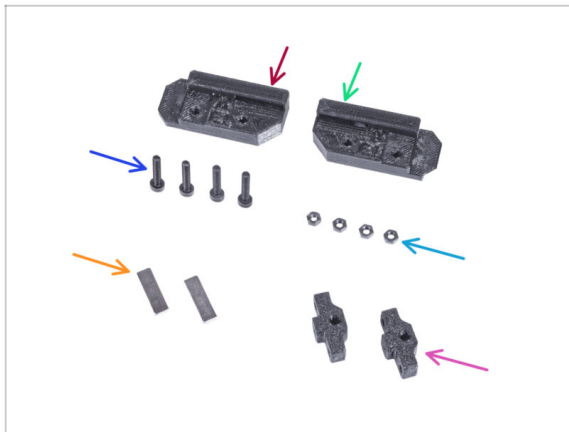

- For the following steps, please prepare:
- Lock Door Holder A (1x)
- Lock Door Holder B (1x)
- M3x18 screw (4x)
- M3n nut (4x)
- Magnet 20 x 6 x 2 mm (2x)
- Rod guide (2x)

## STEP 8 Assembling the door holders

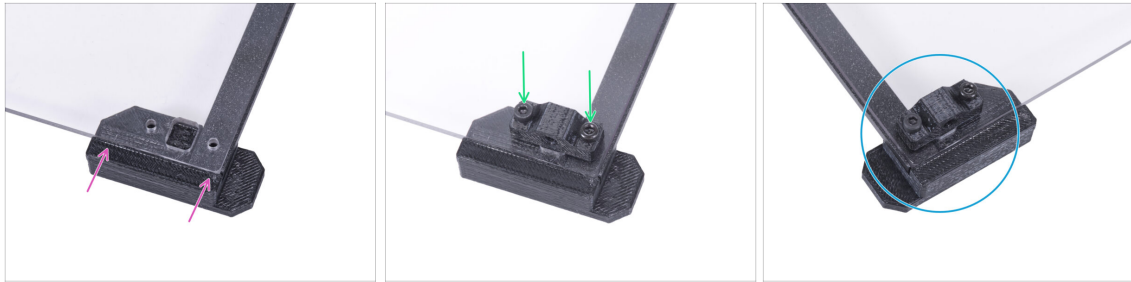

- Insert the magnet 20 x 6 x 2 mm into the pocket in the Lock Door Holder A.
- ⓘ The polarity or orientation of the magnet does not matter.
- Push the magnet all the way in. The magnet must be completely flush.
- Proceed the same with the second magnet and the Lock Door Holder B.
- Insert two M3n nut into each Lock Door Holder.

**STEP 9** Mounting the Lock Door Holders

**⚠ Do not overtighten the screws in the door panel! The panel could crack.**

- ◆ Attach the Lock Door Holder A from the underside to the door panel and the door trim. Align it with the panel edges.
- ◆ Mount the Rod guide to the panel and secure it with two M3x18 screws. The orientation of the part does not matter.
- ◆ Repeat the procedure with the top part (Lock Door Holder B).

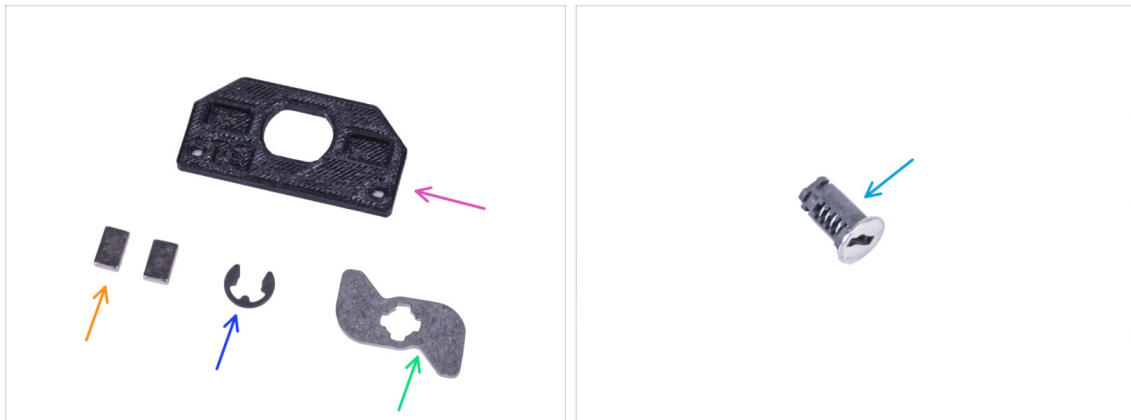
**STEP 10** Assembling the lock mechanism: parts preparation

◆ **For the following steps, please prepare:**

- ◆ Lock mount (1x)
- ◆ Magnet 10 x 6 x 2 mm (2x)
- ◆ E-clip washer (1x)
- ◆ Mechanical Lock Lever (1x)
- ◆ Lock (1x)



## STEP 11 Assembling the lock mechanism

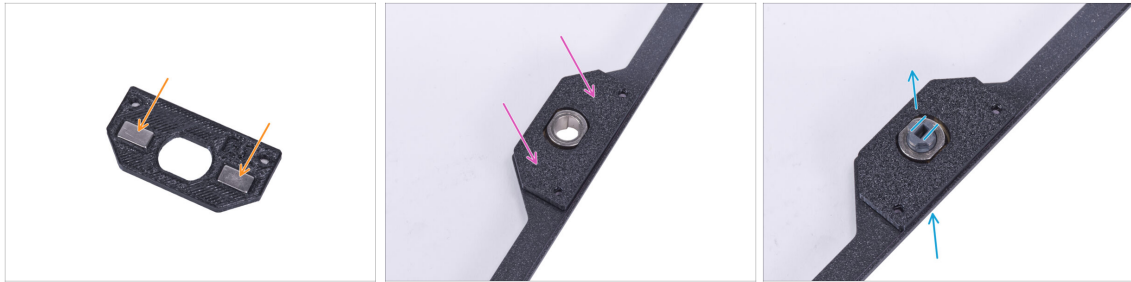

- ✦ Insert two magnets 10 x 6 x 2 into the pockets in the Lock mount. The orientation of the magnets does not matter.
- ✦ Attach the Lock mount on the door panel.
- ✦ From the underside, insert the Lock through the hole in the door panel assembly. See the correct orientation of the lock.

## STEP 12 Assembling the lock mechanism



- ✦ Attach the Mechanical Lock Lever on the lock. See the orientation of the part.
- ✦ Place E-clip washer on the Mechanical Lock Lever against the lock. Attach the Lock wrench on the lock and the washer.
- ✦ Using the Lock wrench, push the E-clip washer on the lock to secure the lock mechanism.

**STEP 13** Mounting the rods: parts preparation

● For the following steps, please prepare:

- Mechanical Lock Rod (2x)
- Spring 0.3 x 4 x 25 mm (2x)
- Rod fixing collar (2x)
- Key (2x)

ⓘ You can remove one of the keys from the ring and keep it as a spare.

**STEP 14** Mounting the rods

- Locate the groove on the Lock wrench. Place the rod next to groove.
- Slide the Rod fixing collar onto each rod. Do not tighten the grub screw yet.
- Attach the rod into the groove and move the rod fixing collar all the way to the Lock wrench edge.
- Tighten the grub screw in the rod fixing collar.
- Slide the spring on the rod.
- Proceed the same with the other rod.

---

### STEP 15 Mounting the rods



- ◆ Insert the key in the lock.
- ◆ Turn the key to "lock" the mechanism.
- ◆ From the opposite side, check if the orientation of the Mechanical Lock Lever is the same as in the picture.

---

### STEP 16 Mounting the rods



- ◆ Take one of the rod and insert the end with the spring into the "lower" Rod guide.
- ◆ Attach the "L" shaped end of the rod to the Mechanical Lock Lever with the same orientation as you can see in the picture.
- ◆ Compare the final look with the third picture.

### STEP 17 Mounting the rods



- Take the second rod and insert the end with the spring into the "higher" Rod guide.
- Attach the "L" shaped end of the rod to the Mechanical Lock Lever with the same orientation as you can see in the picture.

### STEP 18 Covering the lock mechanism: parts preparation

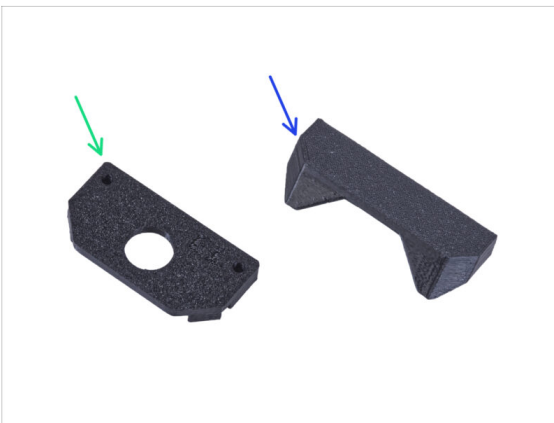

For the following steps, please prepare:

- Lock cover (1x)
- Handle with lock hole (1x)
- M3x18 screw (2x)
- M3ns nut (2x)

**STEP 19** Covering the lock mechanism

- ◆ Insert two M3nS nuts all the way into the Handle with lock hole.
- ◆ Attach the Handle with lock hole on the door trim from the side with the key. Align the holes in the Handle with the holes in the door panel.
- ◆ Hold the Handle with your hand.
- ◆ Attach the Lock cover on the lock mechanism.
- ◆ Secure all the parts with two M3x18 screws.

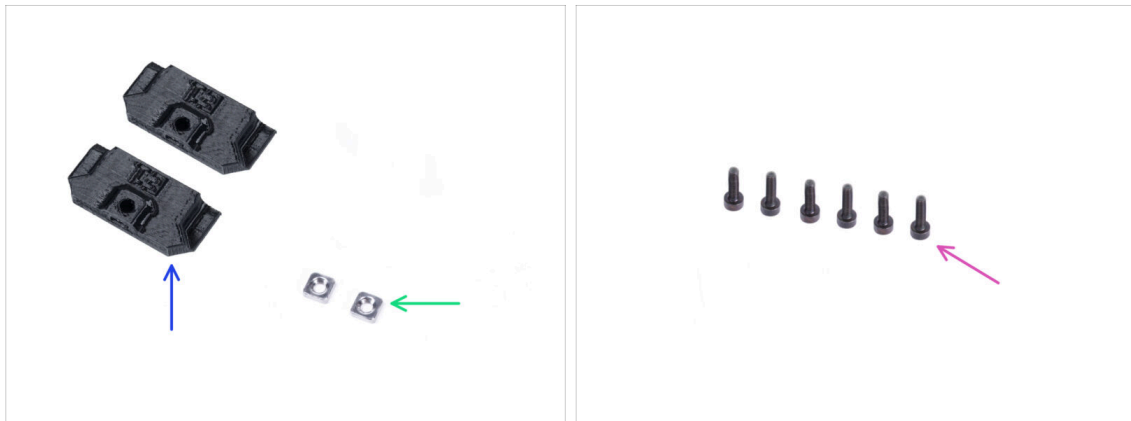
**STEP 20** Installing the rod latches: parts preparation

- ◆ **For the following steps, please prepare:**
- ◆ Rod latch (2x)
- ◆ M3nS nut (2x)
- ◆ M3x8 screw (6x)

## STEP 21 Installing the rod latches



- ◆ Insert the M3nS nut all the way into each Rod latch.
- ◆ Attach the Rod latch from inside to the cutout in the front bottom profile and secure it with the M3x8 screw.
- ◆ Attach the second Rod latch to the cutout in the front top profile and secure it with the M3x8 screw.

## STEP 22 Attaching the door panel



⚠ **Do not overtighten the screws in the door panel!** The panel could crack.

- ◆ Attach the door panel on the door hinges. **Make sure the handle is on the outside of the panel.**
- ◆ Secure the door assembly by tightening two M3x8 screws in each hinge.
- ◆ Turn the key and lock the door. Try to pull the "locked" door to ensure, that the lock is working properly.

**STEP 23** That's it!



- ◆ **Congratulations!** You just successfully installed the Mechanical lock.

## 9. Quick release PSU cable - MK3S+ Black PSU (add-on)

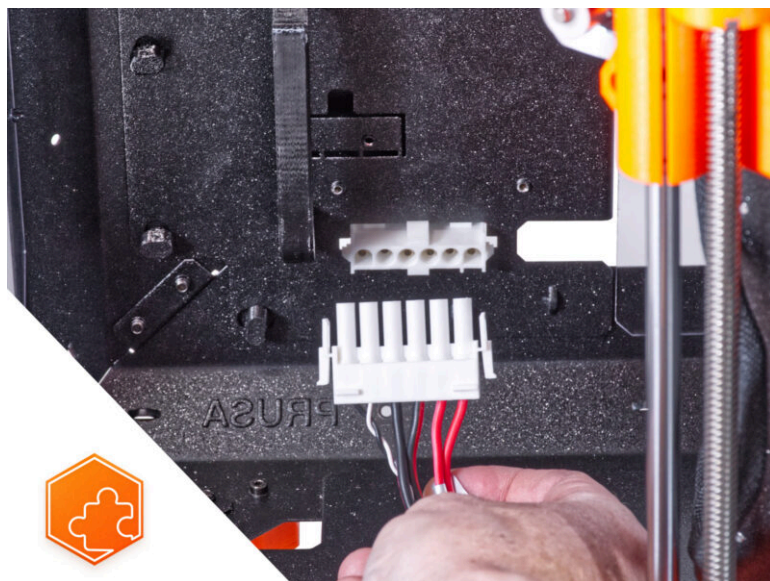



## STEP 1 Introduction

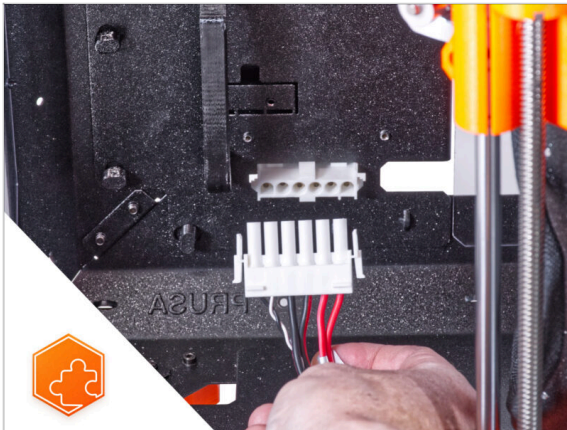

◆ This guide will take you through the installation of the **Quick release PSU cable** on the **Original Prusa Enclosure**.

⚠ **This add-on is not compatible with the Original Prusa MK4.**

⚠ **This add-on is not compatible with the silver PSU.**

ⓘ Buy a compatible black PSU from our [E-shop](#).

## STEP 2 Tools necessary for this chapter

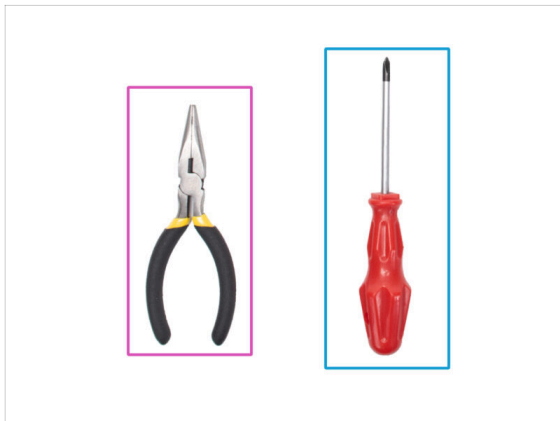
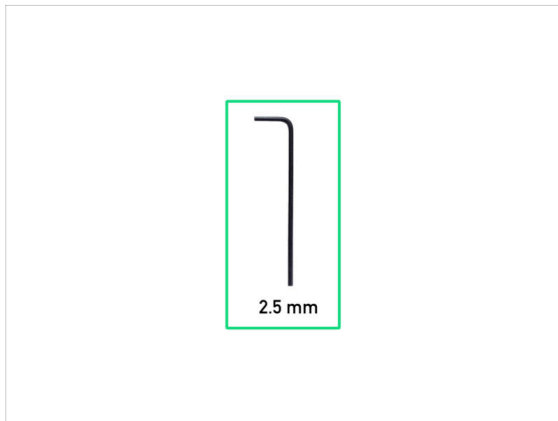

ⓘ Tools are not included in the add-on package.

◆ **For this chapter, please prepare:**

● 2.5mm Allen key

● Needle-nose or cutting pliers

● Phillips screwdriver PH2

### STEP 3 Removing the LCD



- ◆ Carefully cut the zip tie securing the LCD cable bundle.
- ◆ Release two screws mounting the LCD assembly.
- ◆ Disconnect both LCD cables from the LCD.
- ◆ Push the LCD cable bundle through the hole in the bottom panel into the enclosure.

### STEP 4 Removing the printer

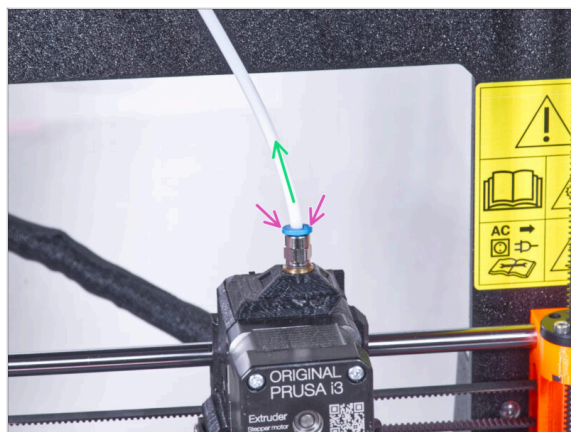

- ◆ Press down the blue collet on the Fitting QSM-M5.
- ◆ Pull out the PTFE tube from the fitting.

## STEP 5 Removing the printer

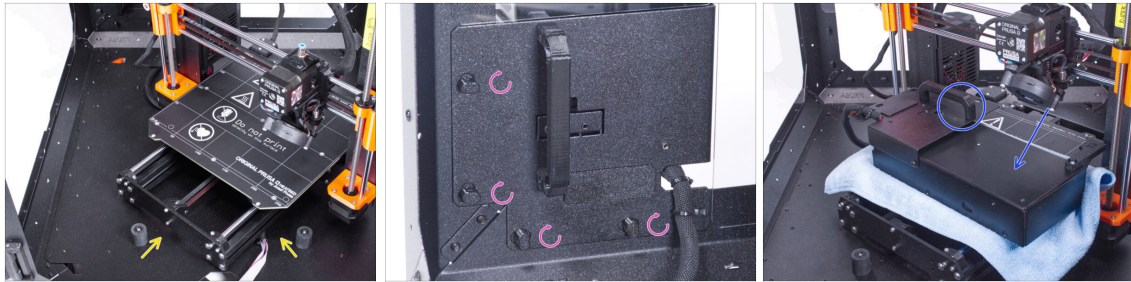

- ◆ Open the door of the enclosure.
- ◆ Place the printer at an angle (as shown in the picture) in the enclosure behind the anti-slip dampers.
- ◆ "Unlock" all PSU-locks and grasp the PSU assembly by its handle and remove it from the back panel.
- ◆ Place the PSU on the heatbed protected with the cloth. Turn it with the PSU-handle facing upwards.

## STEP 6 Removing the printer

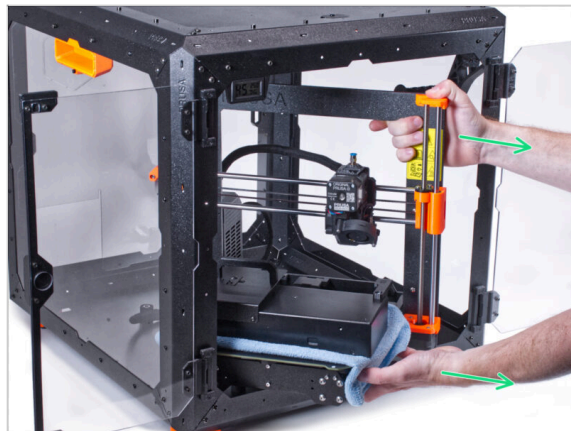

- ◆ Carefully remove the printer from the enclosure.
- ⚠ **Avoid scratching the printer and enclosure.**
- ◆ Place the enclosure aside. We will need it later on.

## STEP 7 Disconnecting the PSU



- ◆ On the PSU holder, cut off the zip tie securing the PSU cable.
- ◆ On the other side of the PSU assembly, loosen two screws mounting the PSU-cover and remove the cover from the PSU.
- ◆ Using a Phillips screwdriver, loosen all the screws on the PSU cables. **No need to remove the screws.**
- ◆ Remove all PSU cables from the terminals.
- ◆ Disconnect the power panic cable from the PSU.
- ◆ Place the disconnected PSU aside for now. We'll come back to that later.

## STEP 8 Disconnecting the PSU cables

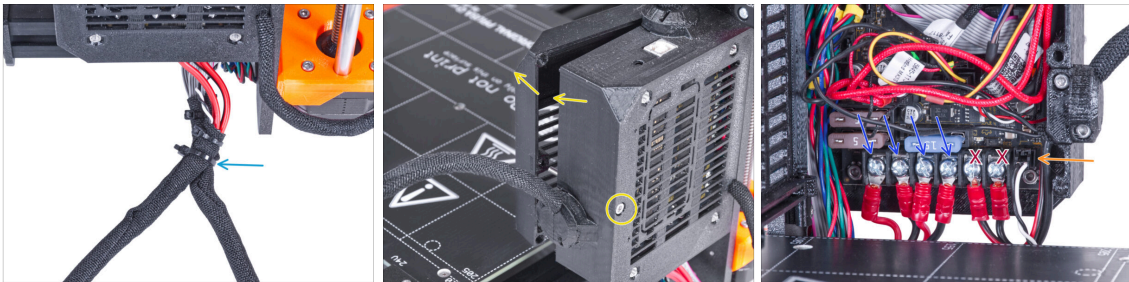

- ◆ Cut off the zip tie merging both cable bundles.
- ◆ From the back of the Einsky case, loosen the screw to open the door of the electronic box.
- ◆ Using the Phillips screwdriver, loosen the screws securing the PSU cables (the first four from the left). And remove all the cables from the terminals.
- ⚠ **Do not disconnect the heatbed power cables (the last two cables)!**
- ◆ Disconnect the Power panic cable from the electronics board.
- ◆ Keep the electronics box open.

## STEP 9 Disconnecting the PSU cables

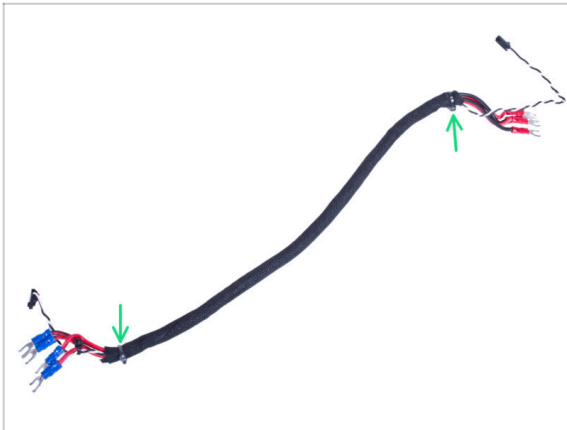

- Cut the zip ties on both ends of the textile sleeve and remove the sleeve from the cable bundle.
- ⓘ You will no longer need this cable bundle. However, we recommend not discarding it. Keep it as a spare.

## STEP 10 Installing the quick release cable: parts preparation

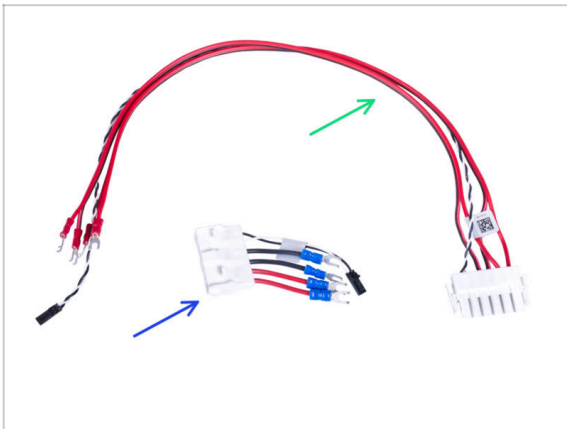

- **For the following steps, please prepare:**
- Quick Release cable - Printer Side (1x)
- Quick Release cable - Black PSU Side (1x)

## STEP 11 Installing the quick release cable

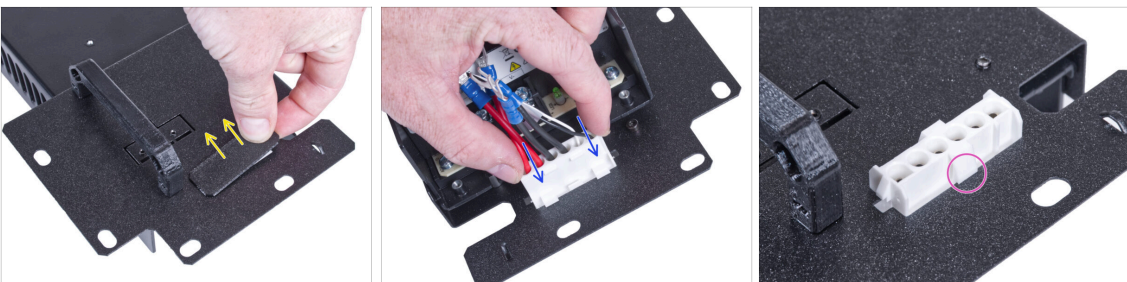

- Remove the plug from the PSU holder.
- Insert the Quick Release cable - Black PSU Side into the hole in the PSU holder.
- From the opposite side of the PSU holder check that the latches on the connector are engaged with the metal sheet.

## STEP 12 Connecting the PSU cables

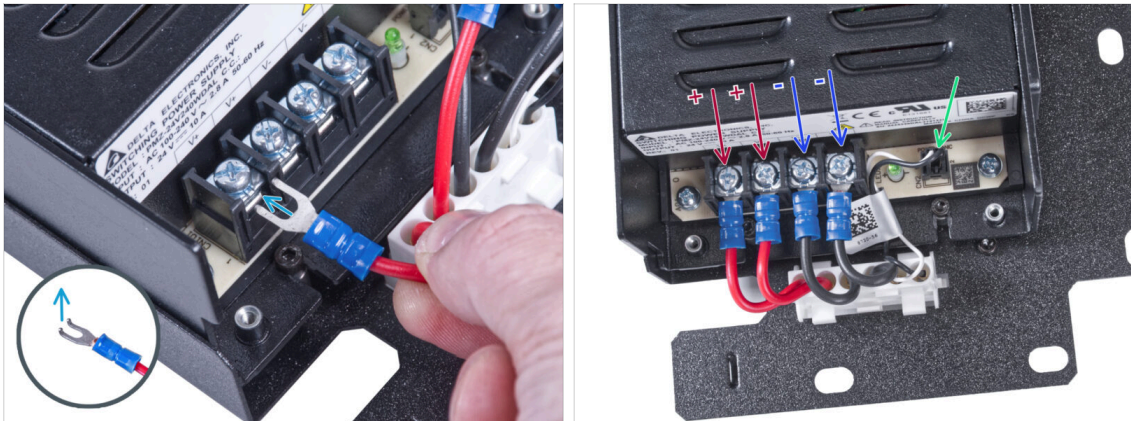

- Take the first **positive** (red) wire from the Quick Release cable - Black PSU Side connector and connect it to the first terminal from the left on the PSU. Bent part of the connector is facing up. Push it below the square washer, all the way in.
- **Use this method for all PSU cables and connect them in the following order:**
  - **POSITIVE** (red) wire
  - **POSITIVE** (red) wire
  - **NEGATIVE** (black) wire
  - **NEGATIVE** (black) wire
- ⚠ **Check the connection again!** The red wire is in the first slot and black in the third. Make sure that cables are properly tightened. Otherwise, there is a risk of damage to the printer!
- Connect the power panic cable to the PSU.

## STEP 13 Covering the PSU: parts preparation



- **For the following steps, please prepare:**
  - PSU-cover (1x) *you removed earlier*
  - M3x10 screw (2x) *you removed earlier*

## STEP 14 Covering the PSU

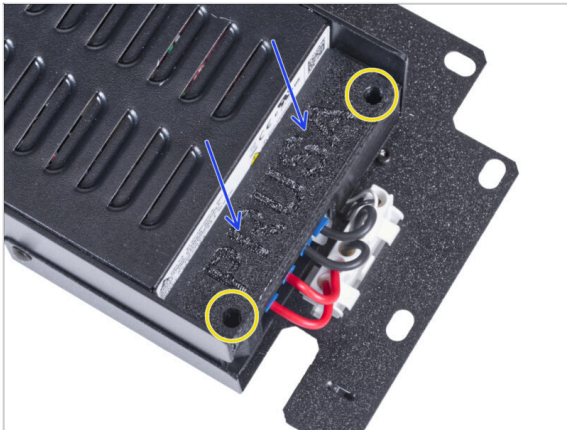

- Slide the cover on the cables from the top. Make sure the "PRUSA" logo is facing up.
- Secure the cover using two M3x10 screws. Note that the holes are quite deep.

## STEP 15 Connecting the power cables

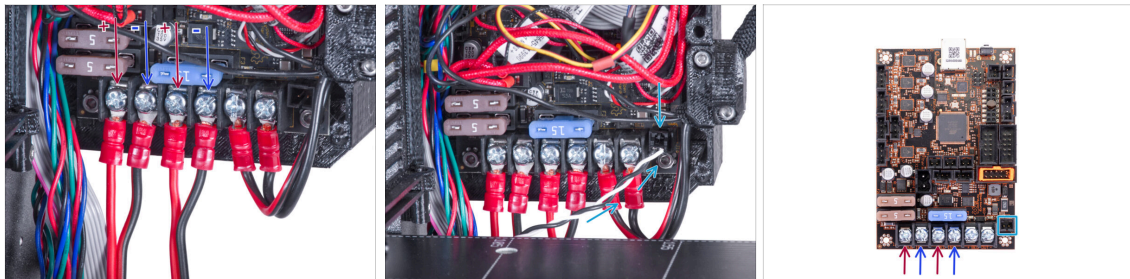

- Connect the quick release power cables to the Einsy board in the following order (from the left):
  - POSITIVE (red) wire
  - NEGATIVE (black, black/red) wire
  - POSITIVE (red) wire
  - NEGATIVE (black, black/red) wire
- Connect the power panic cable to the Einsy board.
- ⚠ Check the cable connection according to the last picture.

## STEP 16 Organizing the cables

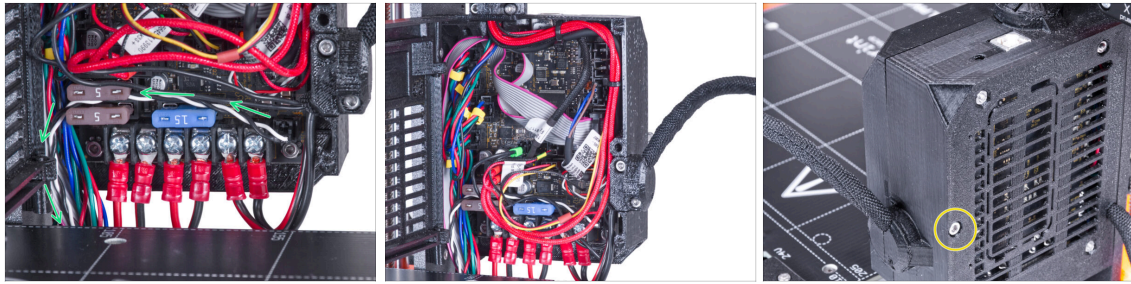

- ◆ Guide the power panic cable according to the picture.
- ◆ Arrange all cables as you can see in the picture.
- ◆ Close the electronics box and tighten the M3x40 screw.
- ⚠ **Be careful not to pinch cables!**

## STEP 17 Covering the quick release cable: parts preparation

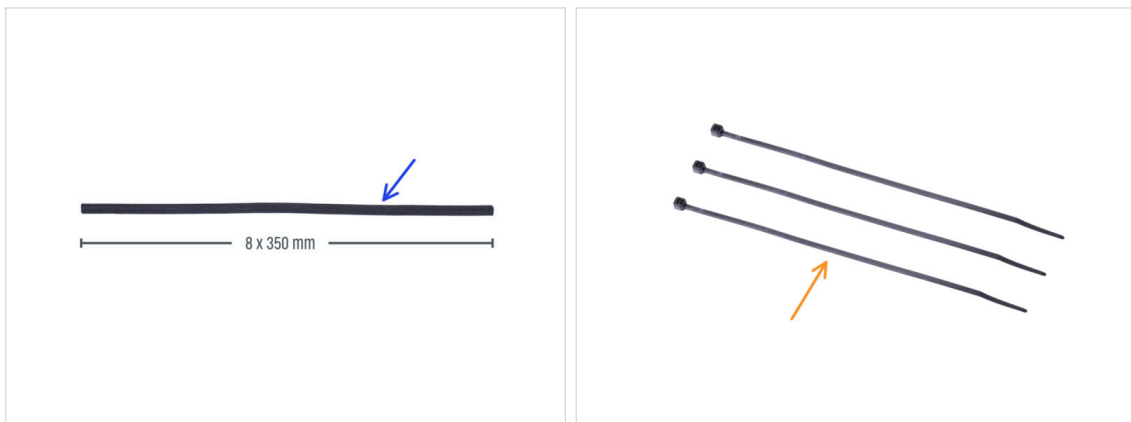

- ◆ **For the following steps, please prepare:**
- ◆ Textile sleeve 8 x 350 mm (1x) *you removed earlier*
- ◆ Zip tie (3x)



## STEP 18 Covering the quick release cable

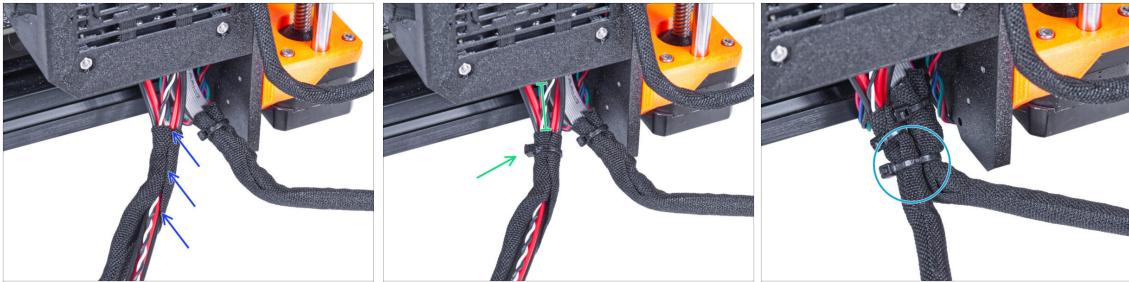

- From the electronics, wrap the quick release cable (including the black&white power panic cable) in the textile sleeve.
- Leave 2-5 cm from the electronics uncovered. Secure the end of the sleeve with the zip tie.
- Merge the LCD cable bundle and the PSU cable bundle and secure them together with the zip tie.

 **Do not over tighten the zip tie! It can damage the cables.**

## STEP 19 Covering the quick release cable

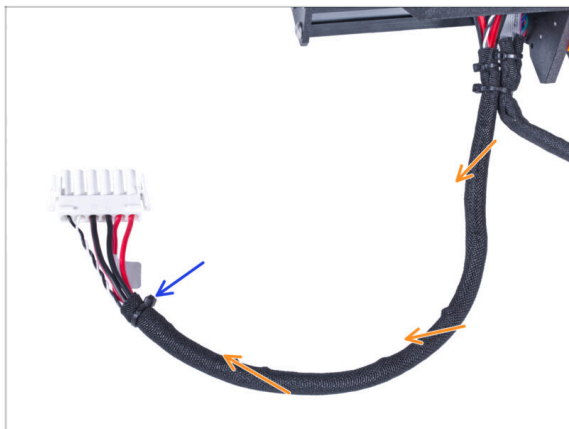

- Wrap the entire length of the bundle and slightly twist the sleeve, **not the cables**.
- Secure the end of the sleeve with the zip tie.

## STEP 20 Installing the PSU

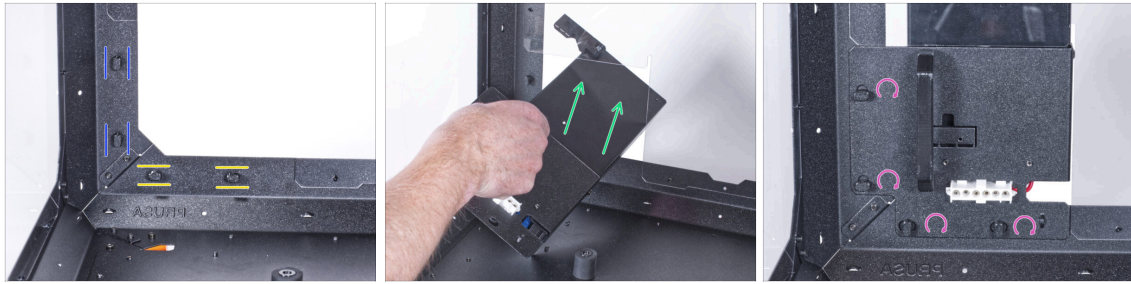

- ◆ Now, prepare the enclosure on the work surface.
- ◆ Ensure the PSU-locks are still turned at the same position:
  - **On the bottom frame**, turn the PSU-locks to the horizontal position.
  - **On the support**, turn the PSU-lock to the vertical position.
- ◆ Push the PSU through the opening in the back panel.
- ◆ Attach the PSU-holder on the all PSU-locks.
- ◆ Turn all PSU-lock 90° to lock the PSU assembly.

## STEP 21 Installing the printer

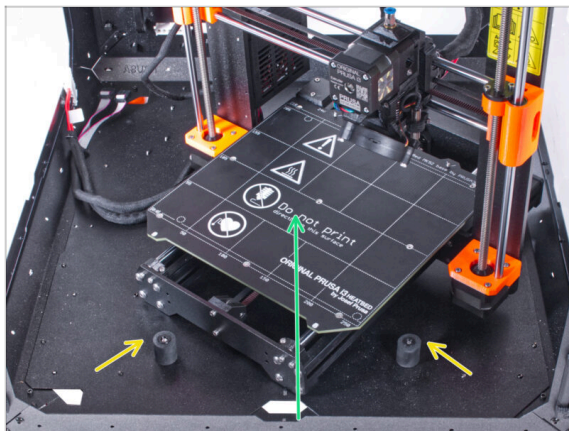

- ◆ To get the printer into the enclosure, insert its left side first.
  - ⚠ **Avoid scratching the side panels with the printer!**
- ◆ Place the printer at an angle (as shown in the picture) in the enclosure behind the anti-slip dampers.
  - ⓘ It's just a temporary position for the printer. We will adjust the correct position later.

## STEP 22 Connecting the quick release cable

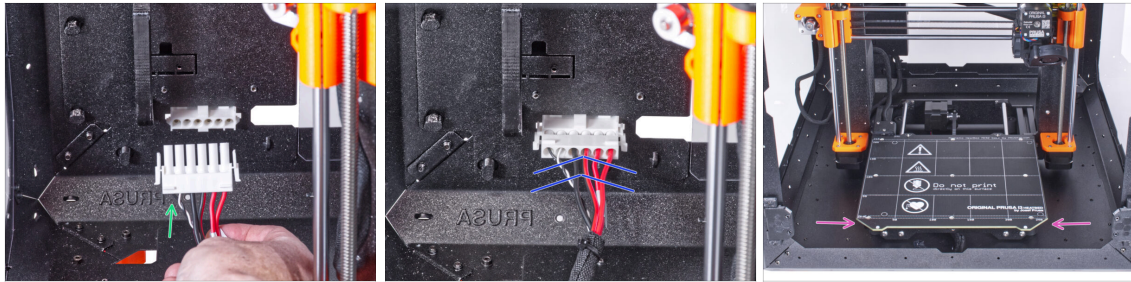

- ◆ Grasp the quick release guiding from the printer, with the power panic cable on the left.
- ◆ Plug the connector to the quick release cable in the PSU holder.
- ◆ Rearrange position of the printer like in the picture. Place it in the center of the enclosure and adjust the correct position.

## STEP 23 Mounting the LCD: parts preparation



- ◆ **For the following steps, please prepare:**
- ◆ LCD assembly (1x)
- ◆ Thumb screw M3x8 (2x)

## STEP 24 Mounting the LCD

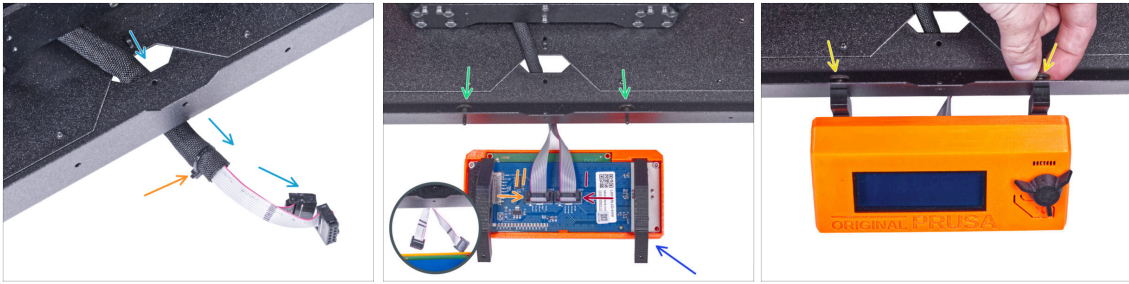

- Guide the LCD cable through the cutout in the bottom panel.
  - Secure the textile sleeve on the cable bundle with the zip tie. **Do not over tighten the zip tie**, it may cut the cables!
  - From the inside, push two thumb screws M3x8 through the bottom profile.
  - Place the LCD assembly close to the LCD cables, like in the picture. Mind the same orientation of the LCD as in the picture. See the LCD-supports for better understanding.
- ⚠ **Note that both cables are marked with stripes on one side. Correct connection order is important!**
- Connect the LCD cable marked with **TWO STRIPES** to the **left slot** (called EXP2) on the LCD controller.
  - Connect the LCD cable marked with **ONE STRIPE** to the **right slot** (called EXP1) on the LCD controller.
  - Slide the LCD assembly onto the two M3x8 screws in the frame and tighten them.

## STEP 25 Connecting the PTFE tube

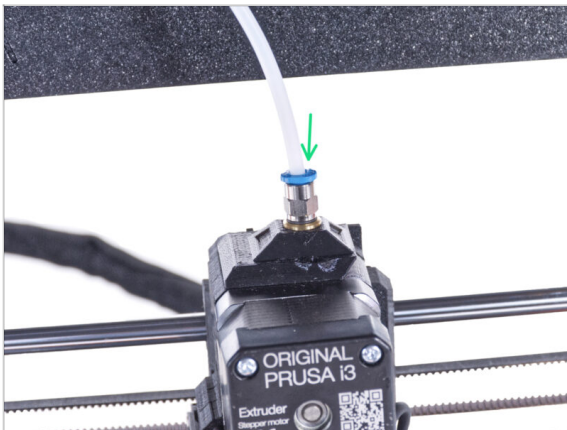

- Insert the free end of the PTFE tube to the Fitting QSM-M5 on the extruder. Insert it all the way down.

## STEP 26 Well done!

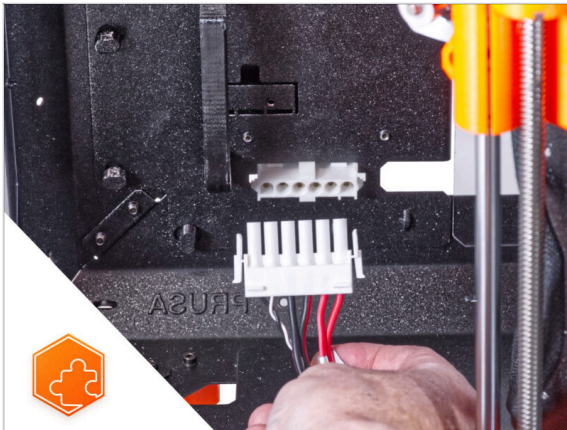

- ◆ **Good job!** You just successfully installed the quick release cable on the Original Prusa Enclosure.

## 10. Quick release PSU cable - MK4/3.9 Black PSU (add-on)

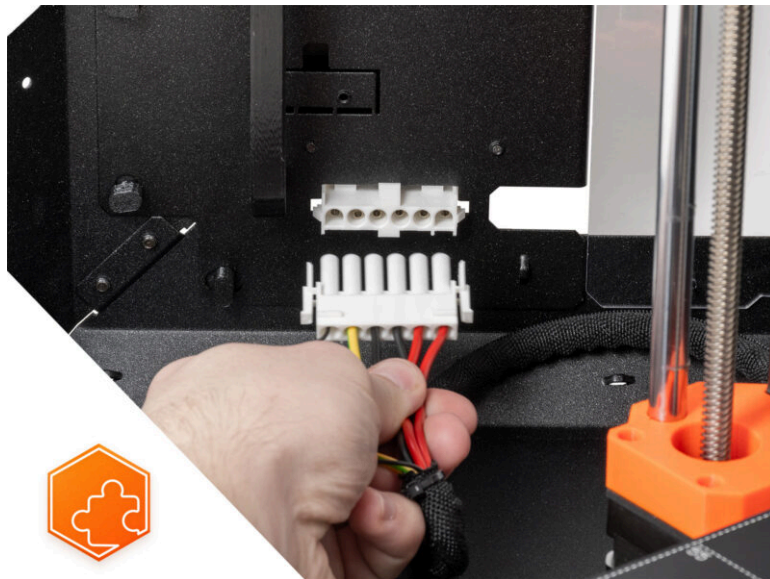

## STEP 1 Introduction

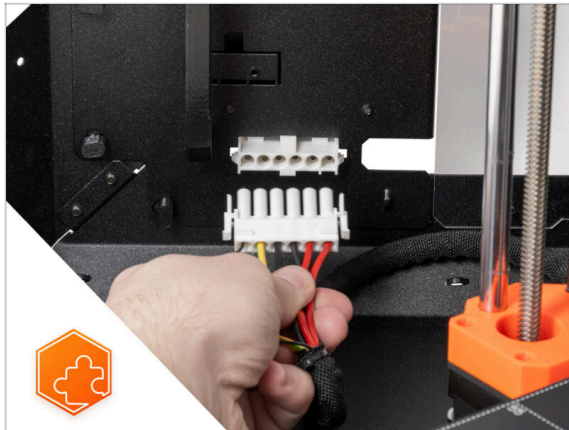

● This guide will take you through the installation of the **Quick release PSU cable** on the **Original Prusa Enclosure**.

⚠ **This add-on is compatible with Original Prusa MK4 and MK3.9.**

⚠ **This add-on is not compatible with the silver PSU.**

ⓘ Buy a compatible black PSU from our [E-shop](#).

## STEP 2 Tools necessary for this chapter

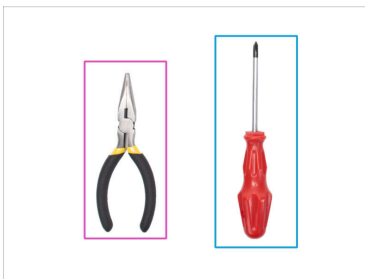
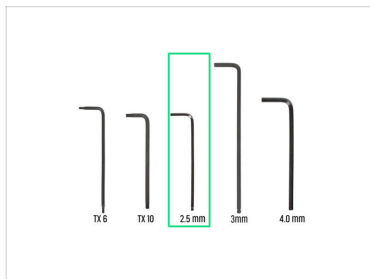

ⓘ Tools are not included in the add-on package.

● **For this chapter, please prepare:**

- 2.5 mm Allen key
- Needle-nose or cutting pliers
- Phillips screwdriver PH2
- Dust cloth (for heatbed cover)

### STEP 3 Removing the xLCD

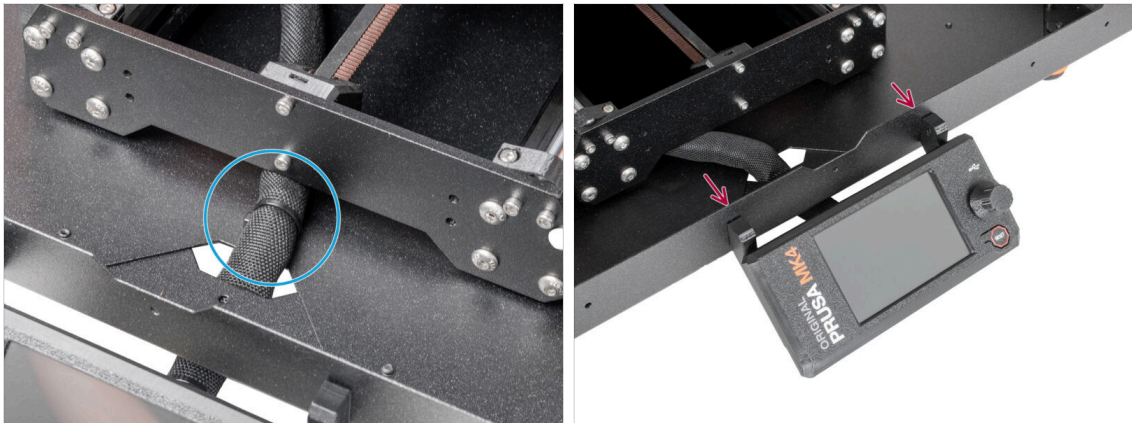

- ◆ Carefully cut the zip tie securing the xLCD cable bundle.
- ◆ Release two screws mounting the xLCD assembly.
- ⓘ Be gentle, the xLCD is still connected.

### STEP 4 Removing the xLCD cables

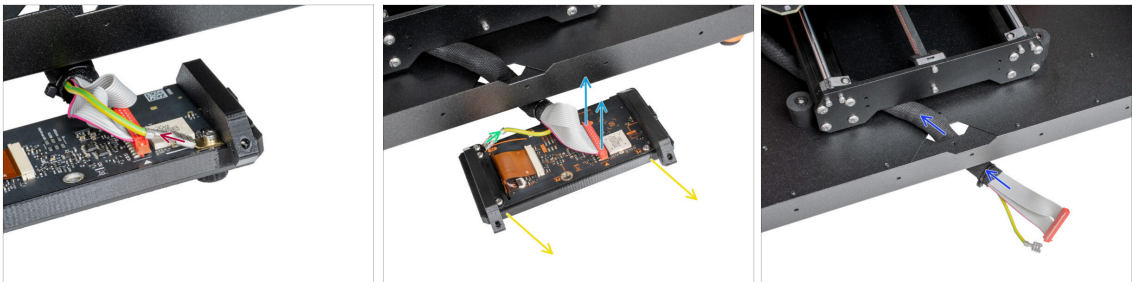

- ◆ xLCD PE cables are in two versions, unplug the PE cable:
  - ◆ **Version A:** unplug the PE cable from the upper PE Faston.
  - ◆ **Version B:** unplug the PE cable from the lower PE Faston.
- ◆ For both versions - gently unplug the xLCD cable.
- ◆ Take off the xLCD assembly and put it aside. We'll use it later.
- ◆ Push the xLCD cable bundle through the hole in the bottom panel into the enclosure.



## STEP 5 Removing the PTFE tube



- i** Starting from September 2024, you may receive a new black Fitting M5-4. The assembly and functionality remain identical to the blue one.
- ◆** Press down the blue collet on the Fitting QSM-M5.
- ◆** Pull out the PTFE tube from the fitting.

## STEP 6 Removing the printer

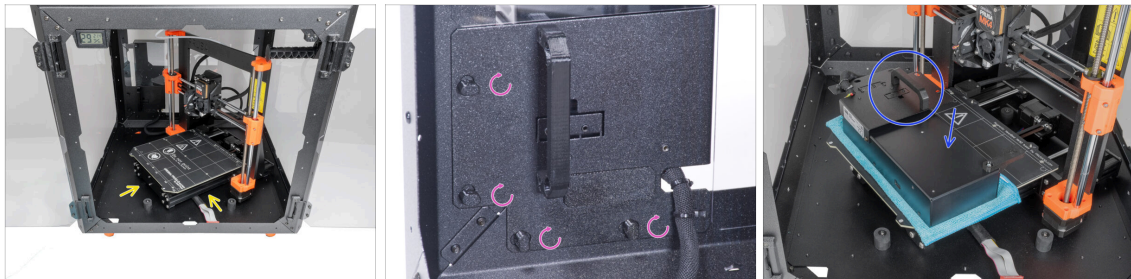

- ◆** Open the door of the enclosure.
- ◆** Place the printer at an angle (as shown in the picture) in the enclosure behind the anti-slip dampers.
- ◆** "Unlock" all PSU-locks and grasp the PSU assembly by its handle and remove it from the back panel.
- ◆** Place the PSU on the heatbed protected with the cloth. Turn it with the PSU-handle facing upwards.

## STEP 7 Removing the printer



- Carefully remove the printer from the enclosure.
- ⚠ **Avoid scratching the printer and enclosure.**
- Place the enclosure aside. We will need it later on.

## STEP 8 Disconnecting the PSU

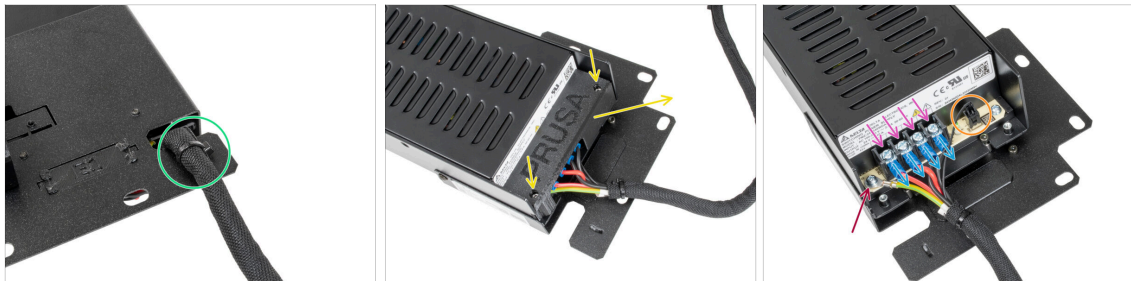

- On the PSU holder, cut off the zip tie securing the PSU cable.
- On the other side of the PSU assembly, loosen two screws mounting the PSU-cover and remove the cover from the PSU.
- Using a Phillips screwdriver, loosen all the screws on the PSU cables. **No need to remove the screws.**
- Remove all PSU cables from the terminals.
- Using a Phillips screwdriver, unscrew the screw holding the PE cable.
- Disconnect the power panic cable from the PSU.
- Place the disconnected PSU aside for now. We'll come back to that later.

## STEP 9 xLCD cable bundle sleeve

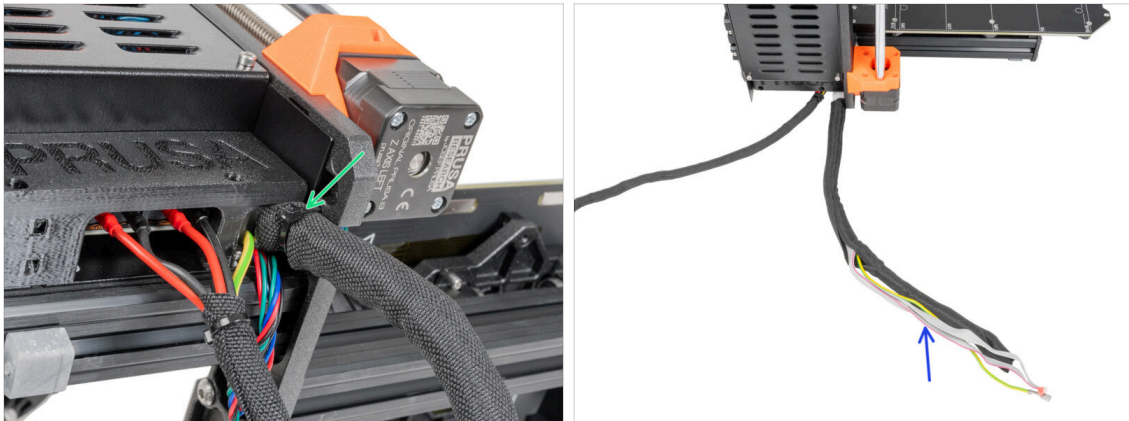

- Cut off the zip-tie holding the xLCD cable bundle.
- Take off the 450 mm sleeve from the xLCD cable bundle. Put the sleeve nearby, we'll use it later.

## STEP 10 xBuddy box cover



- Cut off the zip tie merging the power cables.
- From the front of the xBuddy box, loosen four M3x6 screws to release the xBuddy cover using a 2,5 mm Allen key. Take off the cover.
- Using a 2,5 mm Allen key, loosen two M3x10 screws holding el-box-cover. Take off the cover.

## STEP 11 Disconnecting the PSU cables

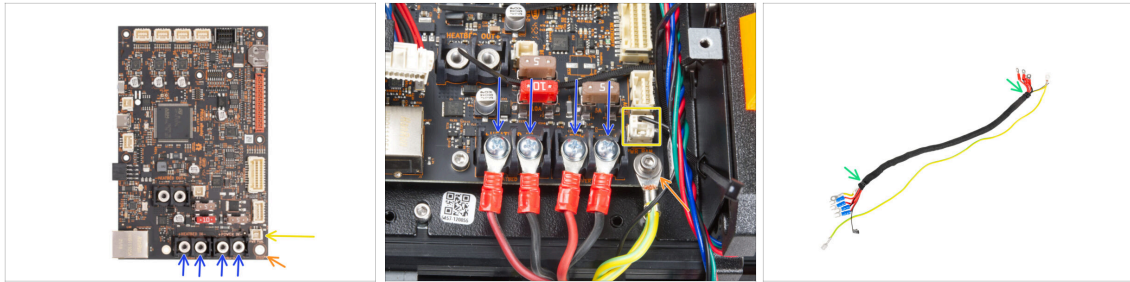

- ◆ Using the Phillips screwdriver, loosen the screws securing the PSU cables. And remove all the cables from the terminals. **Keep the screws for later!**
- ◆ Disconnect the Power panic cable from the electronics board.
- ◆ Using a 2,5 mm Allen key, unscrew the M3x6 screw and remove the PE cable with a washer. **Keep the washer and the screw for later!**
- ◆ Cut the zip ties on both ends of the textile sleeve and remove the sleeve from the cable bundle. **Keep the sleeve for later!**
- ⓘ You will no longer need this cable bundle. However, we recommend not discarding it. Keep it as a spare.
- ◆ Keep the electronics box open.

## STEP 12 Installing the quick release cable: parts preparation

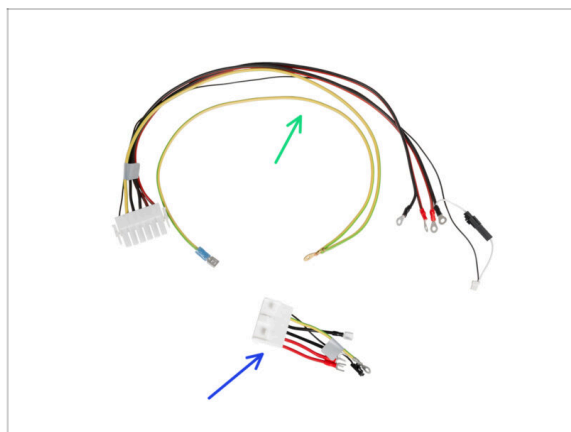

- ◆ **For the following steps, please prepare:**
- ◆ Quick Release cable - Printer Side (1x)
- ◆ Quick Release cable - Black PSU Side (1x)

### STEP 13 Quick release cable: power panic

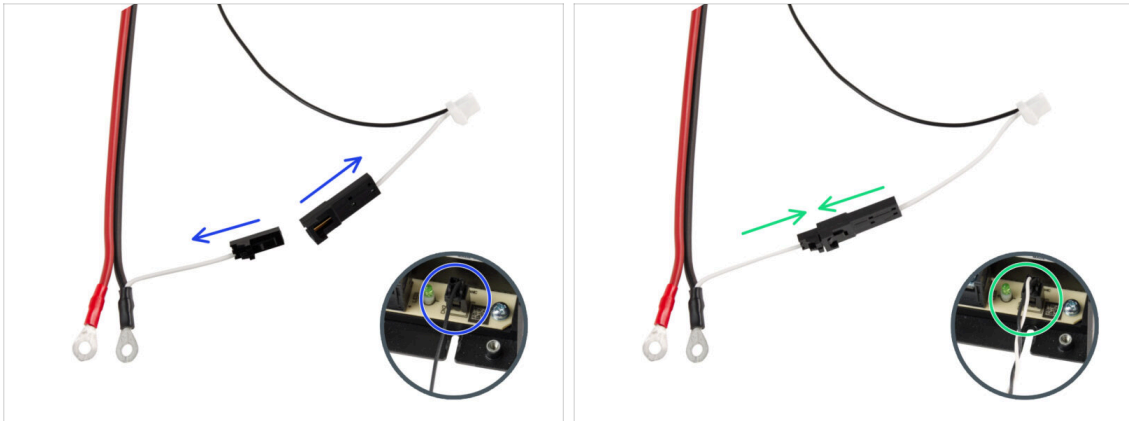

- Take the Quick release cable - Printer side.
- ⓘ **MK4 printers can have two versions of the Power panic cable** (you disconnected it from the PSU). The type of Power panic cable impacts how to prepare the Quick release cable.
- **Check what versions of the Power panic cable you have and follow the appropriate instructions:**
  - **Single cable (black):** the connecting plugs must remain disconnected.
  - **Dual-(black and white):** connect both plugs.
- Keep the Quick release cable aside. We will need it later on.

### STEP 14 Installing the quick release cable

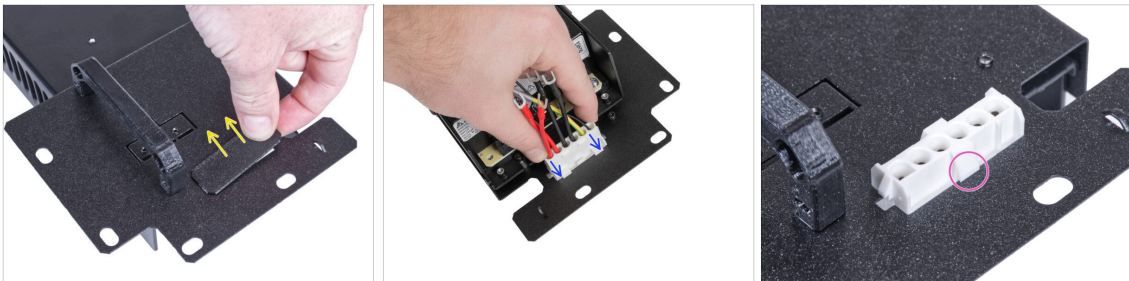

- Remove the plug from the PSU holder.
- Insert the Quick Release cable - Black PSU Side into the hole in the PSU holder.
- From the opposite side of the PSU holder check that the latches on the connector are engaged with the metal sheet.

## STEP 15 Connecting the PSU cables

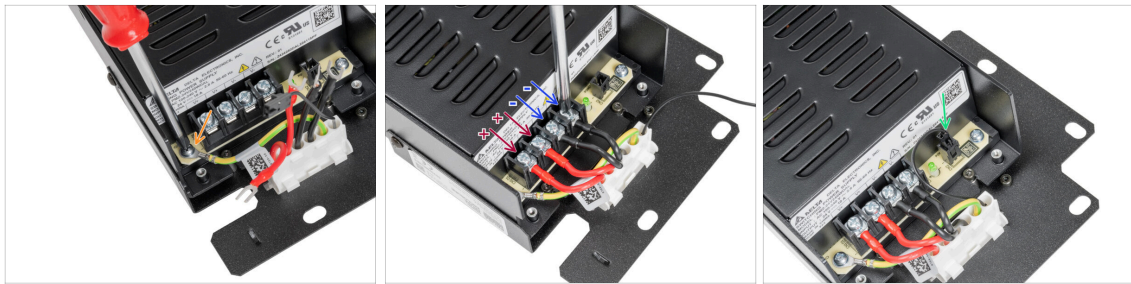

- 🟡 Loosen the screw on the PSU, and then attach the PE cable from the Quick release cable to the screw.
- ⬛ **Connect all PSU power cables. Use this method for all PSU cables and connect them in the following order:**
  - 🟠 **POSITIVE** (red) wire
  - 🟠 **POSITIVE** (red) wire
  - 🟢 **NEGATIVE** (black) wire
  - 🟢 **NEGATIVE** (black) wire
- ⚠️ **Check the connection again!** The red wire is in the first slot and black in the third. Make sure that cables are properly tightened. Otherwise, there is a risk of damage to the printer!
- 🟢 Connect the power panic cable to the PSU.

## STEP 16 Covering the PSU: parts preparation



- ⬛ **For the following steps, please prepare:**
- 🟢 PSU-cover (1x) *you removed earlier*
- 🟡 M3x10 screw (2x) *you removed earlier*

### STEP 17 Covering the PSU



- ◆ Slide the cover on the cables from the top. Make sure the "PRUSA" logo is facing up.
- ◆ Secure the cover using two M3x10 screws. Note that the holes are quite deep.

---

### STEP 18 Connecting the PSU cables: parts preparation

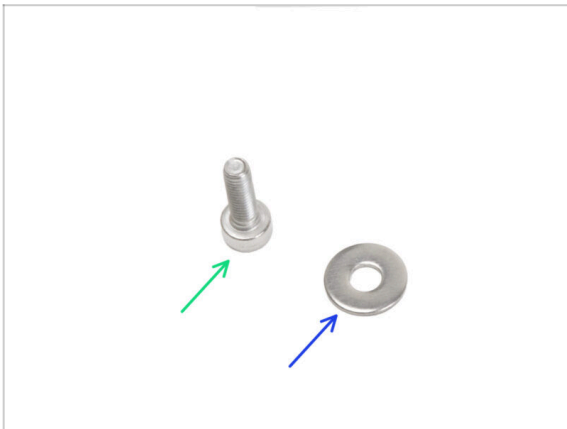

- ◆ **For the following steps, please prepare:**
- ◆ M3x6 screw (1x)
- ◆ M3w washer (1x)

## STEP 19 Connecting the PSU cables

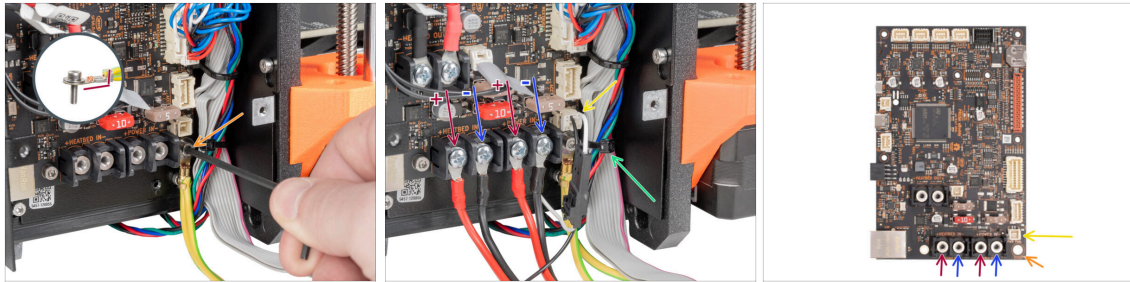

🛠 Using a 2,5 mm Allen key, secure the PE cable with the M3x6 screw with a washer.

⚠ **Note the correct orientation of the PE connector.**

🔌 **Connect the Quick Release cable - Printer Side to the xBuddy board in the following order (from the left):**

- 🔴 **POSITIVE** (red) wire
- 🔵 **NEGATIVE** (black, black) wire
- 🔴 **POSITIVE** (red) wire
- 🔵 **NEGATIVE** (black, black) wire

🟡 Connect the power panic cable to the xBuddy board.

🟢 Cut off the zip-tie holding the xLCD cable.

⚠ **Check the cable connection according to the last picture.**

## STEP 20 Covering the xBuddy box: parts preparation



🔌 **For the following steps, please prepare:**

- 🟢 xBuddybox-cover (1x)
- 🟡 M3x6 screw (4x)
- 🔵 EI-box-cover (1x)
- 🟠 M3x10 screw (2x)



## STEP 21 Covering the xBuddy box: bottom cover

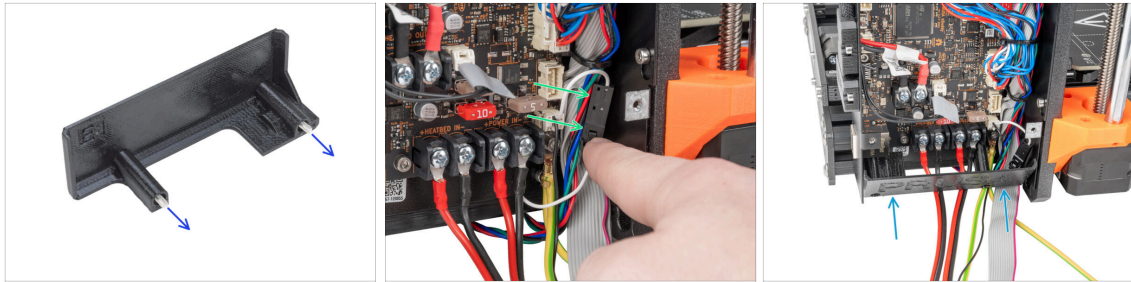

**⚠ Be careful, don't pinch any cable!**

- ➡ Push two M3x10 screws through the el-box-cover.
- ➡ Put the power panic connector on the right side of the xBuddy box.
- ➡ Gently insert the el-box-cover in its position as described.

## STEP 22 Covering the xBuddy box: bottom cover tightening

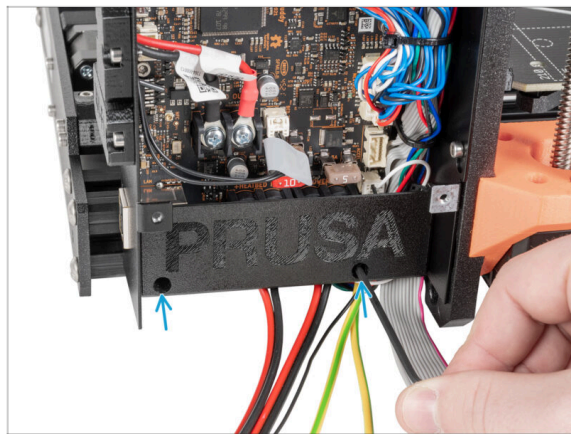

- ➡ Using a 2,5 mm Allen key, tighten two M3x10 screws.

## STEP 23 xBuddy box cover

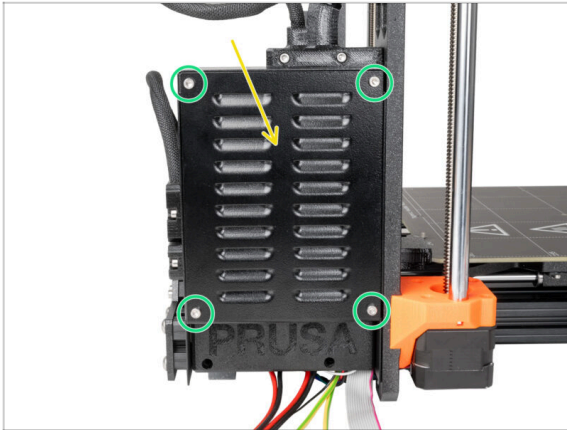

**⚠ Be careful not to pinch cables!**

- 🟡 Close the xBuddy box.
- 🟢 Insert four M3x6 screws and tighten them using a 2,5 mm Allen key.

## STEP 24 Covering the quick release cable: parts preparation



- **For the following steps, please prepare:**
- 🟡 Textile sleeve 8 x 350 mm (1x) *you removed earlier*
- 🟢 Zip tie (2x)

## STEP 25 Covering the quick release cable

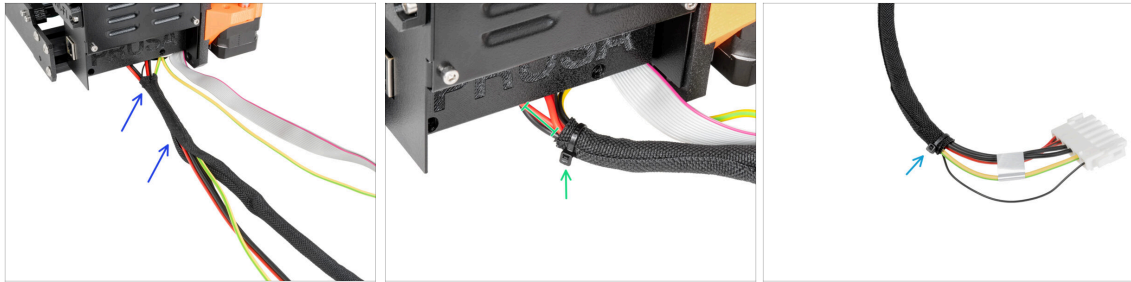

- From the electronics, wrap the quick-release cable (including the black power panic cable) in the textile sleeve.
- ⚠ Do not over-tighten the zip tie! It can damage the cables.
- Leave 2-5 cm from the electronics uncovered. Secure the end of the sleeve with the zip tie.
- Secure the second end with the zip-tie.

## STEP 26 Covering the xLCD cables: parts preparation



- For the following steps, please prepare:
  - Textile sleeve 13 x 400 mm (1x)
  - Zip tie (1x)

## STEP 27 Covering the xLCD cable bundle

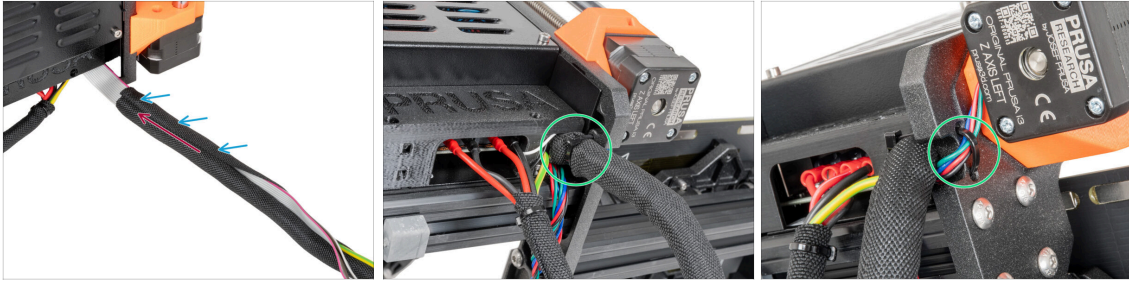

- From the electronics, wrap the xLCD and PE cables in the textile sleeve.
  - Push the textile sleeve near to the electronics box.
  - Wrap the entire length of the xLCD cable bundle.
  - Using the zip tie, create a loop through the circle holes in the frame around the motor cables and xLCD cable bundle.
- i** Do not forget to include the Z-axis left motor cable on the front side of the frame! See the detail.

## STEP 28 Installing the PSU

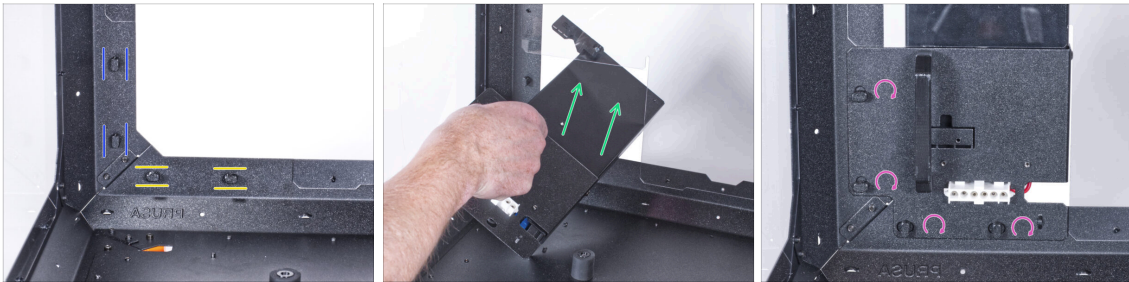

- Now, prepare the enclosure on the work surface.
- Ensure the PSU-locks are still turned at the same position:
  - **On the bottom frame**, turn the PSU-locks to the horizontal position.
  - **On the support**, turn the PSU-lock to the vertical position.
- Push the PSU through the opening in the back panel.
- Attach the PSU-holder on the all PSU-locks.
- Turn all PSU-lock 90° to lock the PSU assembly.

## STEP 29 Installing the printer

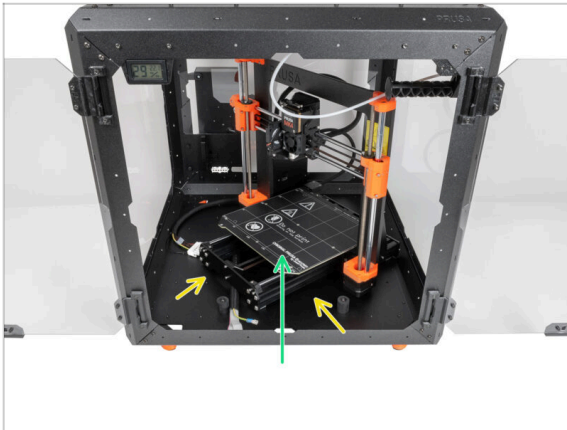

- To get the printer into the enclosure, insert its left side first.
- ⚠ **Avoid scratching the side panels with the printer!**
- Place the printer at an angle (as shown in the picture) in the enclosure behind the anti-slip dampers.
- ⓘ It's just a temporary position for the printer. We will adjust the correct position later.

## STEP 30 Connecting the quick release cable

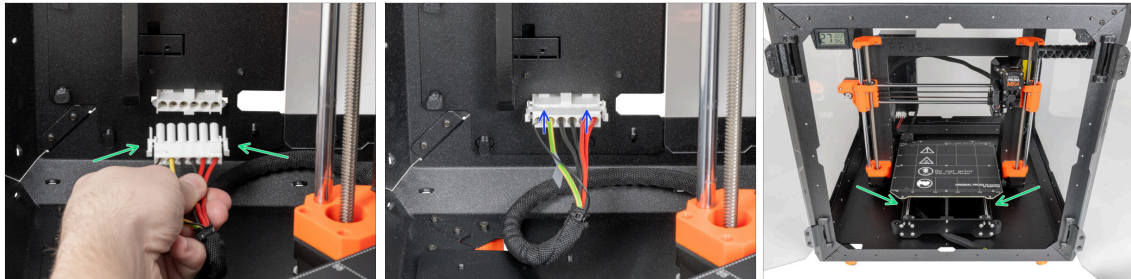

- Grasp the quick release guiding from the printer, with the power panic cable on the left.
- Plug the connector to the quick release cable in the PSU holder.
- ⓘ The quick-release connector can be plugged in only in one orientation.
- Rearrange position of the printer like in the picture. Place it in the center of the enclosure and adjust the correct position.

## STEP 31 Mounting the xLCD: parts preparation



### For the following steps, please prepare:

- xLCD assembly (1x)
- M3x8 thumb screw (2x)
- Zip tie (2x)

## STEP 32 Version A: Mounting the xLCD

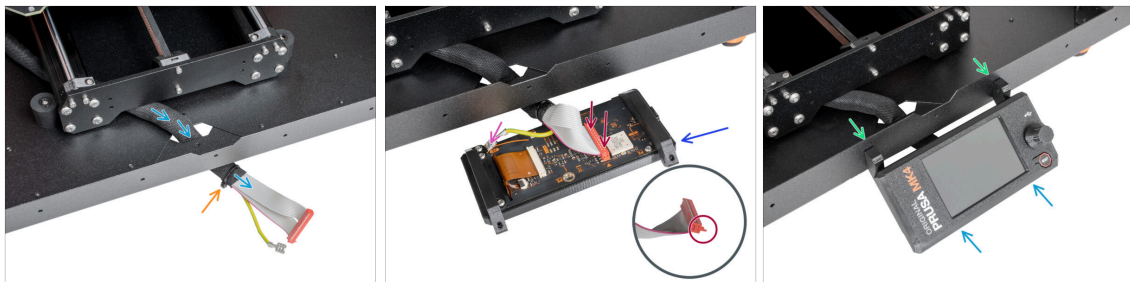

- Guide the xLCD cable through the cutout in the bottom panel.
- Secure the textile sleeve on the cable bundle with the zip tie. **Do not over tighten the zip tie**, it may cut the cables!
- Place the xLCD assembly close to the xLCD cables, like in the picture. Mind the same orientation of the xLCD as in the picture. See the xLCD-supports for better understanding.
  - Connect the xLCD cable to the xLCD board. Note the safety latch on the xLCD cable connector. It must be plugged into the side of the xLCD slot marked with the orange triangle on the board.
  - Take the end of the PE cable with square connector. Slide the connector onto the PE Faston all the way down.
- From the inside, push two M3x8 screws through the bottom profile.
- Slide the xLCD assembly onto the two M3x8 screws in the frame and tighten them.

## STEP 33 Version B: Mounting the xLCD

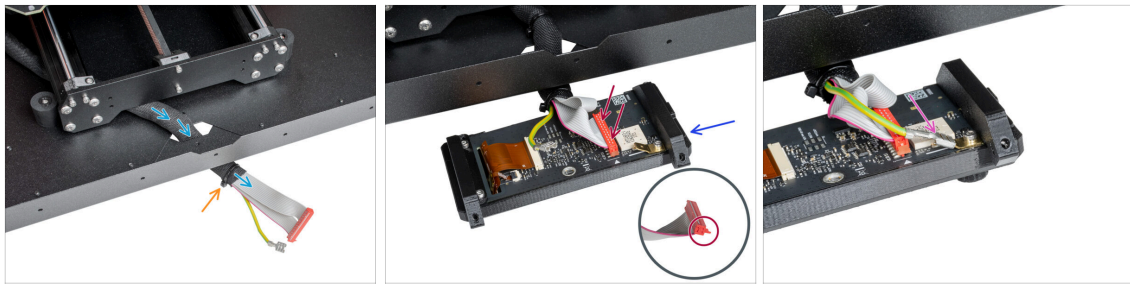

- ◆ Guide the xLCD cable through the cutout in the bottom panel.
- ◆ Secure the textile sleeve on the cable bundle with the zip tie. **Do not over tighten the zip tie**, it may cut the cables!
- ◆ Place the xLCD assembly close to the xLCD cables, like in the picture. Mind the same orientation of the xLCD as in the picture. See the xLCD-supports for better understanding.
  - ◆ Connect the xLCD cable to the xLCD board. Note the safety latch on the xLCD cable connector. It must be plugged into the side of the xLCD slot marked with the orange triangle on the board.
  - ◆ Take the end of the PE cable with square connector. Slide the connector onto the PE Faston all the way down.

## STEP 34 Mounting the xLCD



- ◆ Push two thumb screws through the bottom plate to the xLCD. Secure it by manually tightening the screws.
- ◆ Slide the xLCD assembly onto the two M3x8 screws in the frame and tighten them.

### STEP 35 Securing the xLCD cable

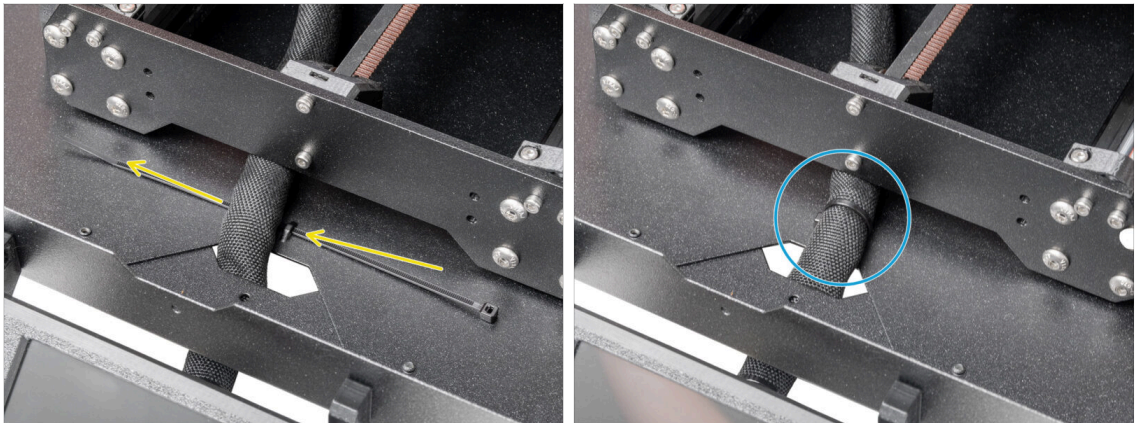

- Guide the zip tie through the perforation in the bottom panel and under the xLCD cable bundle.
- Tighten the zip tie to secure the xLCD cable bundle. **Do not over tighten the zip tie, it may cut the cables!**

### STEP 36 Connecting the PTFE tube



- ⓘ Starting from September 2024, you may receive a new black Fitting M5-4. The assembly and functionality remain identical to the blue one.
- Insert the free end of the PTFE tube to the Fitting QSM-M5 on the extruder. Insert it all the way down.



## STEP 37 Well done!

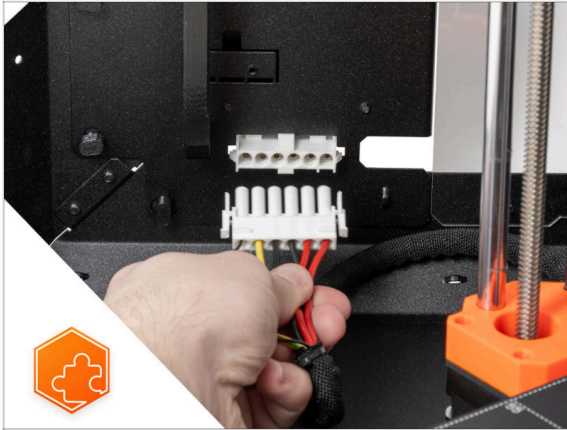

- ◆ **Good job!** You just successfully installed the quick release cable on the Original Prusa Enclosure.

## 11. White LED strip (add-on)

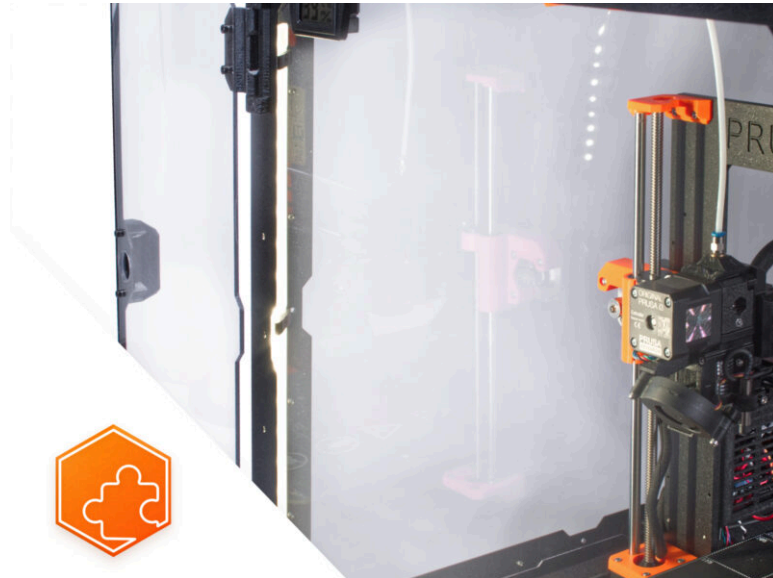

## STEP 1 Introduction

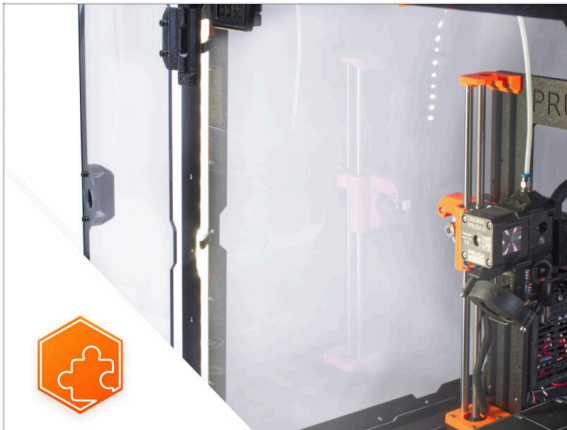

- ◆ This guide will take you through the installation of the **White LED strip** on the **Original Prusa Enclosure**.
- ⓘ The supplied fasteners include extra spare parts.

## STEP 2 Different external PSU

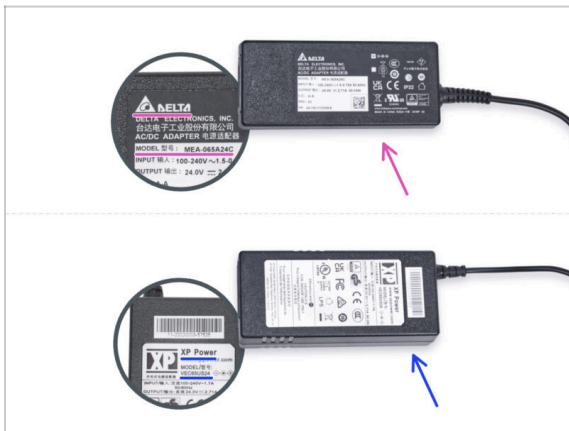

- ⓘ The White LED strip add-on has been shipped with two types of the external PSU, each from a different manufacturer. The functionality of both versions is the same, but the installation procedure is slightly different.
- ◆ On the label of the external PSU, check what model do you have and follow the appropriate instructions:
  - ◆ **External PSU Delta model MEA-065A24C:** go to [Introduction - External PSU Delta](#)
  - ◆ **External PSU XP Power model VEC65US24:** go to [Introduction - External PSU XP Power](#)

### STEP 3 Introduction - External PSU Delta



- ◆ The following instructions are intended for installing the **White LED strip** with the **External PSU Delta model MEA-065A24C** on the **Original Prusa Enclosure**.
- ◆ **Before you start installing the add-on, PRINT OUT ALL NECESSARY PLASTIC PARTS!** The External-PSU-bracket-DELTA and the Basic-board-cover are available for download at [Printables.com](https://printables.com)
- ⓘ Note: the External-PSU-bracket-DELTA is intended for mounting the external PSU to the enclosure. However, it is not necessarily required.

### STEP 4 Tools necessary for this chapter



- ⓘ Tools are not included in the add-on package.
- ◆ **For this chapter, please prepare:**
  - ◆ 2.5mm Allen key
  - ◆ Needle-nose pliers (*to trim the zip ties*)
  - ◆ Piece of cloth or fabric at least 15 x 15 cm

## STEP 5 Mounting the external PSU (optional): parts preparation



**i** Note: the External-PSU-bracket-DELTA is intended for mounting the external PSU to the enclosure. However, it is not necessarily required. If you do not want to install the External PSU bracket, go to [Preparing the printer](#).

**■** For the following steps, please prepare:

- External PSU Delta (1x)
- M3x8 screw (1x)
- M3nS nut (1x)
- External-PSU-bracket-DELTA (1x)

## STEP 6 Mounting the external PSU (optional)



- Insert the M3nS nut into the External PSU bracket. Using the Allen key, push the nut all the way into the printed part and align the nut with the hole in the part.

## STEP 7 Assembling the external PSU bracket (optional)



- ✦ Insert the external PSU into the External PSU bracket and push it all the way in. Mind the correct orientation of the PSU.
- ✦ Guide the external PSU cable like in the picture and attach the cable ferrite into the clip on the printed part.



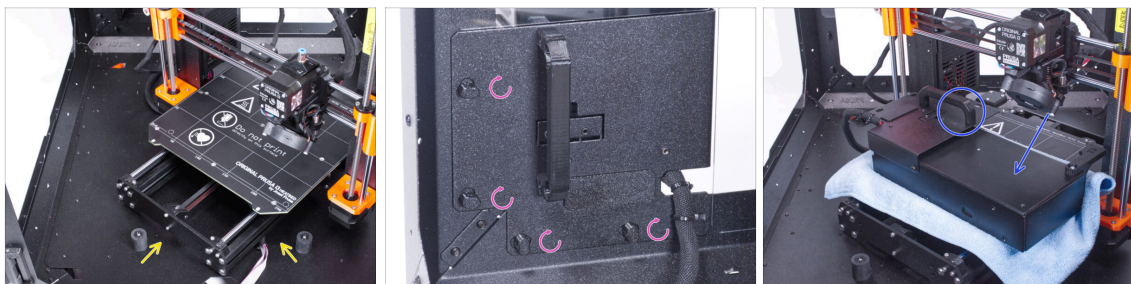



## STEP 8 Preparing the printer

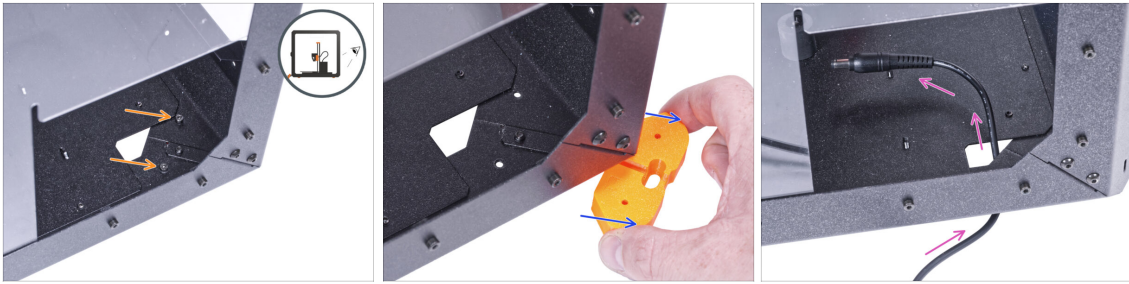

- ⬛ Open the door of the enclosure.
- ✦ Place the printer at an angle (as shown in the picture) in the enclosure behind the anti-slip dampers.
- ✦ "Unlock" all PSU-locks and grasp the PSU assembly by its handle and remove it from the back panel.
- ⬢ Place the PSU on the heatbed protected with the cloth. Turn it with the PSU-handle facing upwards.



## STEP 9 Guiding the external PSU cable

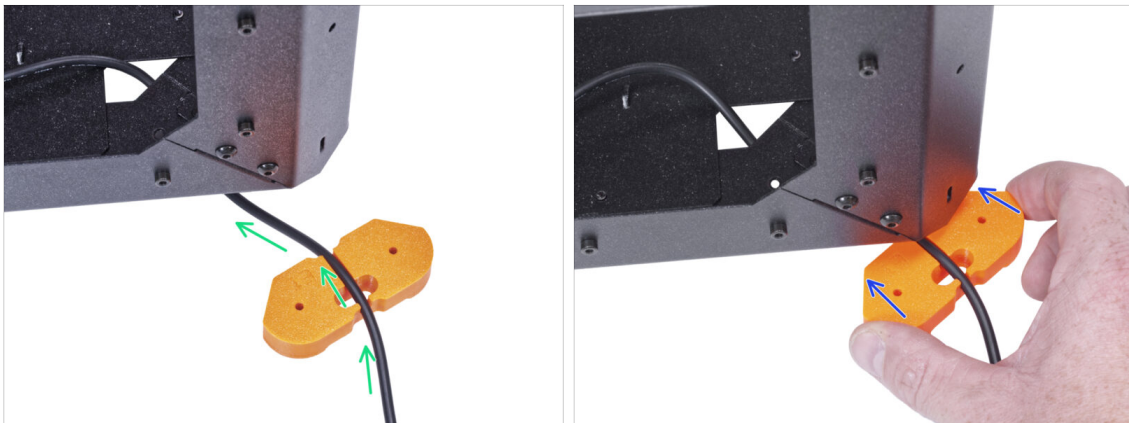

-  **Be careful not to pinch your fingers when handling under the enclosure.**
-  If handling the enclosure is difficult due to its weight, you can remove the printer out.
-  Turn the enclosure with the rear side facing you.
-  Through the rectangular hole in the back panel, release two screws mounting the foot to the bottom panel.
-  Remove the foot from the bottom of the enclosure. **Do not discard the part, you will need it again in a while.**
-  Guide the PSU cable through the hole in the bottom panel into the enclosure.

## STEP 10 Guiding the external PSU cable



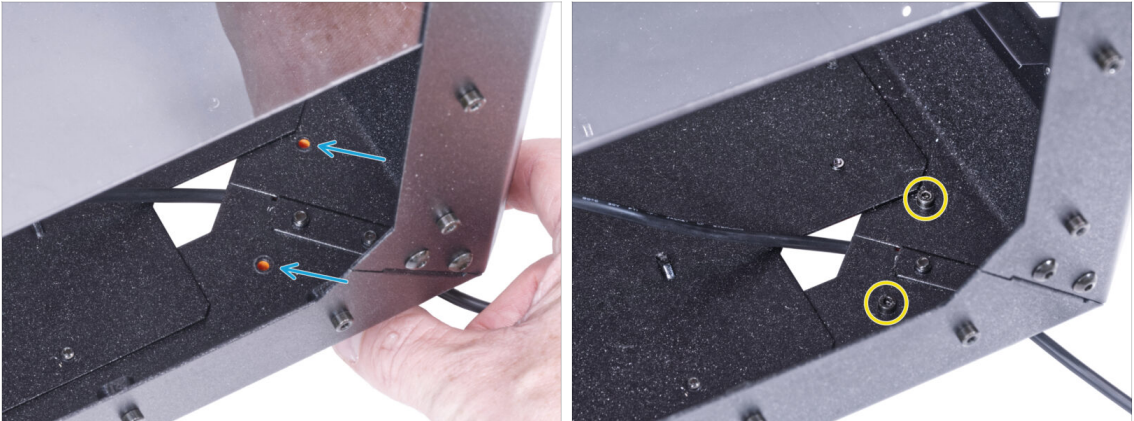

-  **Be careful not to pinch your fingers when handling under the enclosure.**
-  Guide the external PSU cable through the channel in the feet bracket. **See the orientation of the feet bracket.**
-  Slide the feet bracket with the cable under the corner of the enclosure.

## STEP 11 Guiding the external PSU cable







 **Be careful not to pinch your fingers when handling under the enclosure.**

-  Align the holes in the foot bracket with the holes in the bottom profiles.
-  Secure the foot bracket with two M3x12 screws.

## STEP 12 Mounting the external PSU (optional)



-  The following instructions are for mounting the external PSU to the enclosure. If you do not want to mount the external PSU to the enclosure, go to [Installing the PSU](#).
-  From the inside, push the M3x8 screw through the hole in the bottom profile next to the PRUSA logo.
-  Attach the external PSU assembly on profile. And align it against the screw.
-  Tighten the M3x8 screw from inside to mount the external PSU.



## STEP 13 Installing the PSU

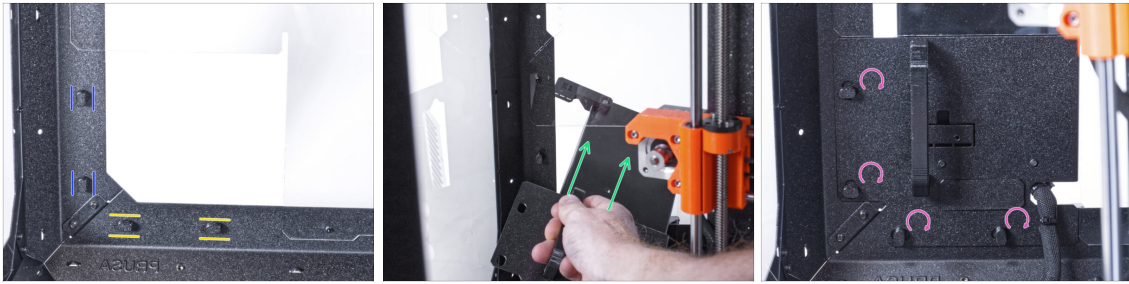

- Ensure the PSU-locks are still turned at the same position:
  - **On the bottom frame**, turn the PSU-locks to the horizontal position.
  - **On the support**, turn the PSU-lock to the vertical position.
- Push the PSU through the opening in the back panel.
- Attach the PSU-holder on the all PSU-locks.
- Turn all PSU-lock 90° to lock the PSU assembly.

## STEP 14 Guiding the external PSU cable

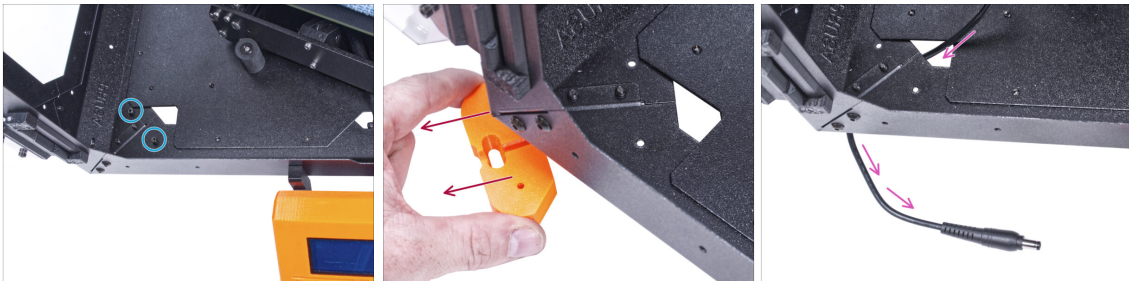

- ⚠ **Be careful not to pinch your fingers when handling under the enclosure.**
- Release two screws mounting the front left foot.
- Remove the foot from the enclosure. **Do not discard the part**, you will need it again in a while.
- Guide the external PSU cable through the hole in the bottom panel out of the enclosure.

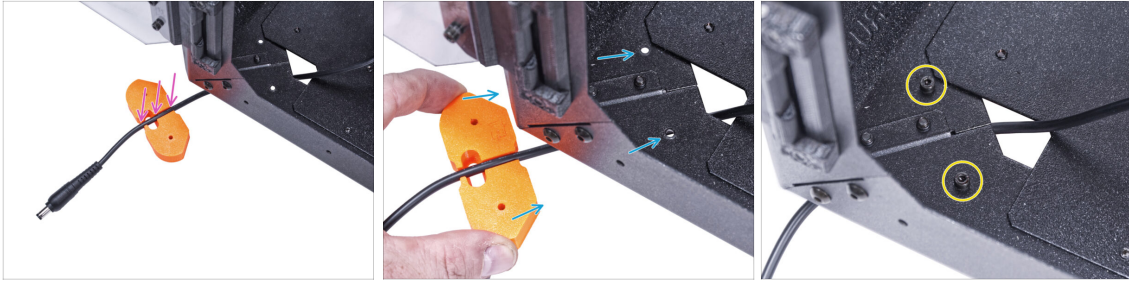
**STEP 15** Guiding the external PSU cable

**⚠ Be careful not to pinch your fingers when handling under the enclosure.**

- ◆ Guide the external PSU cable through the channel in the feet bracket.
- ◆ Slide the feet bracket with the cable under the corner of the enclosure and align the holes in the part with the holes in the bottom profile.
- ◆ Secure the feet bracket with two M3x12 screws.
- ◆ Leave the external PSU cable free for now. We will connect it later on.

**STEP 16** Assembling the LED strip: parts preparation

**i** From November 2024, you may receive a new LED Stick Board, which can be supplemented with an additional LED strip.

**◆ For the following steps, please prepare:**

- ◆ LED diffuser (1x)
- ◆ LED Stick Board (1x)
- ◆ LED Stick Bracket (3x)
- ◆ M3x18 screw (3x)
- ◆ M3n nut (3x)

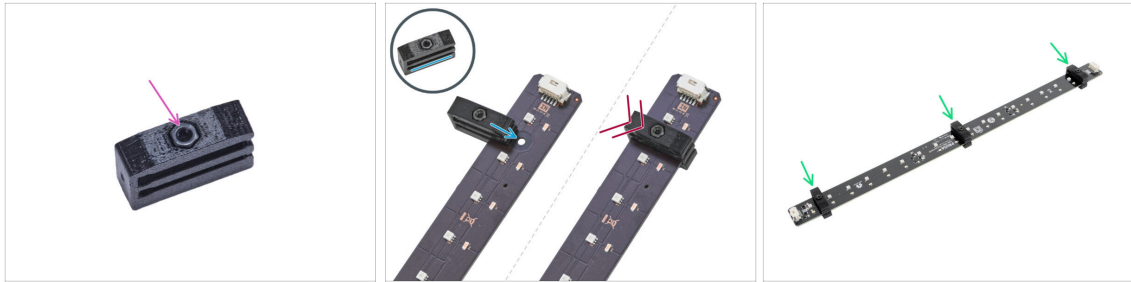
**STEP 17** Assembling the LED strip

- ◆ Insert the M3n nut into each LED Stick Bracket.
  - ⚠ **The nut must be completely embedded in the printed part and flush with the surface of the part. Insufficient embedment of the nut can cause problems when mounting in the enclosure.**
- ◆ Slide the lower slot of the LED Stick Bracket on the LED Stick Board and align the bracket against the first hole in the LED Stick Board closest to the (white) LED stick connector.
  - ⚠ **Avoid sliding the bracket over chips and diodes! It can be fatally damaged.**
- ◆ Push the LED Stick Bracket all the way on the LED Stick Board.
- ◆ Use this procedure for all three LED Stick Brackets.

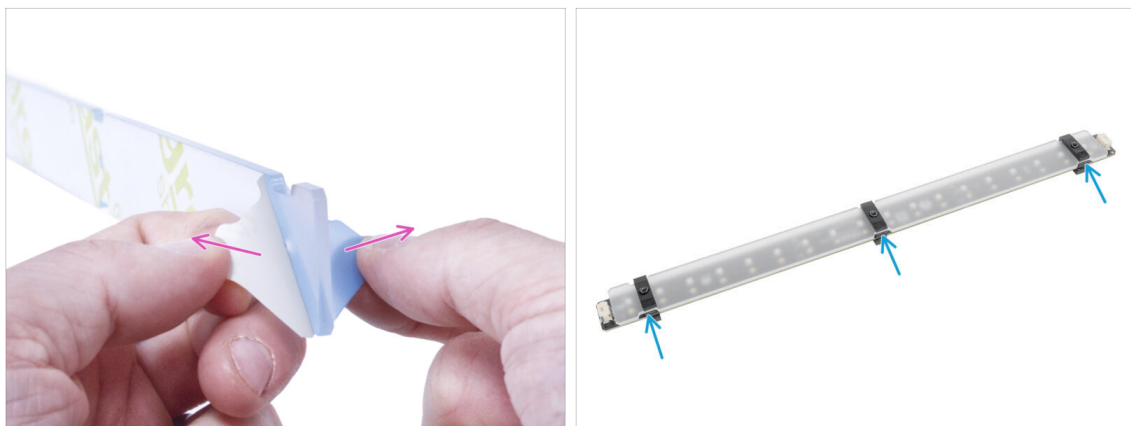
**STEP 18** Assembling the LED strip

- ◆ Remove the protection films from both sides of the LED diffuser.
- ◆ Push the LED diffuser into the LED Stick Brackets. Use the upper slot.
  - ⓘ The orientation of the LED diffuser doesn't matter. The part is symmetrical.

## STEP 19 Mounting the LED strip



- From the outside, insert three M3x18 screws into the holes in the front left support profile.
- From the inside of the enclosure, attach the LED strip assembly on the M3x18 screws.
- Tighten all three M3x18 screws to secure the LED strip assembly.

## STEP 20 Connecting the LED strip: parts preparation



- **For the following steps, please prepare:**
- LED cable (1x)
  - Zip tie (4x)

## STEP 21 Guiding the cables



- ◆ Push three zip ties through the perforation in the bottom left profile.
- ◆ Make a loop with the PSU cable according to the picture.
- ◆ Secure the external cable with the first zip tie on the bottom profile.
- ◆ Guide the cable along the bottom profile over the zip ties and tighten the two remaining zip ties.

⚠ **Do not overtighten the zip ties! You can damage the cable.**

## STEP 22 Connecting the LED cable



- ◆ Connect the LED cable to the connector on the bottom of the LED strip.
- ◆ Guide the LED cable through the hole in the bottom panel out of the enclosure.
- ◆ Guide the zip tie through the perforation in the bottom left profile and tight together the LED cable and the external PSU cable using the zip tie.

⚠ **Do not overtighten the zip ties, you can damage the cable.**

- ◆ Rearrange position of the printer like in the picture. Place it in the center of the enclosure and adjust the correct position.

## STEP 23 Installing the basic board: parts preparation



● For the following steps, please prepare:

- Basic Board Cover (1x)
- Basic board (1x)
- M3x12 screw (2x)
- M3w serrated lock washer (2x)
- M3nS nut (2x)

## STEP 24 Installing the basic board



- Mount the M3nS nut on the M3x12 screw. Attach it in a few threads on the tip of the screw.
- Push the screw with the nut all the way into the same shape hole inside the Basic Board Cover.
- Remove the screw from the nut.

## STEP 25 Installing the basic board



- ◆ Use the same procedure for both slots in the Basic Board Cover.

## STEP 26 Connecting the LED cable

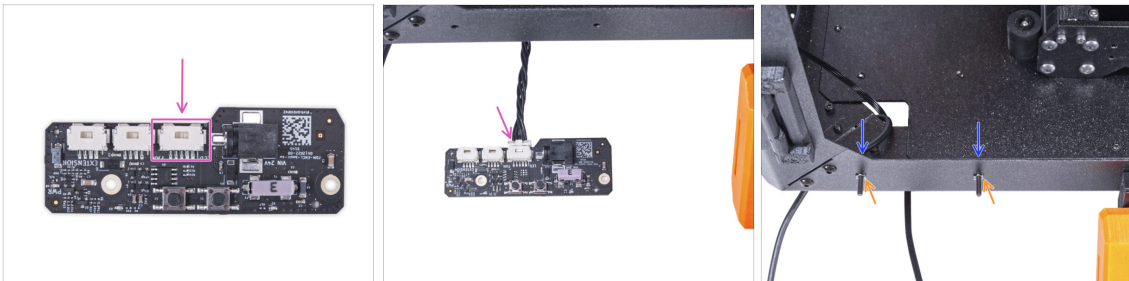

- ◆ Connect the LED cable to connector on the basic board.
- ◆ From inside the enclosure, insert two M3x12 screw through the front profile.
- ◆ Attach two M3w serrated lock washer on the screws.

## STEP 27 Mounting the basic board

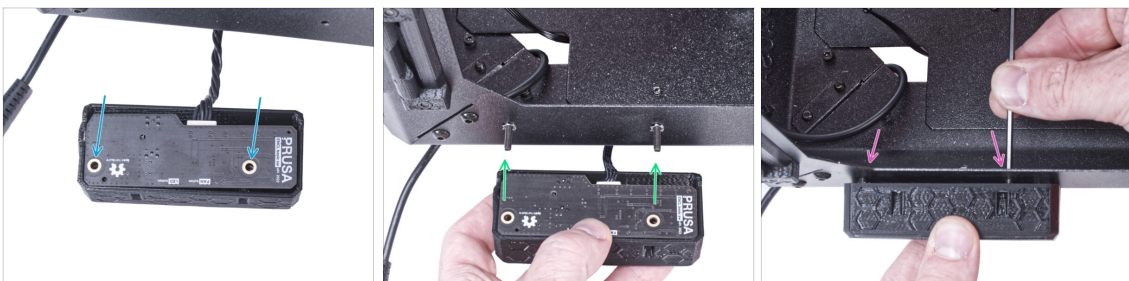

- ◆ Insert the basic board into the Basic Board Cover and align the holes on both parts.
- ◆ Take the basic board assembly and align the holes with the screws in the profile.
- ◆ Attach the basic board assembly to the screws and tighten the screws from the inside.

## STEP 28 Connecting the external PSU

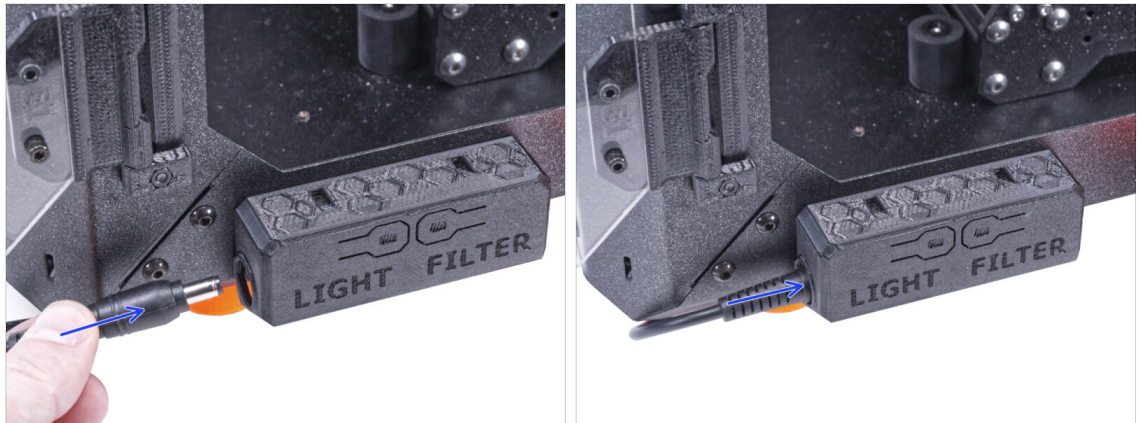

- Connect the external PSU cable to the basic board from the left side.

## STEP 29 Connecting the Power cord: parts preparation



- For the following steps, please prepare:
- Power cord Y-splitter (1x)



### STEP 30 Connecting the Power cord

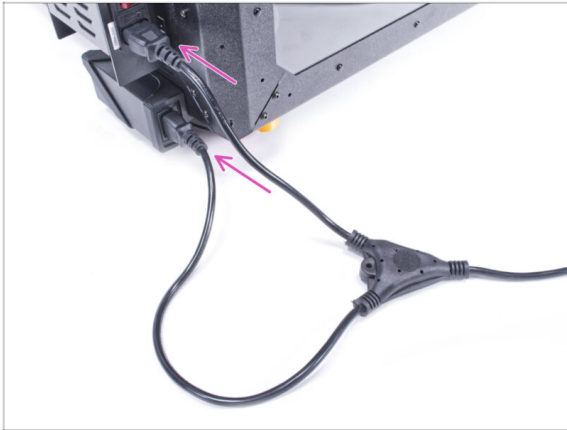

- ◆ Connect the cord plugs to the external PSU and printer PSU.
- ⓘ The order of connection does not matter.

### STEP 31 That's all!

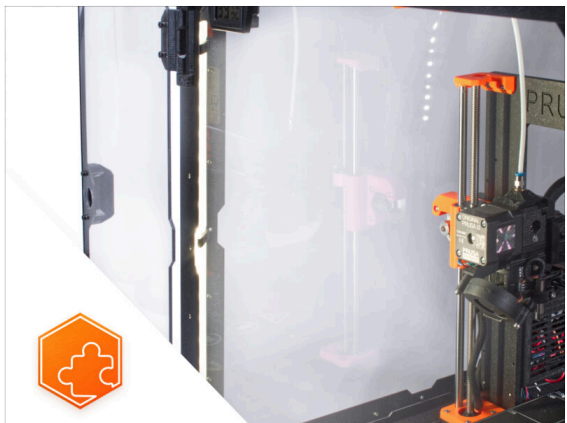
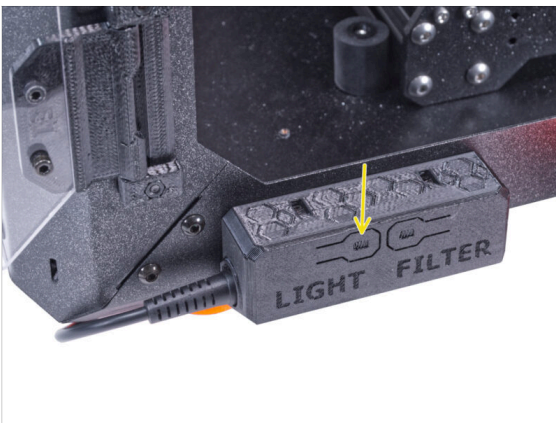

- ◆ Check if it works properly. Press the LIGHT button on the Basic Board Panel and check if the LED lighting inside has turned on.
- ◆ **Nice job!** The LED strip is successfully installed.
- ⓘ The following steps are for installing the White LED strip with the External PSU XP Power model VEC65US24.

**STEP 32** Introduction - External PSU XP Power

- ◆ The following instructions are intended for installing the **White LED strip** with the **External PSU XP Power model VEC65US24** on the **Original Prusa Enclosure**.
- ◆ **Before you start installing the add-on, PRINT OUT ALL NECESSARY PLASTIC PARTS!** The *External-PSU-bracket-XP* and the *Basic-board-cover* are available for download at [Printables.com](https://printables.com)
- ⓘ Note: the *External-PSU-bracket-XP* is intended for mounting the external PSU to the enclosure. However, it is not necessarily required.

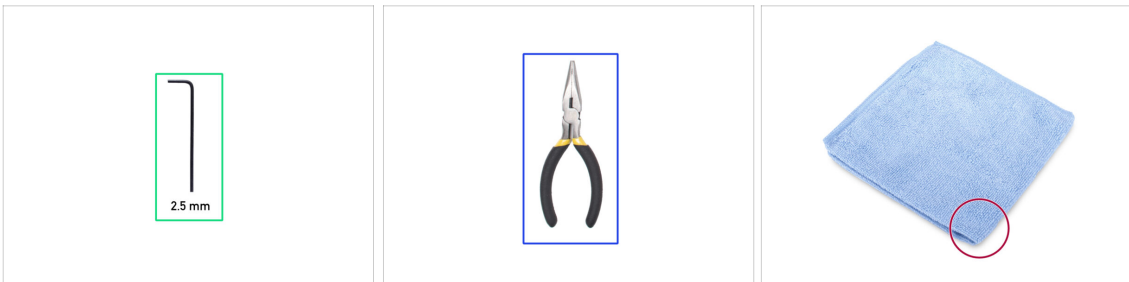
**STEP 33** Tools necessary for this chapter

- ⓘ Tools are not included in the add-on package.
- ◆ **For this chapter, please prepare:**
- ◆ 2.5mm Allen key
- ◆ Needle-nose pliers (*to trim the zip ties*)
- ◆ Piece of cloth or fabric at least 15 x 15 cm

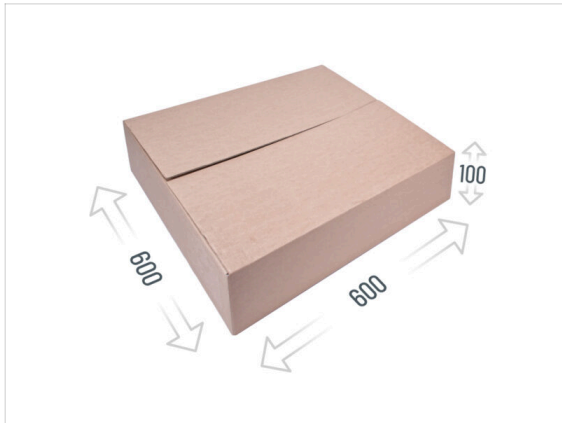
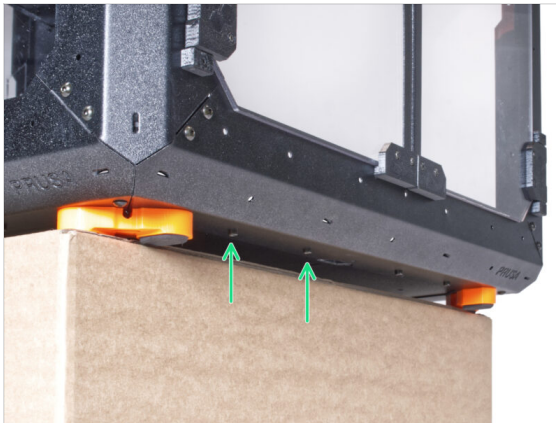
**STEP 34** Suggestion

- ◆ In the following steps, you will need to access the bottom of the enclosure. You achieve this by having one of the bottom edges of the frame extend beyond the work surface. It is recommended to use a cardboard box and put the enclosure on it.
- ◆ The size of the box must be at least 600 x 600 x 100 mm.
- ⓘ Hint: you can use the original cardboard box of the Enclosure packaging.
- ⚠ Do not place the enclosure on the box now. Wait for the instruction.

**STEP 35** Mounting the external PSU (optional): parts preparation

- ⓘ Note: the External-PSU-bracket-XP is intended for mounting the external PSU to the enclosure. However, it is not necessarily required. If you do not want to install the External PSU bracket, go to [Removing the LCD](#).
- ◆ **For the following steps, please prepare:**
  - ◆ External PSU XP Power (1x)
  - ◆ M3x8 screw (1x)
  - ◆ M3nS nut (1x)
  - ◆ External-PSU-bracket-XP (1x)

---

### STEP 36 Mounting the external PSU (optional)



- Insert the M3nS nut into the External-PSU-bracket-XP. Using the Allen key, push the nut all the way into the printed part and align the nut with the hole in the part.

---

### STEP 37 Assembling the external PSU bracket (optional)



- Insert the external PSU into the External-PSU-bracket-XP and push it all the way in. Mind the correct orientation of the PSU.
- Guide the external PSU cable through the channel in the bracket.

## STEP 38 Removing the LCD



- Carefully cut the zip tie securing the LCD cable bundle.
- Release two screws mounting the LCD assembly.
- Disconnect both LCD cables from the LCD.
- Push the LCD cable bundle through the hole in the bottom panel into the enclosure.

## STEP 39 Removing the printer

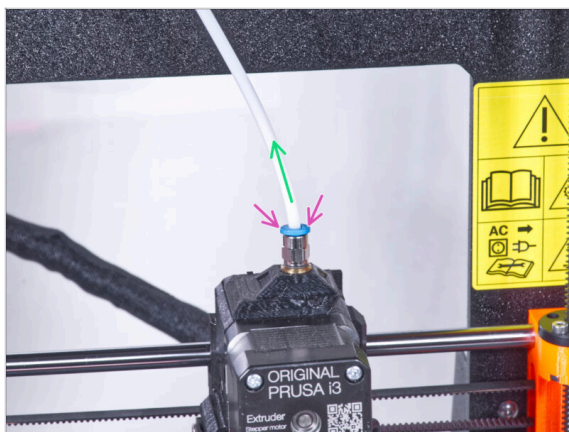

- ⓘ Starting from September 2024, you may receive a new black Fitting M5-4. The assembly and functionality remain identical to the blue one.
- Press down the blue collet on the Fitting QSM-M5.
- Pull out the PTFE tube from the fitting.

## STEP 40 Preparing the printer

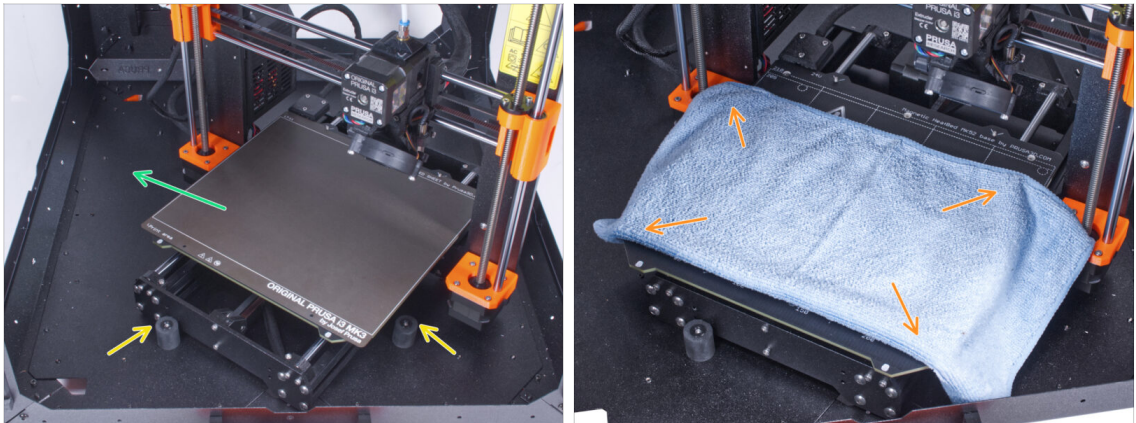

- Place the printer at an angle (as shown in the picture) in the enclosure behind the anti-slip dampers.
- ⓘ It's just a temporary position for the printer. We will adjust the correct position later.
- Take off the steel sheet from the heatbed.
- Spread a piece of cloth on the heatbed.

## STEP 41 Preparing the printer

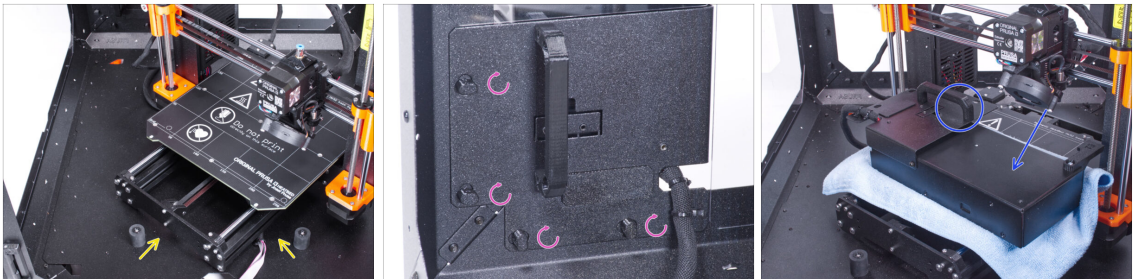

- Place the printer at an angle (as shown in the picture) in the enclosure behind the anti-slip dampers.
- "Unlock" all PSU-locks and grasp the PSU assembly by its handle and remove it from the back panel.
- Place the PSU on the heatbed protected with the cloth. Turn it with the PSU-handle facing upwards.

## STEP 42 Removing the printer

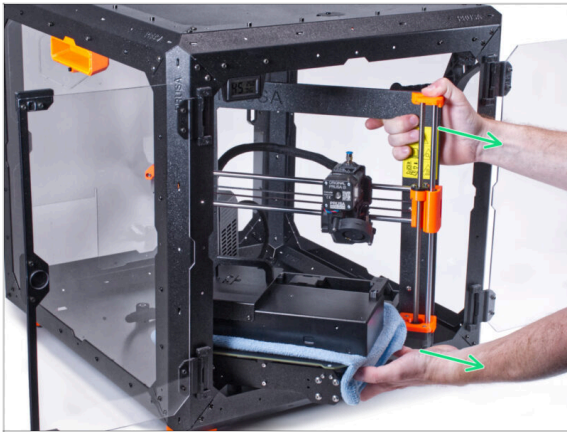

- ◆ Carefully remove the printer from the enclosure.
- ⚠ **Avoid scratching the printer and enclosure.**
- ◆ Place the printer aside. We will need it later on.

## STEP 43 Loosening the bottom panel

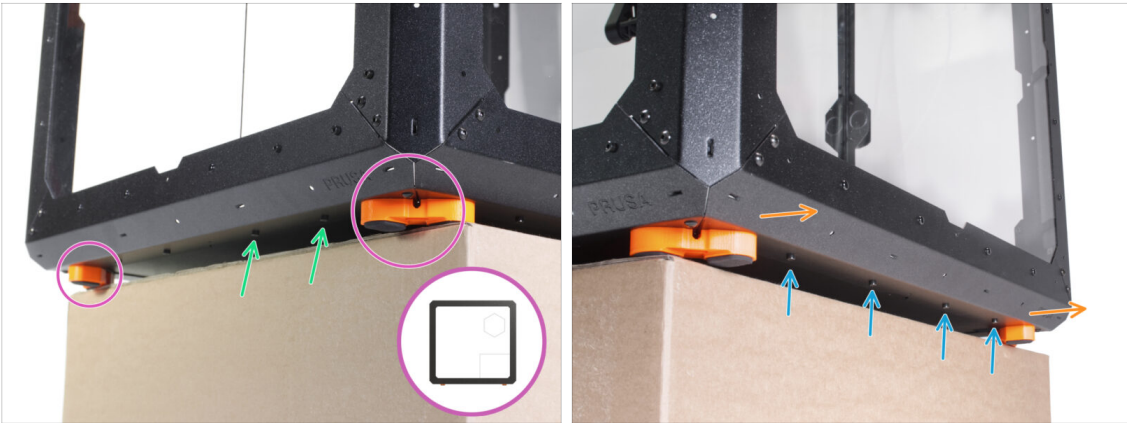

- ◆ Place the enclosure on the cardboard box with the rear side (side with the PSU hole in the back panel) overhanging the box.
- ◆ It is necessary that both feet on the left side stand on one anti-vibration pad. See the detail. **Avoid placing the enclosure directly on the frame.**
- ⚠ **WARNING: Be extra careful and make sure the enclosure is stable and doesn't wobble. Otherwise, the enclosure may fall off the box and hurt you and damage.**
- ◆ From the bottom, release and remove two screws nearest the right corner.
- ◆ In the same way, move the enclosure so that the right side overhangs the box.
- ◆ Release and remove four screws from the bottom profile.
- ◆ Place the enclosure so that all feet are on the surface.

## STEP 44 Mounting the external PSU

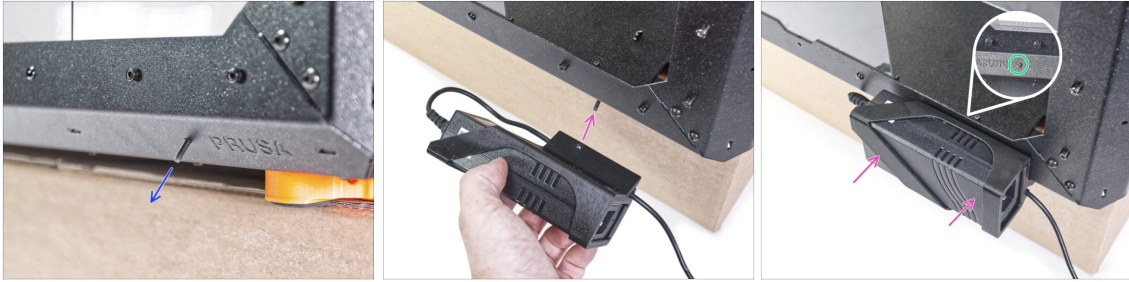

- ◆ From the inside, push the M3x8 screw through the hole in the bottom profile next to the PRUSA logo.
- ◆ Line up the screw hole in the External-PSU-bracket-XP with the protruding screw and attach it to the profile.
- ◆ Tighten the M3x8 screw from inside to mount the external PSU.

## STEP 45 Guiding the external PSU cable

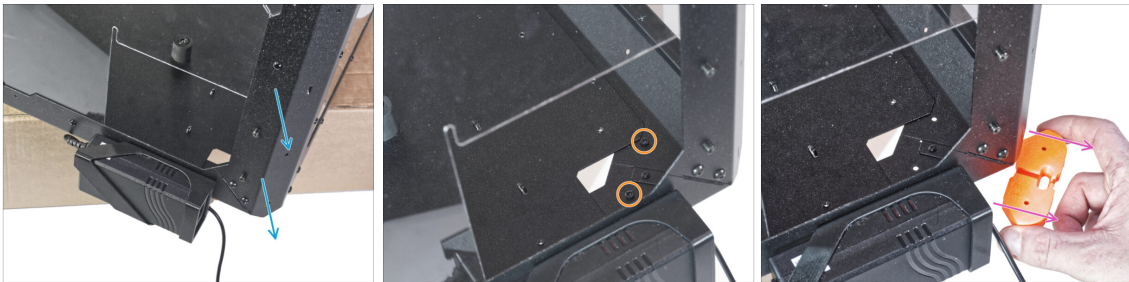

- ◆ Move the rear corner with the PSU over the edge of the box.
- ◆ Through the rectangular hole in the back panel, release two screws mounting the foot to the bottom panel.
- ◆ Remove the foot from the bottom of the enclosure. **Do not discard the part, you will need it again in a while.**

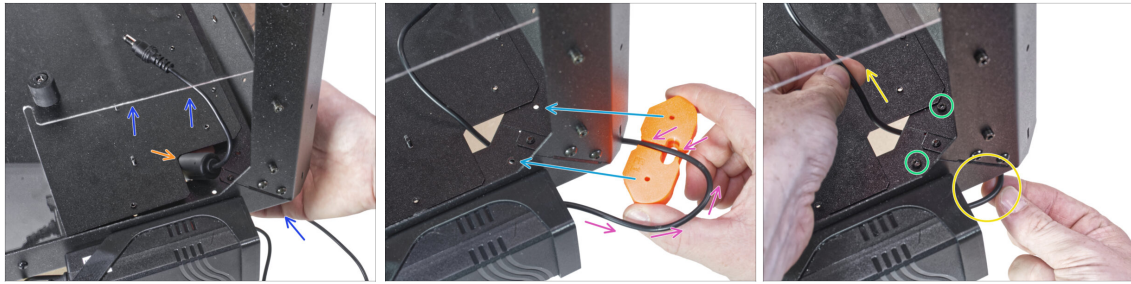

**STEP 46** Guiding the external PSU cable

- ◆ Slightly lift the bottom panel from the bottom side.
- ◆ From the bottom side, push the PSU cable with the ferrite bead (cylindrical part) through the hole in the bottom panel into the enclosure.
- ◆ Guide the PSU cable through the channel in the feet bracket. See the correct orientation of the part.
- ◆ Maintain the orientation of the feet bracket and attach it to its place on the bottom of the enclosure. Line up the holes in the part with the hole in the bottom frame of the enclosure.
  - ◆ Make sure the cable has not fallen out of the channel.
- ◆ Secure the feet bracket with two M3x12 screws.
- ◆ Gently pull the cable back and forth to check for pinching. Keep the excess cable as shown in the picture.

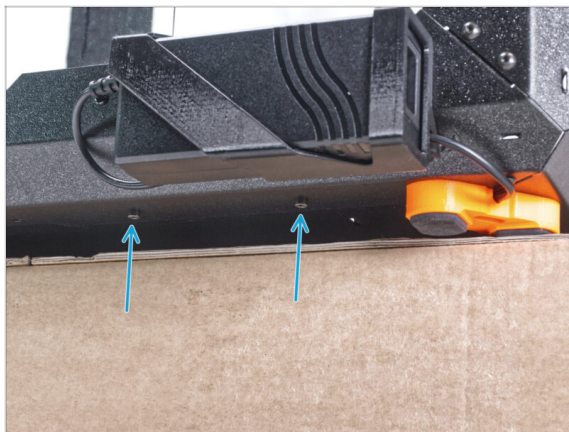
**STEP 47** Tightening the bottom panel

- ◆ Overhang the rear side of the enclosure over the box or table. It is necessary that both feet on the rear side stand on one anti-vibration pad. **Avoid placing the enclosure directly on the frame.**
- ⚠ **WARNING: Be extra careful and make sure the enclosure is stable and doesn't wobble.** Otherwise, the enclosure may fall off the box and hurt you and damage.
- ◆ Secure the bottom panel with two M3x4 screws from the bottom.
- ◆ Place the enclosure so that all feet are on the surface.

## STEP 48 Loosening the bottom panel

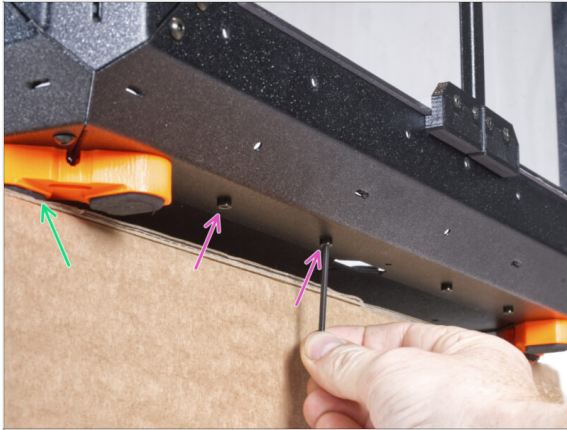

- ◆ Place the enclosure on the cardboard box with the front side overhanging the box.
- ◆ It is necessary that both feet on the front side stand on one anti-vibration pad. **Avoid placing the enclosure directly on the frame.**
- ⚠ **WARNING: Be extra careful and make sure the enclosure is stable and doesn't wobble.** Otherwise, the enclosure may fall off the box and hurt you and damage.
- ◆ From the bottom, release first two screws from the left.
- ◆ Move the left front corner over the edge of the box or table.

## STEP 49 Guiding the external PSU cable

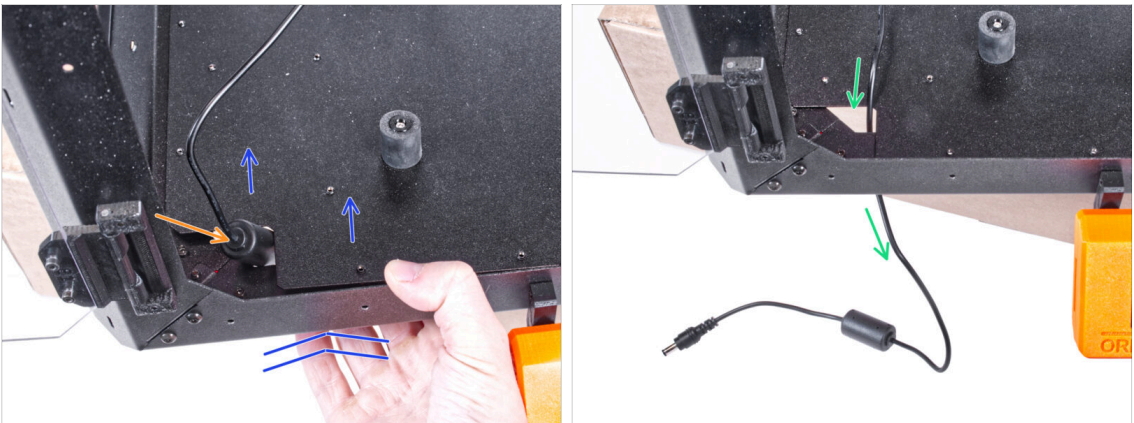

- ◆ Slightly lift the bottom panel from the bottom side.
- ⚠ **Be very careful not to pinch your fingers.**
- ◆ Push the ferrite bead (cylindrical part) on the external PSU cable through the hole.
- ◆ Guide the external cable through the hole and leave it free for now.

## STEP 50 Guiding the external PSU cable



- ◆ Release two screws mounting the feet bracket.
- ◆ Remove the feet bracket from the bottom of the enclosure.
- ◆ There is a cable channel in the feet bracket. Guide the external PSU cable through the channel. Mind the correct orientation of the part.

## STEP 51 Guiding the external PSU cable

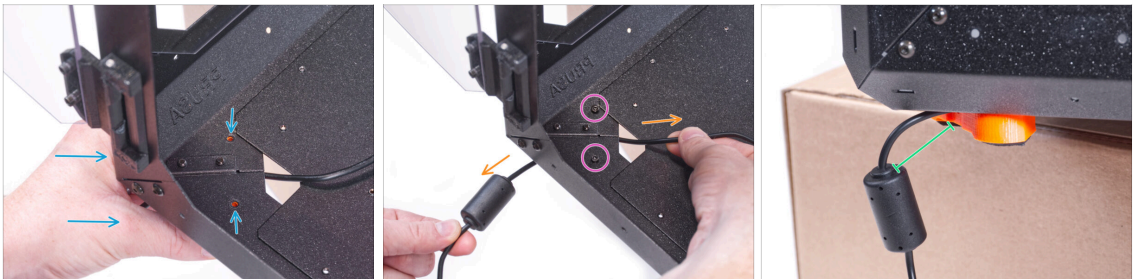

- ◆ Maintain the orientation of the feet bracket and attach it to its place on the bottom of the enclosure. Line up the holes in the part with the hole in the bottom frame of the enclosure.
- ◆ Make sure the cable has not fallen out of the channel.
- ◆ Secure the feet bracket with two M3x12 screws.
- ◆ Gently pull the cable back and forth to check for pinching.
- ◆ Leave the cable extended as shown in the picture. Space between ferrite bead and the feet bracket between 2 - 5 cm.

## STEP 52 Tightening the bottom panel

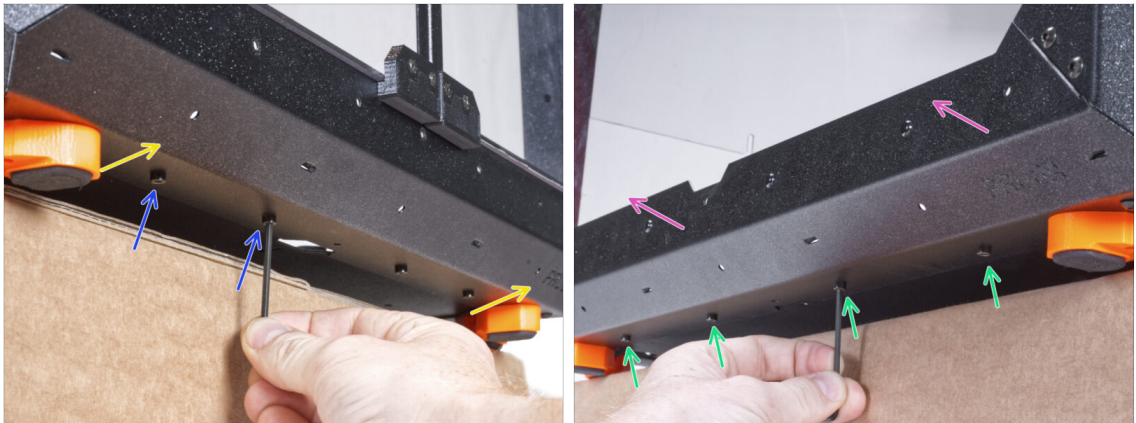

- Overhang the front side of the enclosure over the box or table. It is necessary that both feet on the front side stand on one anti-vibration pad. Avoid placing the enclosure directly on the frame.

⚠ **WARNING: Be extra careful and make sure the enclosure is stable and doesn't wobble. Otherwise, the enclosure may fall off the box and hurt you and damage.**

- Secure the bottom panel with two M3x4 screws from the bottom.
- Overhang the left side of the enclosure over the box or table. It is necessary that both feet on the left side stand on one anti-vibration pad. Avoid placing the enclosure directly on the frame.
- Secure the bottom panel with four M3x4 screws from the bottom.
- Now, place the enclosure on all its feet on the work table and remove the cardboard box. We will not need it anymore.

## STEP 53 Inserting the printer

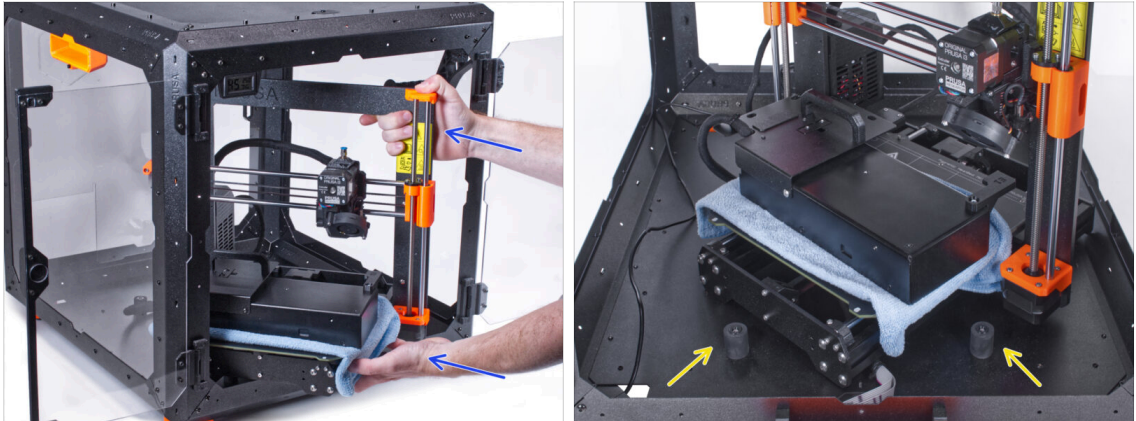

- ◆ Insert the printer into the enclosure. To get the printer into the enclosure, insert its left side first.
  - ⚠ **Avoid scratching the side panels with the printer!**
  - ◆ Place the printer at an angle (as shown in the picture) in the enclosure behind the anti-slip dampers.
  - ⓘ It's just a temporary position for the printer. We will adjust the correct position later.

## STEP 54 Installing the PSU



- ◆ Ensure the PSU-locks are still turned at the same position:
  - ◆ **On the bottom frame**, turn the PSU-locks to the horizontal position.
  - ◆ **On the support**, turn the PSU-lock to the vertical position.
- ◆ Push the PSU through the opening in the back panel.
- ◆ Attach the PSU-holder on the all PSU-locks.
- ◆ Turn all PSU-lock 90° to lock the PSU assembly.

## STEP 55 Guiding the external PSU cable: parts preparation



◆ For the following steps, please prepare:

◆ Zip tie (3x)

## STEP 56 Guiding the external PSU cable



- ◆ Push three zip ties through the perforation in the bottom left profile.
- ◆ Make a loop with the PSU cable according to the picture.
- ◆ Secure the external cable with the first zip tie on the bottom profile.
- ◆ Guide the cable along the bottom profile over the zip ties and tighten the two remaining zip ties.

⚠ **Do not overtighten the zip ties, you can damage the cable.**

**STEP 57** Assembling the LED strip: parts preparation

◆ For the following steps, please prepare:

- ◆ LED diffuser (1x)
- ◆ LED Stick Board (1x)
- ◆ LED Stick Bracket (3x)
- ◆ M3x18 screw (3x)
- ◆ M3n nut (3x)

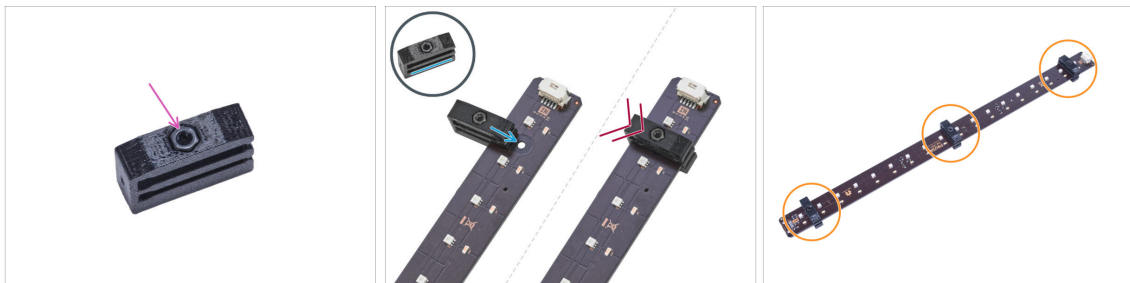
**STEP 58** Assembling the LED strip

- ◆ Insert the M3n nut into each LED Stick Bracket.

⚠ **The nut must be completely embedded in the printed part and flush with the surface of the part. Insufficient embedment of the nut can cause problems when mounting in the enclosure.**

- ◆ Slide the lower slot of the LED Stick Bracket on the LED Stick Board and align the bracket against the first hole in the LED Stick Board closest to the (white) LED stick connector.

⚠ **Avoid sliding the bracket over chips and diodes! It can be fatally damaged.**

- ◆ Push the LED Stick Bracket all the way on the LED Stick Board.
- ◆ Use this procedure for all three LED Stick Brackets.

## STEP 59 Assembling the LED strip

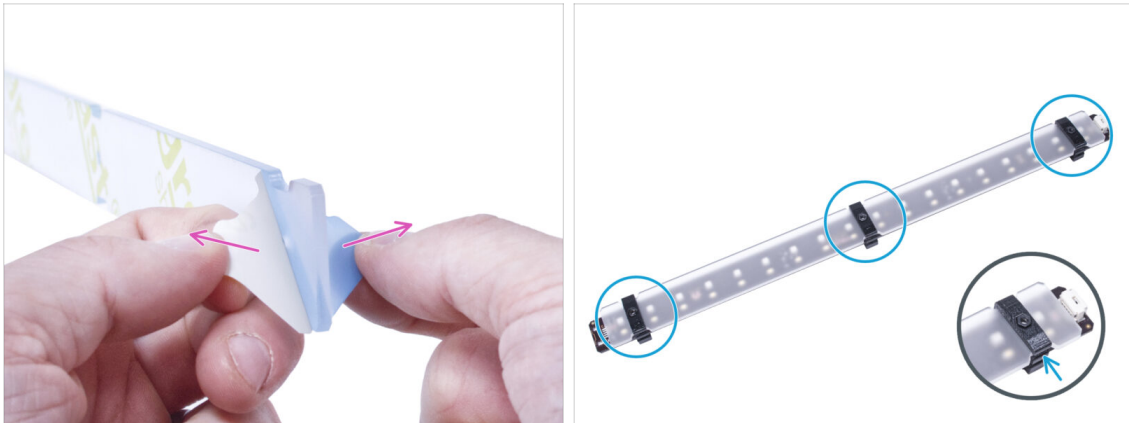

- ◆ Remove the protection films from both sides of the LED diffuser.
- ◆ Push the LED diffuser into the LED Stick Brackets. Use the upper slot.
- ⓘ The orientation of the LED diffuser doesn't matter. The part is symmetrical.

## STEP 60 Mounting the LED strip



- ◆ From the outside, insert three M3x18 screws into the holes in the front left support profile.
- ◆ From the inside of the enclosure, attach the LED strip assembly on the M3x18 screws.
- ◆ The LED connector must be facing down.
- ◆ Tighten all three M3x18 screws to secure the LED strip assembly.



## STEP 61 Connecting the LED strip: parts preparation



● For the following steps, please prepare:

● LED cable (1x)

● Zip tie (1x)

## STEP 62 Connecting the LED cable



● Connect the LED cable to the connector on the bottom of the LED strip.

● Guide the LED cable through the hole in the bottom panel out of the enclosure.

● Guide the zip tie through the perforation in the bottom left profile and tight together the LED cable and the external PSU cable using the zip tie.

⚠ **Do not overtighten the zip ties, you can damage the cable.**

● Rearrange position of the printer like in the picture. Place it in the center of the enclosure and adjust the correct position.

**STEP 63** Mounting the LCD: parts preparation

◆ For the following steps, please prepare:

- ◆ LCD assembly (1x)
- ◆ M3x8 screw (2x)
- ◆ Zip tie (1x)

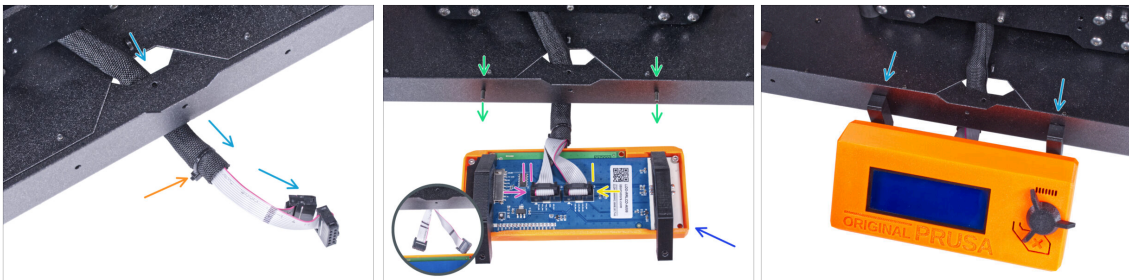
**STEP 64** Mounting the LCD

- ◆ Guide the LCD cable through the cutout in the bottom panel.
- ◆ Secure the textile sleeve on the cable bundle with the zip tie. **Do not over tighten the zip tie**, it may cut the cables!
- ◆ From the inside, push two M3x8 screws through the bottom profile.
- ◆ Place the LCD assembly close to the LCD cables, like in the picture. Mind the same orientation of the LCD as in the picture. See the LCD-supports for better understanding.

⚠ **Note that both cables are marked with stripes on one side. Correct connection order is important!**

- ◆ Connect the LCD cable marked with **TWO STRIPES** to the **left slot** (called EXP2) on the LCD controller.
- ◆ Connect the LCD cable marked with **ONE STRIPE** to the **right slot** (called EXP1) on the LCD controller.
- ◆ Slide the LCD assembly onto the two M3x8 screws in the frame and tighten them.

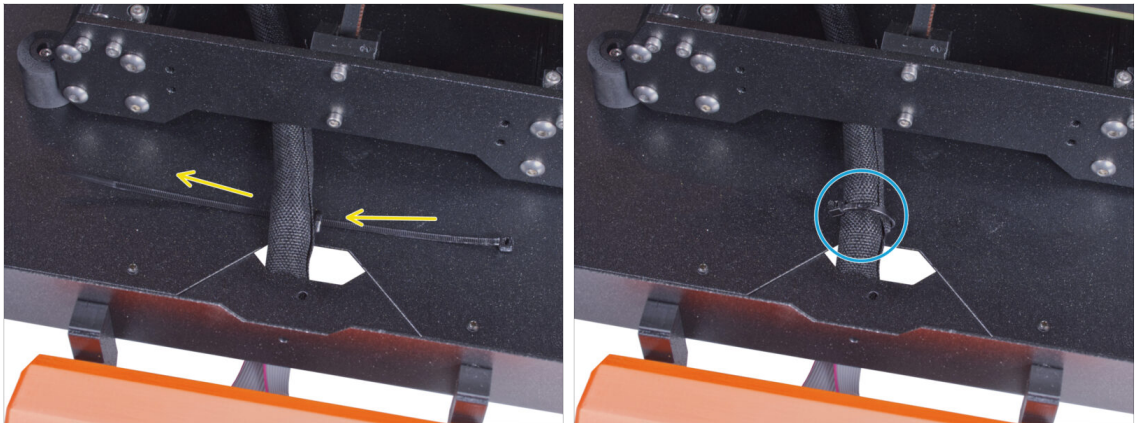
**STEP 65** Securing the LCD cable

- Guide the zip tie through the perforation in the bottom panel and under the LCD cable bundle.
- Tighten the zip tie to secure the LCD cable bundle. **Do not over tighten the zip tie, it may cut the cables!**

**STEP 66** Installing the basic board: parts preparation

● **For the following steps, please prepare:**

- Basic Board Cover (1x)
- Basic board (1x)
- M3x12 screw (2x)
- M3w serrated lock washer (2x)
- M3nS nut (2x)

## STEP 67 Installing the basic board



- ◆ Mount the M3nS nut on the M3x12 screw. Attach it in a few threads on the tip of the screw.
- ◆ Push the screw with the nut all the way into the same shape hole inside the Basic Board Cover.
- ◆ Remove the screw from the nut.

## STEP 68 Installing the basic board



- ◆ Use the same procedure for both slots in the Basic Board Cover.

## STEP 69 Connecting the LED cable

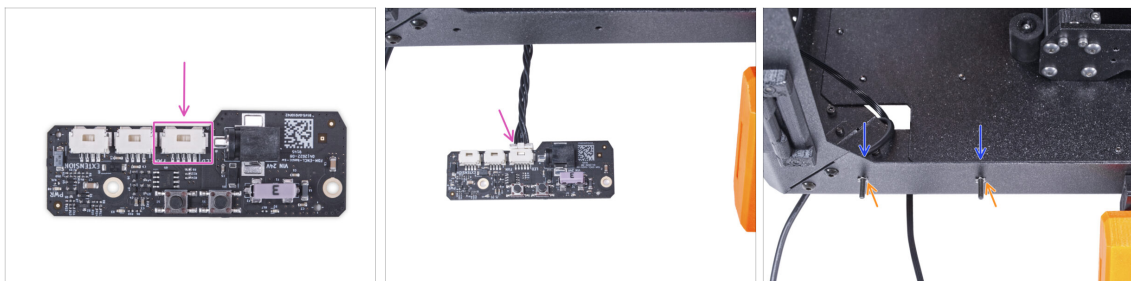

- ◆ Connect the LED cable to connector on the basic board.
- ◆ From inside the enclosure, insert two M3x12 screw through the front profile.
- ◆ Attach two M3w serrated lock washer on the screws.

## STEP 70 Mounting the basic board

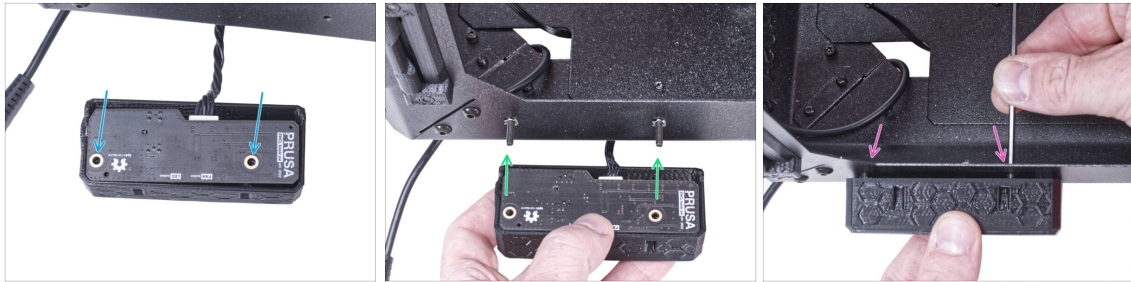

- ◆ Insert the basic board into the Basic Board Cover and align the holes on both parts.
- ◆ Take the basic board assembly and align the holes with the screws in the profile.
- ◆ Attach the basic board assembly to the screws and tighten the screws from the inside.

## STEP 71 Connecting the external PSU

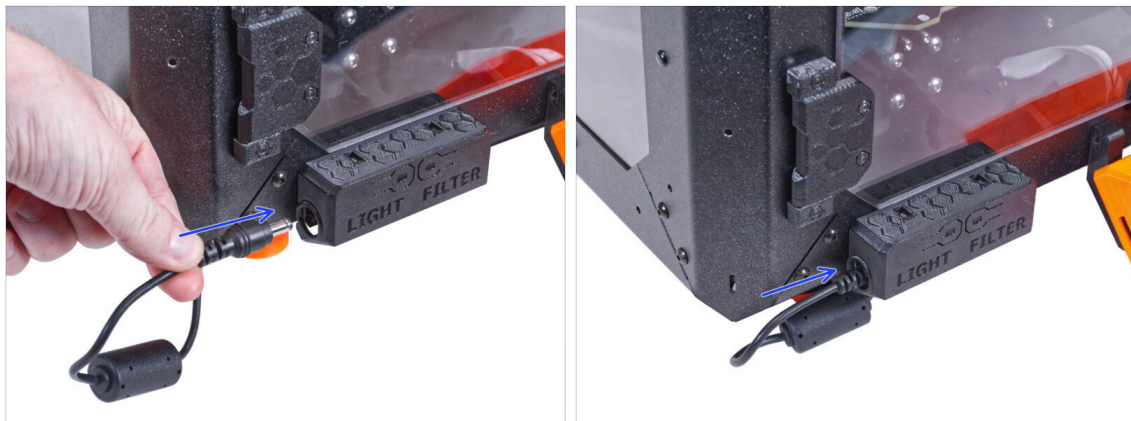

- ◆ Connect the external PSU cable to the basic board from the left side.

---

## STEP 72 Connecting the PTFE tube

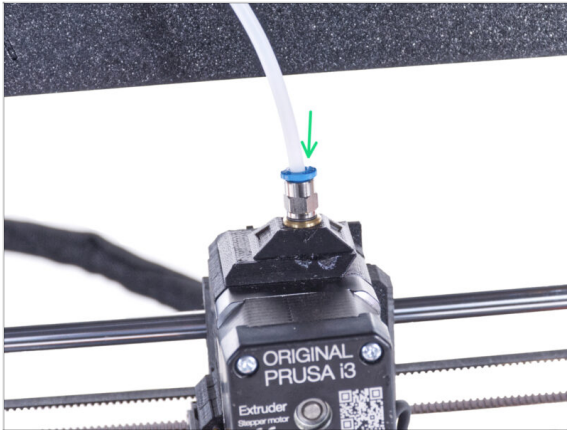

- ⓘ Starting from September 2024, you may receive a new black Fitting M5-4. The assembly and functionality remain identical to the blue one.
- ◆ Insert the free end of the PTFE tube to the Fitting QSM-M5 on the extruder. Insert it all the way down.

---

## STEP 73 Connecting the Power cord: parts preparation



- ◆ **For the following steps, please prepare:**
- ◆ Power cord Y-splitter (1x)

---

### STEP 74 Connecting the Power cord

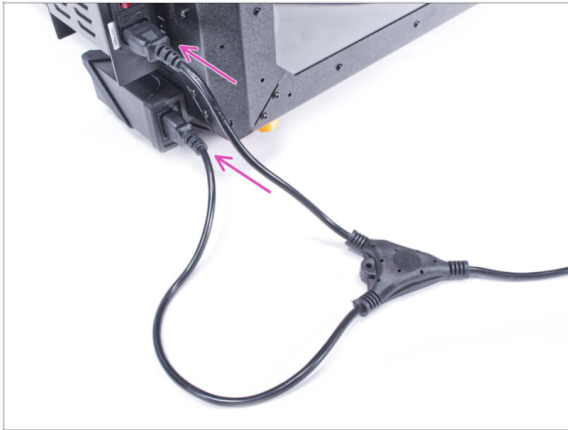

- ◆ Connect the cord plugs to the external PSU and printer PSU.
- ⓘ The order of connection does not matter.

---

### STEP 75 That's all!

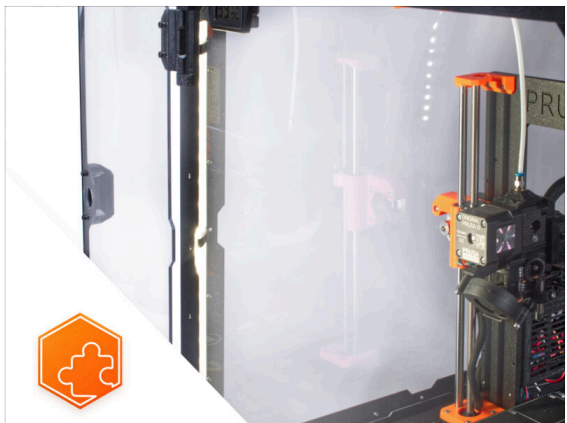
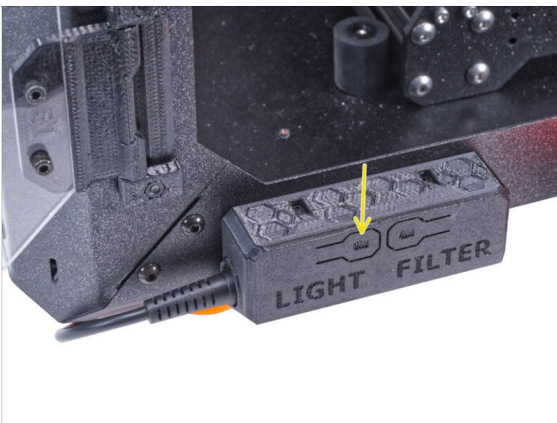

- ◆ Check if it works properly. Press the LIGHT button on the Basic Board Panel and check if the LED lighting inside has turned on.
- ◆ **Nice job!** The LED strip is successfully installed.





---





