

Table of Contents

1. Introduction	5
Step 1 - Preparing the MMU2S upgrade kit	6
Step 2 - All the required tools are included	6
Step 3 - Use labels for reference	7
Step 4 - View high resolution images	7
Step 5 - Printed parts - versioning	8
Step 6 - Printed parts - STL files	8
Step 7 - We are here for you!	9
Step 8 - Pro tip: inserting the nuts	9
Step 9 - Treat yourself!	10
Step 10 - How to successfully finish the assembly	11
Step 11 - Select the correct printer type	12
2. MK3S+ extruder disassembly	13
Step 1 - Preparing the printer	14
Step 2 - Releasing the cable bundle	14
Step 3 - Unplugging the IR filament sensor cable	15
Step 4 - X-carriage-back disassembly	15
Step 5 - FS-cover and hotend fan disassembly	16
Step 6 - Extruder-body release	16
Step 7 - Extruder-idler disassembly	17
Step 8 - Extruder-idler disassembly	17
Step 9 - Haribo time?	18
Step 10 - Testing, testing!	18
3. MK3S+ extruder upgrade	19
Step 1 - Extruder-body parts preparation	20
Step 2 - Adapter-mmu2-assembly	20
Step 3 - IR filament sensor parts preparation	21
Step 4 - IR filament sensor parts preparation	21
Step 5 - IR filament sensor assembly	22
Step 6 - IR filament sensor assembly	22
Step 7 - IR filament sensor assembly	23
Step 8 - Mounting the IR filament sensor	23
Step 9 - X-carriage retightening	24
Step 10 - Hotend fan assembly	24
Step 11 - Extruder-idler parts preparation	25
Step 12 - Bearing assembly	25
Step 13 - Extruder-idler-mmu2s assembly	26
Step 14 - Extruder-idler-mmu2s assembly	26
Step 15 - X-carriage-back reassembly	27
Step 16 - Textile sleeve parts preparation	27
Step 17 - Tightening the textile sleeve	28
Step 18 - It's Haribo time!	29
Step 19 - E-axis is finished!	30
4. Idler body assembly	31
Step 1 - Tools necessary for this chapter	32
Step 2 - Idler parts preparation	32
Step 3 - Idler bearings assembly (part 1)	33
Step 4 - Idler bearings assembly (part 2)	33
Step 5 - Idler nuts assembly	34
Step 6 - Idler centre bearing assembly	34

Step 7 - Final check	35
Step 8 - Idler-body parts preparation	35
Step 9 - Inserting M3nS nuts into idler-body	36
Step 10 - Inserting the idler in the idler-body	36
Step 11 - Idler motor assembly (part 1)	37
Step 12 - Idler motor assembly (part 2)	37
Step 13 - Idler motor assembly (part 3)	38
Step 14 - It's Haribo time!	38
Step 15 - Final check	39
5. Pulley body assembly	40
Step 1 - Tools necessary for this chapter	41
Step 2 - Pulley-body parts preparation	41
Step 3 - Pulley-body assembly (part 1)	41
Step 4 - Pulley-body assembly (part 2)	42
Step 5 - Pulley motor parts preparation	42
Step 6 - MMU1 to MMU2S upgrade (part 1)	43
Step 7 - MMU1 to MMU2S upgrade (part 2)	43
Step 8 - MMU1 to MMU2S upgrade (part 3)	44
Step 9 - Pulley motor assembly (part 1)	44
Step 10 - Pulley motor assembly (part 2)	45
Step 11 - Pulley adjustment	45
Step 12 - Front-PTFE-holder parts preparation	46
Step 13 - Front-PTFE-holder assembly	46
Step 14 - Selector-finda parts preparation	47
Step 15 - Selector-finda assembly (part 1)	47
Step 16 - Selector-finda assembly (part 2)	48
Step 17 - Selector motor parts preparation	48
Step 18 - Nut assembly	49
Step 19 - Selector-front-plate assembly	49
Step 20 - Blade-holder parts preparation	50
Step 21 - Blade-holder assembly	50
Step 22 - Selector motor assembly (part 1)	51
Step 23 - Selector motor assembly (part 2)	51
Step 24 - SuperFINDA sensor parts preparation	52
Step 25 - SuperFINDA sensor assembly	52
Step 26 - MMU2S unit parts preparation	53
Step 27 - MMU2S unit assembly (part 1)	53
Step 28 - MMU2S unit assembly (part 2)	54
Step 29 - MMU2S unit assembly (part 3)	54
Step 30 - MMU2S unit assembly (part 4)	55
Step 31 - MMU2S unit assembly (part 5)	55
Step 32 - Tensioning parts preparation	56
Step 33 - Tensioning system assembly	56
Step 34 - It's Haribo time!	57
Step 35 - Final check of the MMU2S unit	57
6. Electronics and MMU2S unit assembly	58
Step 1 - Tools necessary for this chapter	59
Step 2 - Electronic parts preparation	59
Step 3 - Electronics assembly	60
Step 4 - Cables preparation	60
Step 5 - Connecting the cables	61
Step 6 - Cable management parts preparation	61
Step 7 - Cable management (part 1)	62
Step 8 - Cable management (part 2)	62

Step 9 - Cable management (part 3)	63
Step 10 - Cable management (part 4)	63
Step 11 - PTFE tubes parts preparation	64
Step 12 - PTFE tubes assembly (part 1)	64
Step 13 - PTFE tubes assembly (part 2)	65
Step 14 - PTFE tubes assembly (part 3)	65
Step 15 - Frame holder parts preparation	66
Step 16 - Frame holder assembly	66
Step 17 - MMU2S unit is finished!	67
Step 18 - PTFE tube parts preparation	67
Step 19 - PTFE tube assembly	68
Step 20 - Assembling the MMU2S unit (part 1)	68
Step 21 - Assembling the MMU2S unit (part 2)	69
Step 22 - Assembling the MMU2S unit (part 3)	69
Step 23 - Connecting the extruder and MMU2S unit	70
Step 24 - Connecting the electronics	70
Step 25 - Connecting the electronics	71
Step 26 - Connecting the extruder MK3S/+ (optional)	71
Step 27 - Connecting the electronics MK3S/+	72
Step 28 - Connecting the electronics MK2.5S	73
Step 29 - Connecting the electronics MK2.5S (optional)	74
Step 30 - Connecting the electronics	74
Step 31 - It's Haribo time!	75
Step 32 - Final check!	75
7. Spool holder and buffer assembly	76
Step 1 - Tools necessary for this chapter	77
Step 2 - Cleaning the spool holder base (optional)	77
Step 3 - Sticking foam pads	78
Step 4 - Assembling the spool shafts	78
Step 5 - Assembling the spool shafts	79
Step 6 - Assembling the spool holder (part 1)	79
Step 7 - Assembling the spool holder (part 2)	80
Step 8 - Buffer parts preparation	80
Step 9 - New buffer parts	81
Step 10 - Buffer parts preparation (new version)	82
Step 11 - Buffer assembly - printer part (new version)	83
Step 12 - Buffer assembly - spools part (new version)	83
Step 13 - WARNING: tightening the parts (new version)	84
Step 14 - Adding the spacers and hooks (new version)	84
Step 15 - Buffer parts preparation (old version)	85
Step 16 - Buffer assembly - printer part (old version)	86
Step 17 - Buffer assembly - spools part (old version)	86
Step 18 - WARNING: tightening the parts (old version)	87
Step 19 - Adding the spacers on both sides (old version)	87
Step 20 - Adding the PTFE tubes (both versions)	88
Step 21 - It's Haribo time!	88
Step 22 - Final check	89
8. Preflight check & Calibration	90
Step 1 - SuperPINDA calibration preparation (optional)	91
Step 2 - SuperPINDA adjustment (part 1)	91
Step 3 - SuperPINDA adjustment (part 2)	92
Step 4 - SuperPINDA adjustment (part 3)	92
Step 5 - Two types of the MMU firmware	93
Step 6 - Download the necessary software	94

Step 7 - Download the new firmware	94
Step 8 - Updating both firmwares using PrusaSlicer	95
Step 9 - Adding MMU2S settings to the PrusaSlicer	95
Step 10 - Turning the MMU on and reset	96
Step 11 - IR filament sensor calibration	96
Step 12 - IR filament sensor calibration 2	97
Step 13 - IR filament sensor calibration 3	98
Step 14 - SuperFINDA sensor calibration preparation	98
Step 15 - SuperFINDA calibration	99
Step 16 - Preparing to load filaments for the test setup.	100
Step 17 - Connecting the rear PTFE tubes	100
Step 18 - Loading a filament into the buffer	101
Step 19 - Loading a filament into MMU2S	101
9. First flight	102
Step 1 - Z axis and first layer calibration (optional)	103
Step 2 - Loading a sample G-code to the printer	103
Step 3 - Start the print	104
Step 4 - Handbook and Troubleshooting	104
Step 5 - Printable 3D models	105
Step 6 - G-code preparation / Custom model preparation	105
Step 7 - Making your own Multi-material models	106
Step 8 - Join PrusaPrinters!	106
Step 9 - It finally is a Haribo time!	107
Manual changelog MMU2S	108
Step 1 - Versions history	109
Step 2 - Changes to the manual (1)	109

1. Introduction



STEP 1 Preparing the MMU2S upgrade kit



- Welcome to the tutorial on how to upgrade your single material Original Prusa i3 to **Original Prusa i3 with MMU2S**.
- **Directly compatible printers:**
 - Original Prusa i3 MK3S+, MK3S and MK2.5S
- **Incompatible printers:**
 - Original Prusa MK3 or MK2.5, older MMU2S packages included extruder upgrade, if yours does not, please upgrade first to **MK3S+ extruder**.
 - Original Prusa i3 MK2/S (*please see this [article about upgrading to the unofficial version, MK2.5S+](#)*)
 - Original Prusa i3 MK2/S MMU1 (upgrade is no longer available)
- ⓘ For those upgrading MMU2 to MMU2S, please follow chapters 2 and 3 to rebuild the extruder, then skip to [chapter 6 \(Step 23\)](#), assemble buffer in [chapter 7](#) and calibrate printer according to chapter 8.

STEP 2 All the required tools are included



- The kit includes:
 - Needle-nose pliers (1x)
 - Philips screwdriver (1x)
 - Allen key (4x)
 - Universal wrench (1x) *older units include a side wrench 8 mm*
- ⓘ No soldering is required.
- ⓘ No wire crimping is required.
- ⓘ The colour of the tools might differ.

STEP 3 Use labels for reference



- i** Most of the labels are scaled 1:1 and can be used to identify the part :-)
- i** Label on the picture is used as an example, yours might be different.

STEP 4 View high resolution images

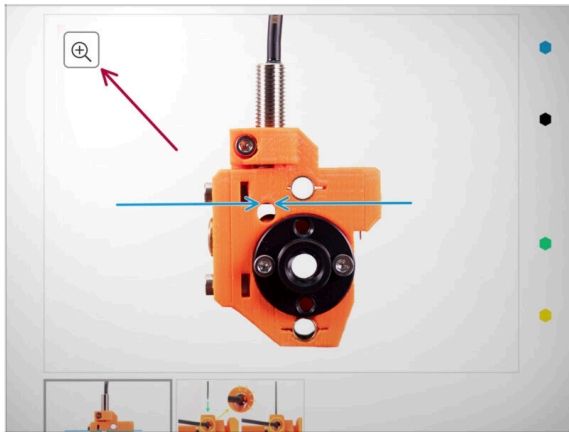

- ◆** When you browse the guide on help.prusa3d.com, you can view the original images in high resolution for clarity.
- ◆** Just hover your cursor over the image and click the Magnifier button ("View original") in the top left corner.

STEP 5 Printed parts - versioning

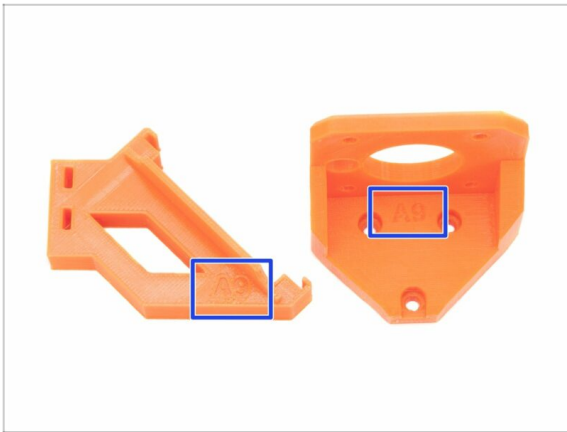

- ◆ The **MMU2S upgrade** has most of the 3D printed parts marked with their version.
- ⓘ In case you have issues while printing or assembling certain printed part, please try to find this label and tell it to our support team.
- ⓘ Printed parts in the picture are used as an example, yours will be different.

STEP 6 Printed parts - STL files

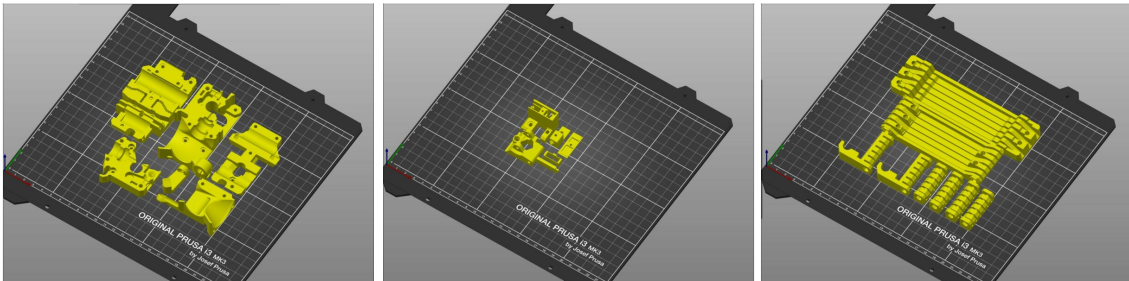

- ⚠ **All parts necessary to finish this upgrade are included in the kit. Only exception is that if you are upgrading MMU2 to MMU2S and decided to print the parts on your own.**
- ◆ In case some parts get broken during the assembly, you can reprint them. Please check all plastic parts before starting your build to make sure there are no issues.
- ◆ The package with all MMU2S STL files is available at prusa3d.com/prusa-i3-printable-parts/
- ⓘ The recommended material is PETG.
- ⓘ For printing individual parts, it is recommended to use PrusaSlicer with 0.2 mm layer height, GRID infill at 20%, no supports!

STEP 7 We are here for you!

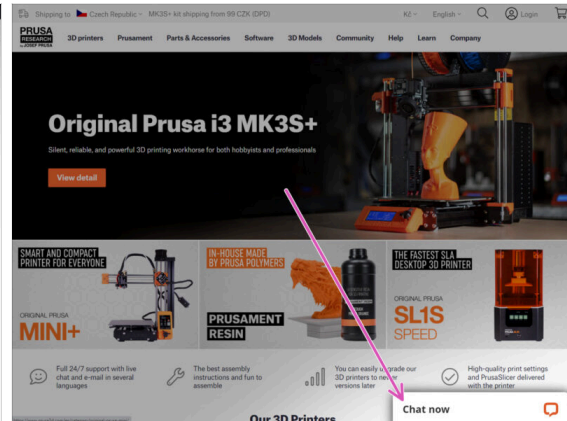
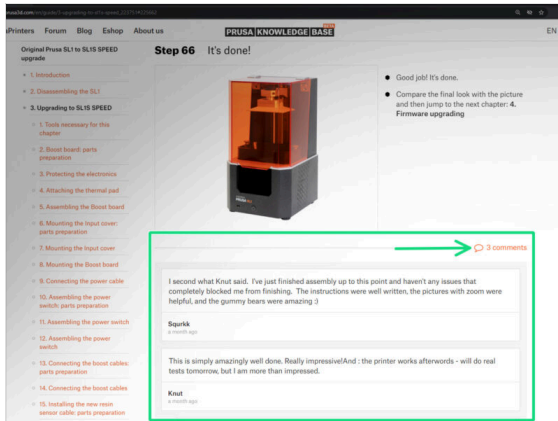

- 🛡️ Lost in the instructions, missing screws or a cracked printed part? **Let us know!**
- 🛡️ You can contact us using following channels:
 - 🟢 Using comments under each step.
 - 🟣 Using our 24/7 live chat at shop.prusa3d.com
 - 🛡️ Writing an email to info@prusa3d.com

STEP 8 Pro tip: inserting the nuts



- 🛡️ 3D printed parts are very precise, however, there still might be a tolerance in the printed part and same goes for the size of the nut.
- 🛡️ Therefore it might happen, that the nut won't fit easily in or might be falling out. Let's see, how to fix it:
 - 🟢 **Nut won't fit in:** use a screw with a thread along its entire length (typically: M3x10, M3x18) and screw it from the opposite side of the opening. While tightening the screw, the nut will be pulled in. Remove the screw afterwards.
 - 🛡️ **Nut keeps falling out:** Use a piece of tape to fix the nut temporarily in place, as soon as you insert the screw in, you can remove the tape. *Using glue isn't recommended as it can partly reach into the thread and you won't be able to tighten the screw properly.*
- 🛡️ Every time we recommend to use the "screw pulling technique", you will be reminded with Joe's avatar ;)
- 📄 **i** Parts in the pictures are used as an example.

STEP 9 Treat yourself!



- ◆ Building a 3D printer is a challenge unlike any other and you should treat yourself for every milestone you reach. That is why a bag of Haribo Bears is included!
- ⚠ **The biggest issue from the previous builds (MK3, MK2/S) which we had to address was inadequate bear consumption. Many of you didn't have enough bears for all chapters, some even ate them all before they started!**
- ◆ I'm glad to announce that **after countless weeks of academic research** (hundreds of eaten bears), we came to a solution! Thank us later ;)
- ◆ At the end of each chapter, you will be told a specific amount of bears to consume.
- ◆ Eating more or less bears than prescribed in the manual might lead to fatigue or nausea. Please consult a professional in the closest candy store.
- ⚠ **Hide the Haribo for now!** From our experience an unattended bag with sweets tends to suddenly disappear. We are currently investigating this phenomenon.

STEP 10 How to successfully finish the assembly

Step 16 X-carriage assembly



⚠ For the following nut insertion USE A SCREW. THAT'S AN ORDER!!! Seriously, use a screw to pull the nuts in, both have to be properly seated in the X-carriage.

- Take both M3n nuts and using pliers (or screw) push them in the X-carriage, then using a screw from the other side, pull them all the way in.
- Don't forget to remove the screw.
- Take all four M3n5 nuts and insert them in. Ensure correct alignment using the Allen key.

ⓘ From now on, keep in mind the nuts are inside, avoid rotating the X-carriage "downwards, or the nuts might fall out."

Add a comment

STEP 17 Aligning the smooth rods



⚠ IMPORTANT: proper alignment of the smooth rods is crucial to reduce noise and overall friction.

- Ensure all M3x10 screws on Y-holders are released, so the printed parts are able to move.
- Move the Y-carriage back and forth across the entire length of the smooth rods to align them.
- Then move the carriage to the front plate and tighten all screws in the front-Y-holders.
- Move the Y-carriage to the rear plate and tighten all screws in the back-Y-holders.

10 comments

Anything I can do if the M3x10 screws on the rear plate (short extruders) holding the rear Y-holders are not tightening all the way? They are stripped and just keep rotating. The rear Y-holders wiggle a little.

Alex Wilkie - January 4

Hi Alex, are you able to release the screws and take them out? Both nuts and screws, can be replaced from spare bag if needed.

Jakub Dolzal - January 5

⚠ To successfully finish the assembly please follow all these:

- **Always read all the instructions at current step first**, it will help you to understand, what you need to do.
- **Don't follow pictures only!** It is not enough, the written instructions are as brief as they could be. Read them.
- **Read the comments** from the other users, they are great source of ideas. We read them too and based on your feedback improve the manual and the entire assembly.
- **Use a reasonable force**, the printed parts are tough, but not unbreakable. If it doesn't fit, check your approach twice.
- **Eat the gummy bears as instructed!** Disobedience won't be tolerated :D
- **Most important: Enjoy the build, have fun.** Cooperate with your kids, friends or partners. *However, we take no responsibility for possible fights ;)*

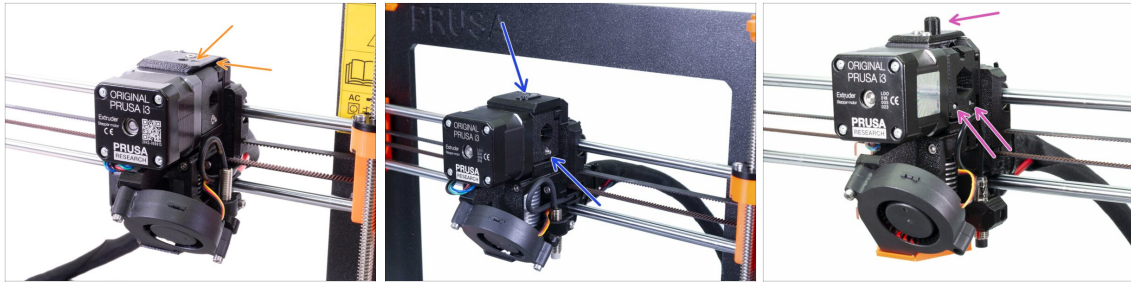
STEP 11 Select the correct printer type

! **IMPORTANT:** Make sure you have selected correct printer from below!

- ◆** **MK3S+** design with sharp edges and a symbol of an arrow on the top cover. A partial extruder disassembly is required. You have to replace just a few parts. Please follow [2A. MK3S+ extruder disassembly](#)

(i) If you start with the new **MK3S+** printer, then follow chapters with this type of printer (**chapters "A"**)
- ◆** **MK3S/MK2.5S** design without "chimney" and one idler screw requires **partial extruder disassembly**. You have to replace just few parts. Please follow [2B. MK3S/MK2.5S extruder disassembly](#)

(i) If you start with the **MK3S/MK2.5S** printer, then follow chapters with this type of the printer (**chapters "B"**)
- ◆** **MK3/MK2.5** design with "chimney" and two idler screws requires **complete extruder disassembly**. You have to use new printed parts. Please follow [2C. MK3/MK2.5 extruder disassembly](#)

(i) If you start with the old **MK3/MK2.5** printer, then follow the chapters with this type of the printer (**chapters "C"**)

2. MK3S+ extruder disassembly



STEP 1 Preparing the printer

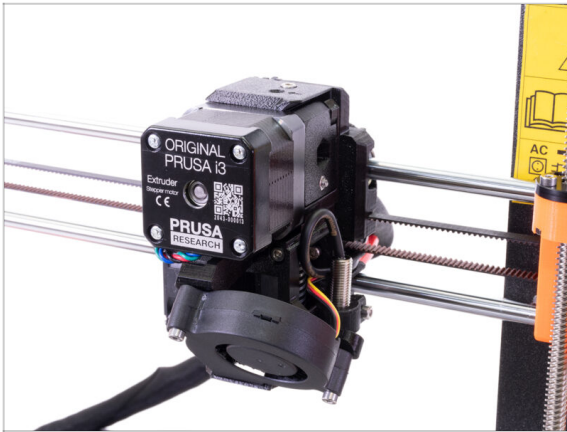

⚠ Before you start, make sure that:

- the filament is unloaded from the hotend
- the printer is properly cooled down
- print head is at a height it is easily accessible at.
- the printer is unplugged
- you removed the steel sheet

⚠ This chapter is dedicated *only* to the **MK3S+ owners.**

STEP 2 Releasing the cable bundle



- ① MK3S+ and MK3S+ MMU2S extruders are very similar, just a few parts will be changed. The most important is, we need to release the cable bundle.
- Using an Allen key release the M3x40 screw and open the door.
- Release two M3x10 screws and remove the extruder-cable-clip. On older printers cut the zip tie.
- In case there are zip ties inside the Einsy-case, carefully remove them.
- Remove the zip ties on the cable holder.
- Keep the textile sleeve on the cables, but make sure the cable can slip inside. It might be twisted around other cables, in such case, you have to remove the sleeve.

STEP 3 Unplugging the IR filament sensor cable

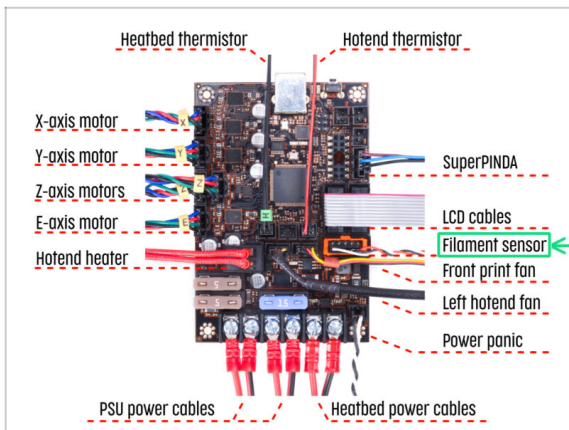

- ◆ Carefully unplug the IR filament sensor cable and make sure it is free inside the electronics box.
- ⓘ We need to gently pull the **IR filament sensor cable** slightly towards the extruder as the sensor will be in a different position. Make sure the entire path of the cable is free. However there is no need for a complete disassembly.

STEP 4 X-carriage-back disassembly

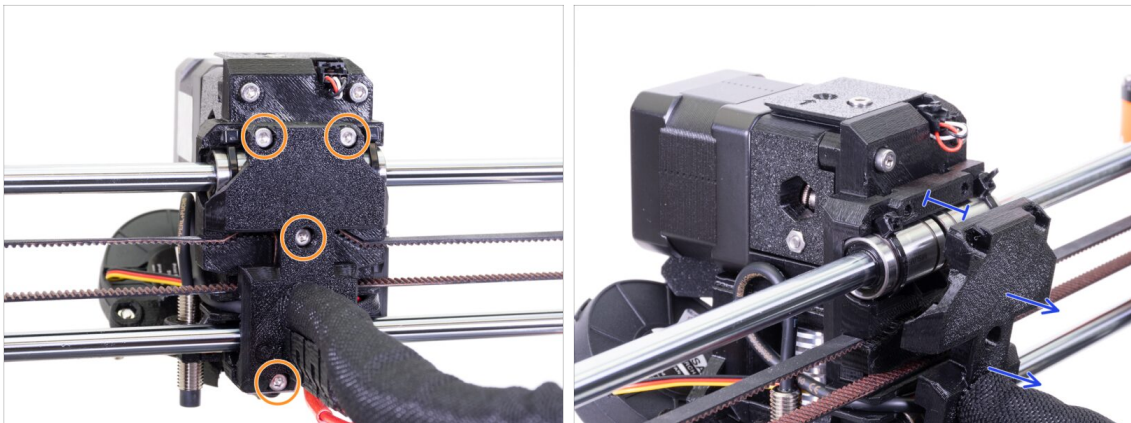

- ◆ Release all four M3x10 screws on the X-carriage-back. You can keep them in the printed part.
- ◆ Move the X-carriage-back back about 10 mm (0.4 inch) to ensure the cables can move back and forth.
- ⚠ While releasing other screws in the next steps, make sure to check each screw is still holding all the parts. If you release the screws above certain level, the entire body will fall apart.

STEP 5 FS-cover and hotend fan disassembly

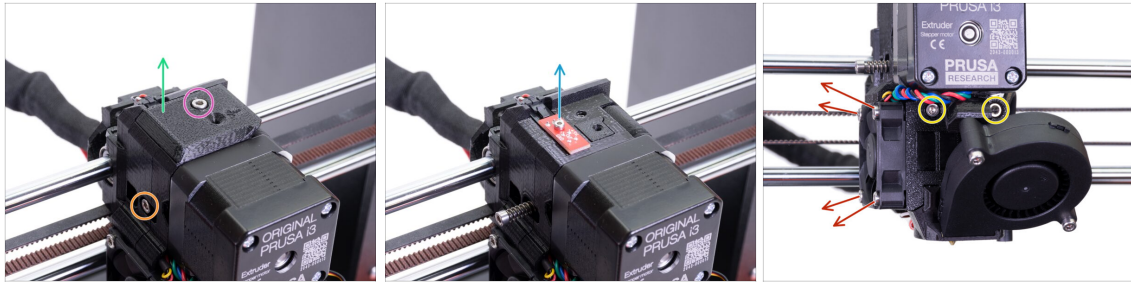

- ◆ Release the M3x10 screw and remove it.
- ◆ Remove the FS-cover it will be replaced with a new one.
- ◆ Release the screw holding the idler, you can leave it in the extruder.
- ◆ Release the M2x8 screw, carefully unplug and remove the IR filament sensor. **Keep it safe, you will need the sensor for the reassembly.**
- ⚠ **Be careful with the filament sensor, do not touch the components on the PCB. Hold the PCB by its sides.**
- ◆ Release both M3x40 screws, just few turns to create about 0.5cm (0.2inch) gap in the extruder body.
- ◆ Release and remove all screws holding the Hotend fan. We need to reach a screw behind the fan.

STEP 6 Extruder-body release

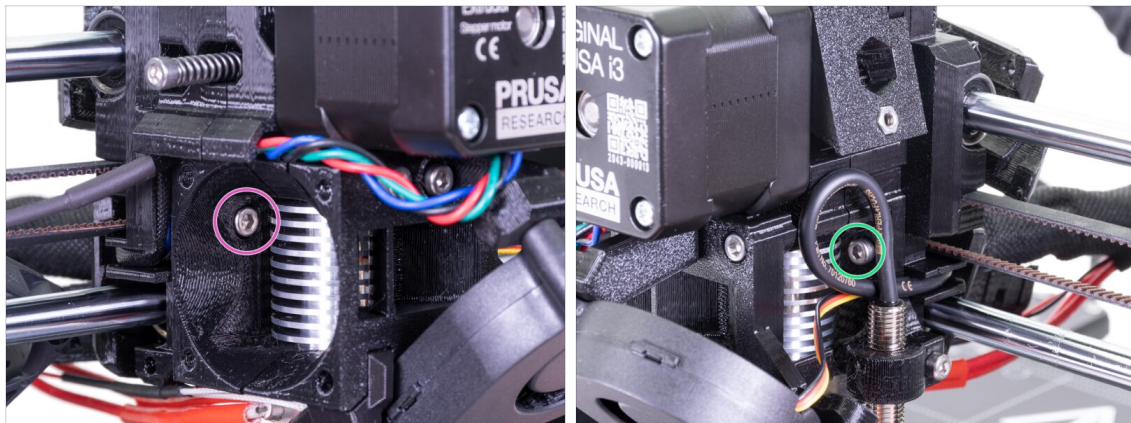

- ◆ Find a M3x10 hidden behind the fan and release it slightly, few turns are enough. Our goal is to keep the parts connected.
- ◆ Repeat the same procedure on the other side of the extruder.

STEP 7 Extruder-idler disassembly

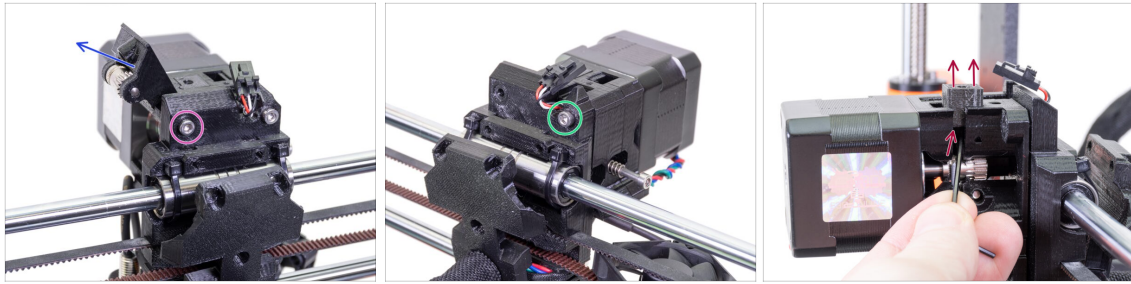

- ◆ Release and remove the M3x40 screw, the idler with the Bondtech gear will fall out.
 - ◆ Remove the Extruder-idler from the printer.
 - ◆ Release the other M3x40, but again just slightly to create a gap between the parts. We want to keep the entire extruder together.
 - ◆ Using the Allen key (2.5 mm) push the Adapter-printer part up. Keep in mind there is a steel ball inside.
- ⓘ We will replace Adapter-printer part and the steel ball with a new part.

STEP 8 Extruder-idler disassembly

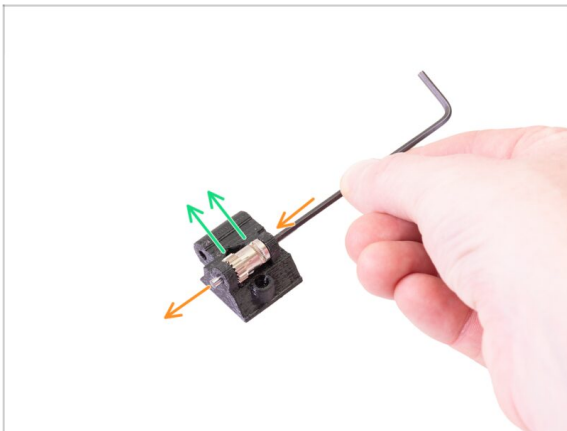

- ◆ Using the Allen key (2.5 mm) push and pull out the shaft. Keep it for later.
 - ◆ Take out the Bondtech gear, **BUT BE CAREFUL**, there are two bearings inside. Don't lose them!!!
- ⓘ The printed part will be replaced with a new one.

STEP 9 Haribo time?



- ◆ **Not yet!** Rewards are only for those who build a printer. Wait for the next chapter ;)

STEP 10 Testing, testing!

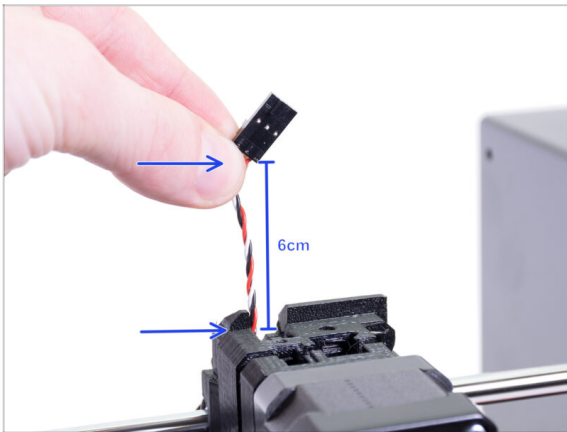

- ◆ Grab the wires of the IR filament sensor cable and gently pull up, the cable should slide without significant resistance.
- ◆ Does it move? Great the test is over for now ;)
- ⚠ **Don't pull hard! Ensure first that all screws are released properly.**
- ◆ Great! We are done here, let's move to the assembly chapter.

3. MK3S+ extruder upgrade



STEP 1 Extruder-body parts preparation

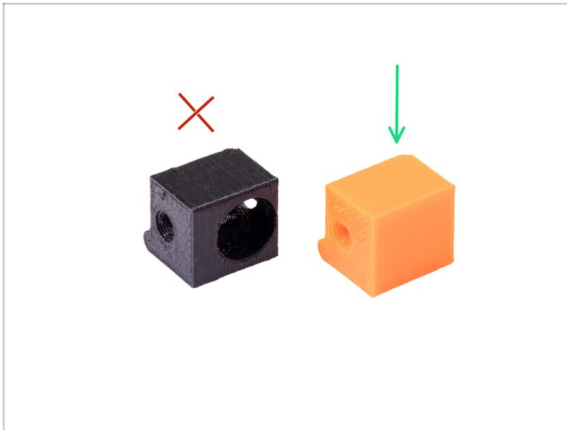

◆ For the following steps, please prepare:

◆ Adapter-printer-mmu2s

⚠ The package should include only the orange adapter. If you have printed parts yourself, **please don't use the version with the hole for steel ball.**

ⓘ There are two different orange Adapter-printer-mmu2s parts for **MK3S** and **MK3S+** included in the package. For **MK3S+**, pick the one seen in the picture.

STEP 2 Adapter-mmu2-assembly

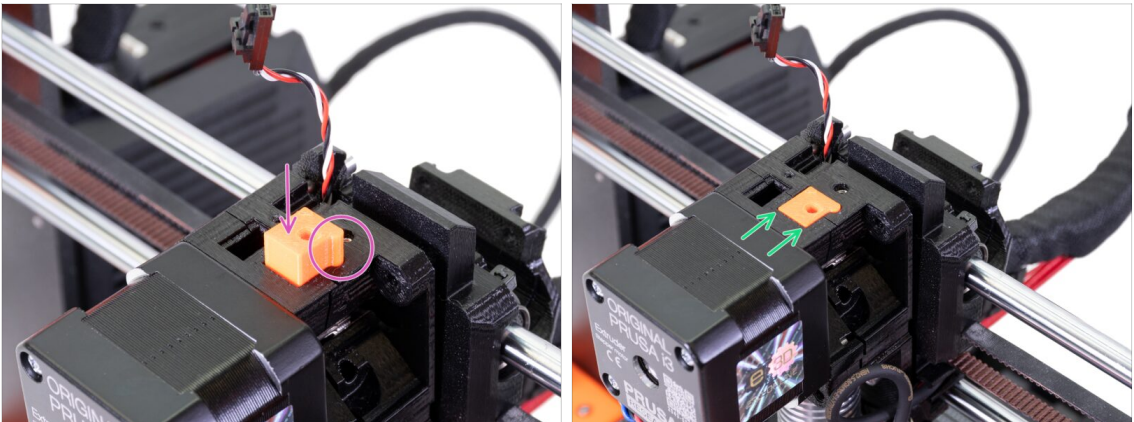

◆ Insert the Adapter-printer into the hole in the extruder-body. See the protrusion, it must fit into the groove.

◆ Push it down and check its upper surface is aligned with the extruder.

⚠ **DON'T** use any screw to secure the Adapter-printer-mmu2. It should hold inside the Extruder-body by itself.

ⓘ In case you have trouble inserting it because of the fs-lever part in the extruder body, move the fs-lever away using a 2mm Allen key while inserting the Adapter-printer.

STEP 3 IR filament sensor parts preparation

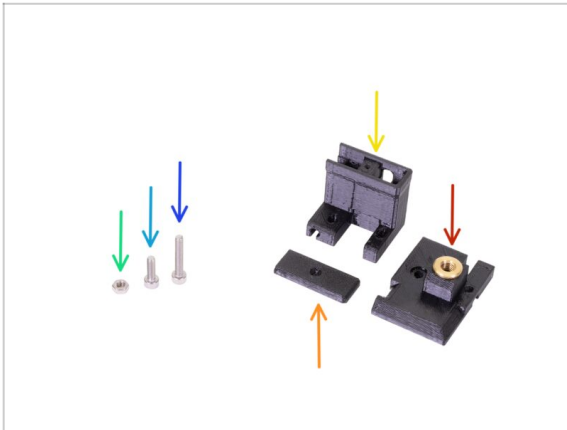

◆ For the following steps, please prepare:

- ◆ M3x18 screw (1x)
- ◆ M3x10 screw (1x)
- ◆ M3n nut (1x)
- ◆ FS-cover-mmu2s (1x)
- ◆ IR-sensor-holder-mmu2s (1x)
- ◆ IR-sensor-cover-mmu2s (1x)

📌 Look for these parts in MMU2S FASTENERS and MMU2S EXTRUDER bags.

⚠ The list continues in the next step...

STEP 4 IR filament sensor parts preparation

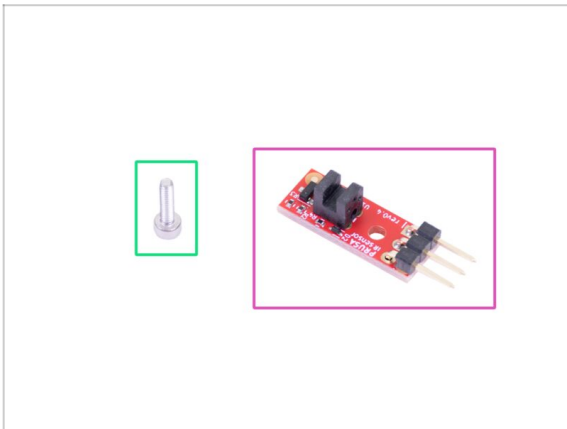

◆ For the following steps, please prepare:

- ◆ Prusa IR-sensor (1x)
- ◆ M2x8 screw (1x)

⚠ **Be careful with the filament sensor, do not touch the components on the PCB. Hold the PCB by its sides.**

ⓘ Following assembly should be done close to the extruder, no need to pull the IR-sensor cable out. However, for a better visibility of this guide, some parts of the assembly were done separately from the printer.

ⓘ MK3S+ and MMU2S share the same new generation of the IR filament sensor, just utilizing a different position in the extruder.

STEP 5 IR filament sensor assembly

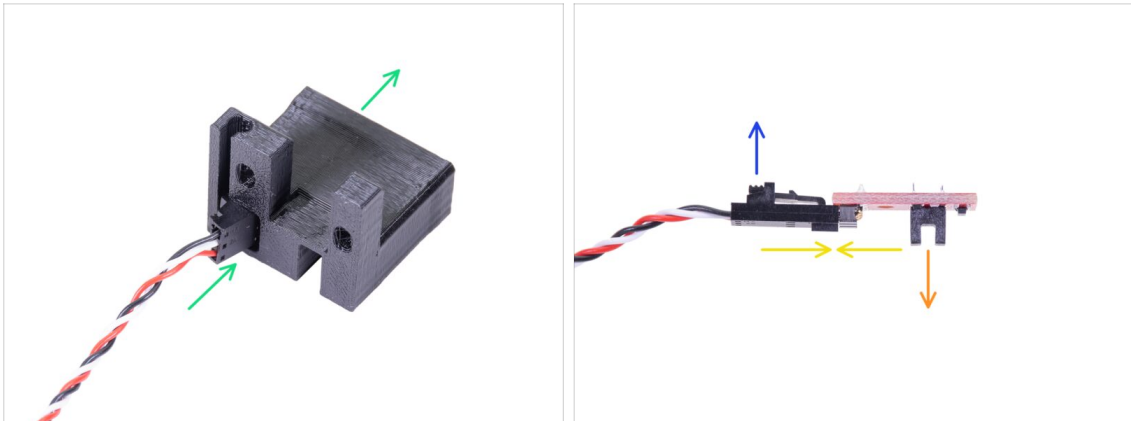

- ⚠ First, pull the IR-sensor cable up, so you have a slack for the assembly of the printed parts. At the same time watch the other end of the textile sleeve, if you pull the cable too much, the connector will disappear in the sleeve ;)
- 🟢 Take the smaller connector **WITHOUT THE SENSOR!** and carefully push it all the way through the IR-sensor-holder-mmu2s.
- 🟡 Once the connector is through, connect the cable and the sensor together.
 - 🟠 Make sure the safety latch is facing up.
 - 🟠 The sensor must be facing down.

STEP 6 IR filament sensor assembly

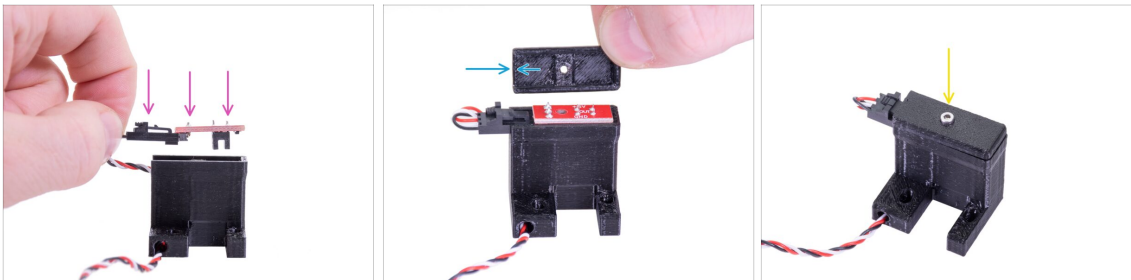

- 🟡 Take the IR filament sensor and place it in the holder, make sure the orientation is the same as in the picture.
- 🟠 Take cover and place it on the top. The cover is asymmetrical, see the picture. One side has no "frame" on the bottom side of the cover. Point this side to the connector.
- 🟡 Secure the IR filament sensor and the cover using the M2x8 screw you have removed from the extruder earlier.

STEP 7 IR filament sensor assembly



- Carefully insert the cable in the channel, make sure it is all the way in.
- Take the FS-cover-mm2s and push in the M3n nut.
- Slide the holder on the cover, again make sure it is all the way in, otherwise, the holes won't align properly.
- Secure both parts using an M3x10 screw, see the picture for the correct hole.
- ⓘ This entire IR filament sensor assembly is also called "chimney" in the Handbook.
- ⓘ Tip: If you can't reach the nut, try pulling it up using a longer fully threaded screw from the spare bag.

STEP 8 Mounting the IR filament sensor

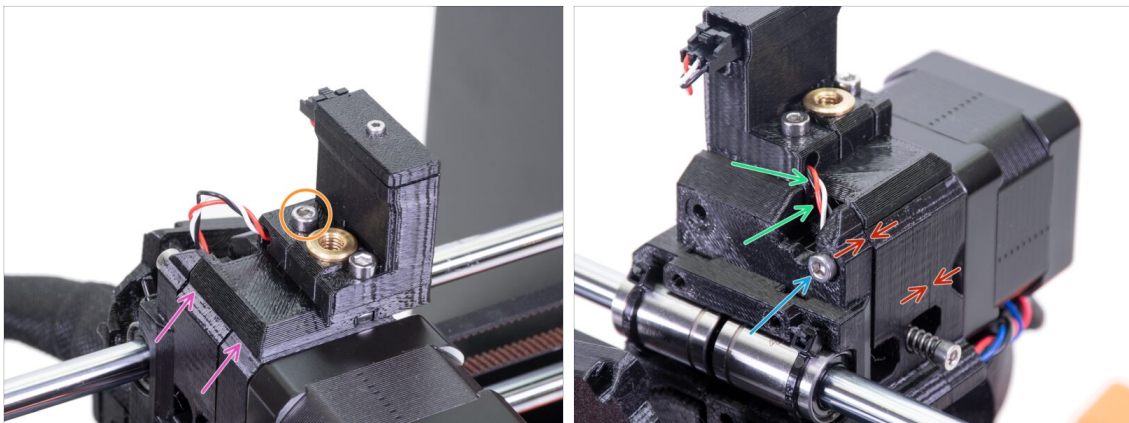

- Place the entire IR filament sensor assembly on top of the extruder.
- Align the left edge with the extruder body.
- Use a M3x18 screw to join both parts together.
- Carefully pull the cable down until the loop disappears completely. However, don't stretch the cable.
- Finish the sensor assembly by tightening the M3x40 screw.
- Make sure all the gaps are gone.
- ⚠ **The IR filament sensor position will be calibrated later in the upcoming chapter. Without the proper calibration, the MMU2S won't be able to work properly.**

STEP 9 X-carriage retightening

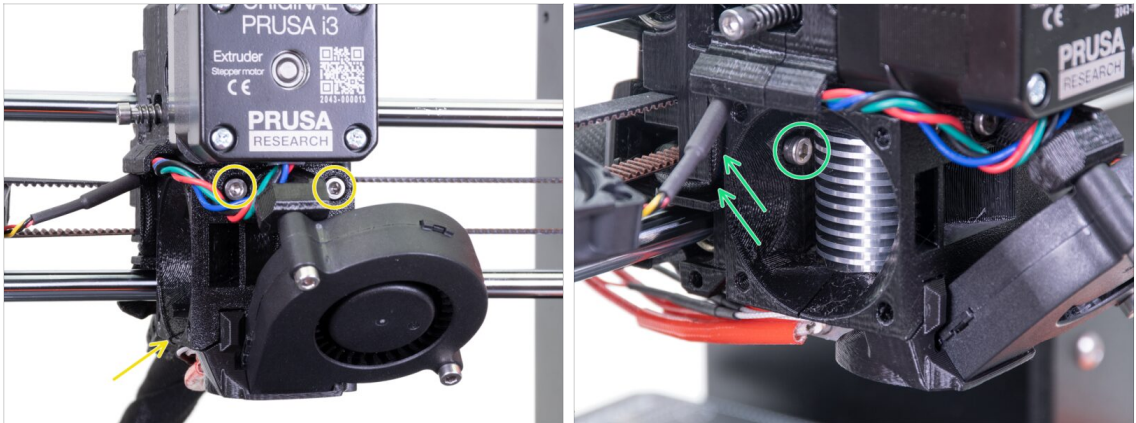

- Tighten both M3x40 screws, make sure the printed parts are aligned before tightening.
- Tighten both M3x10 screws between the Extruder-body and X-carriage. Before you do so, ensure no cable is pinched between both parts, there is a channel in the X-carriage for all the cables.

STEP 10 Hotend fan assembly

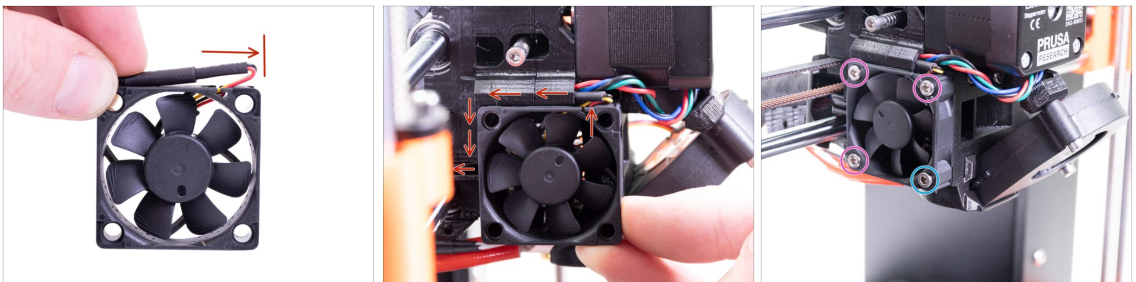

- ⚠ **The fan has two sides, one has a Noctua sticker. Make sure, this side is facing inside the extruder.**
- First, create a loop on the cable. Make sure the black protective wrap is close to the edge of the fan. See the picture.
- Slide the fan close to the X-carriage and **GENTLY PUSH** the cable in using an Allen key. Before you push the fan all the way to the left, place the cable in the X-carriage channel.
- Fix the fan using following screws (depending on the fan version):
 - M3x14 / M3x16b screw (3x)
 - M3x20 / M3x22b screw (1x)

STEP 11 Extruder-idler parts preparation



◆ **For the following steps, please prepare:**

- ◆ Extruder-idler-mm2s (1x)
- ◆ Bondtech gear (1x) *you have removed from the original idler before.*
- ◆ Bearing (2x) *might be stuck inside the gear*
- ◆ Shaft (1x)
- ◆ M3n nut (1x)
- ◆ M3x40 screw (2x)
- ◆ Idler spring (1x) *place the spring on the screw. The screw with the spring might be already in the extruder*

STEP 12 Bearing assembly



- ◆ **Insert both bearings** into the gear. Be aware that bearings can slip out during assembly.

STEP 13 Extruder-idler-mmu2s assembly

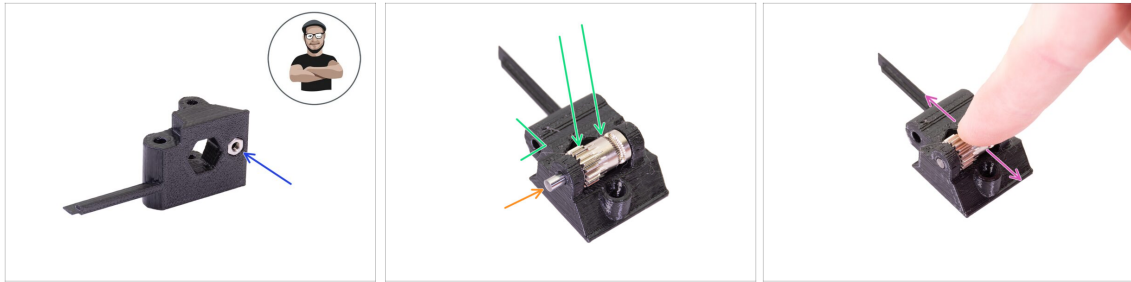

- ◆ Take M3n nut and place it in the Extruder-idler-mmu2s.
- ⓘ Use the screw pulling technique.
- ◆ Insert the Bondtech gear into the idler as shown in the picture. Make sure the geared part of the Bondtech is on the side of the plastic part with the cutout.
- ◆ Slide the shaft through the idler and pulley. Use reasonable force or you will **BREAK** the printed part.
- ◆ Place your finger on the bearing and ensure it can rotate freely.

STEP 14 Extruder-idler-mmu2s assembly

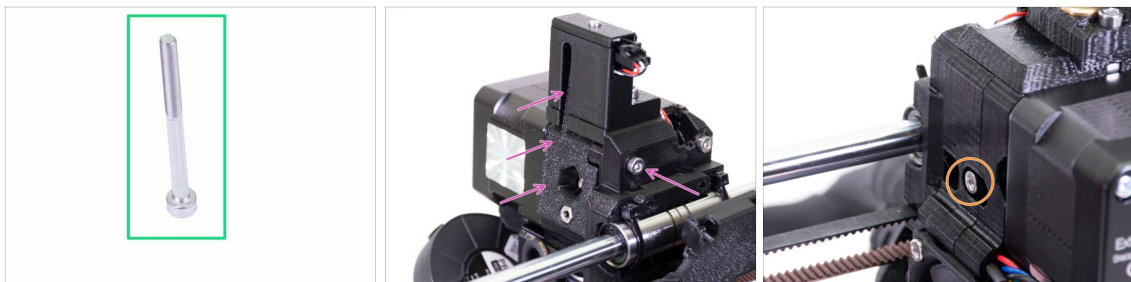

- ◆ **For this step, please prepare:**
- ◆ M3x40 screw (1x)
- ◆ Place the Extruder-idler-mmu2s in place and secure it using a M3x40 screw.
- ◆ Don't tighten the screw too firmly, it serves as a shaft for the idler. Check that the idler can rotate freely (the range of the movement is small).
- ◆ Use the M3x40 screw with the spring to introduce tension to the Extruder-idler.
- ⓘ Hold the Extruder-idler on the other side, until the screw reaches the nut. Since there is only one screw, you need to introduce a large force. The head of the screw, should be aligned or slightly below the surface.

STEP 15 X-carriage-back reassembly

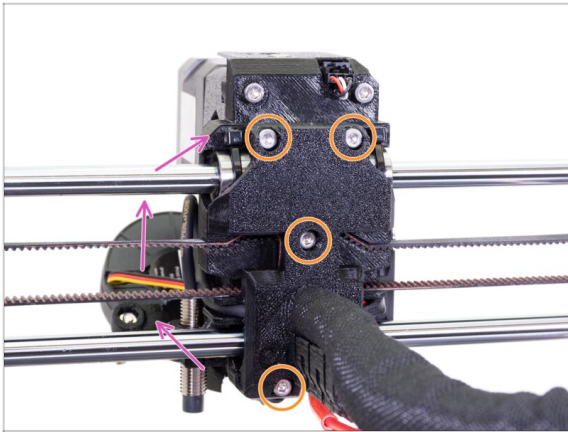

- ◆ Rotate the X-carriage-back back and push it gently towards the extruder. **Ensure no wires are pinched between both parts!!!**
- ◆ Tighten all four M3x10 screws.
- ⓘ Tighten the screws with a reasonable force, make sure you won't deform/squeeze the bearings between the printed parts.

STEP 16 Textile sleeve parts preparation

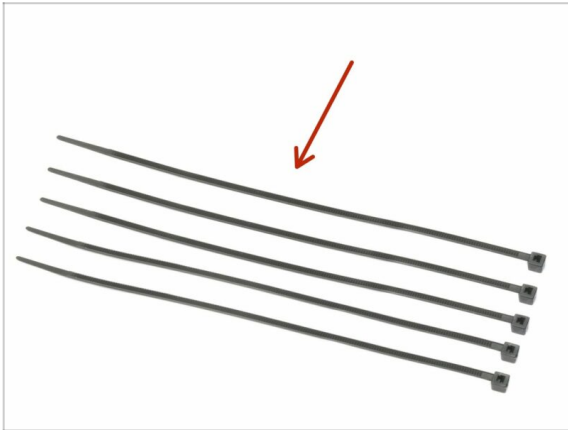

- ◆ For the following steps, please prepare:
- ◆ Zip tie (5x)

STEP 17 Tightening the textile sleeve

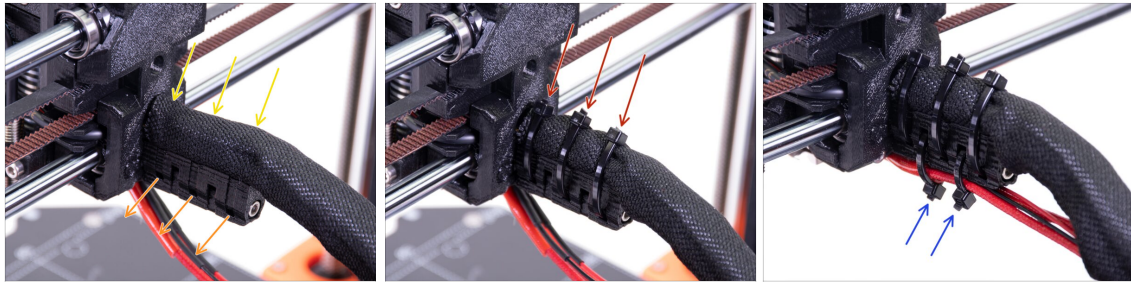

- ◆ Gently twist the sleeve to make it smaller and tighter around the cables and slide the sleeve towards the extruder.
- ◆ **Take 3 zip ties** and insert them into the **lower row** of holes on the cable-holder.
- ◆ Twist the sleeve again (without twisting the cables inside) and tighten the zip ties.
- ⚠ **IMPORTANT:** Cut the remaining part of each zip tie using pliers as close to its head as possible. Note the correct position of each zip ties's head (slightly off-centre to the left).
- ◆ Use two zip ties and push them through the upper slots on the cable-holder. Add the cables from the hotend and use the channel in the printed part to arrange them properly. Tighten the zip ties, cut the remaining parts.

STEP 18 It's Haribo time!

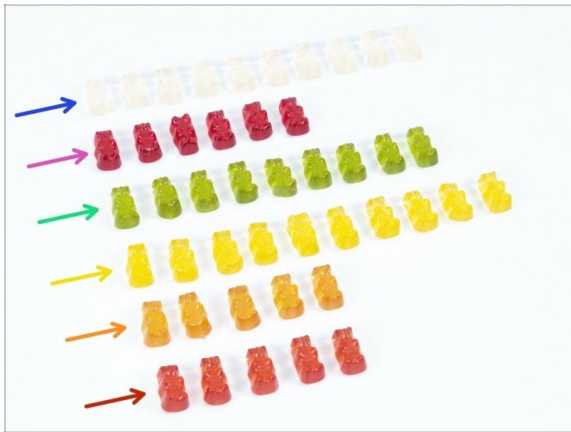

- ⚠ Carefully and quietly open the bag with the Haribo sweets. High level of noise might attract nearby predators!**
- Sort the bears into six rows according to the following scheme (colours might differ):
 - **Previous and current chapter** were very difficult, at least **25 % of total amount is needed**.
 - **Idler assembly** is quite easy, **10 %** is enough.
 - **Pulley body assembly** requires your attention, eat no less than **20 %** of all bears.
 - **Electronics assembly** is the last chapter with high level of difficulty, consume **25 %**.
 - **Spool holders with the buffer** are easy to make, research shows that **10 %** is enough.
 - **Preflight check** is almost effortless. Experienced user will require no more than **10 %**.

STEP 19 E-axis is finished!

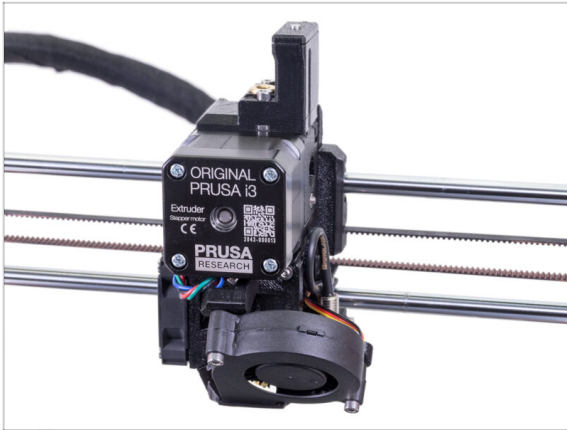

- ◆ **Are we there yet? We are just getting started!**
- ◆ Check the final look, compare it to the picture.
- ◆ Don't worry about the cable, we will connect it later ;)
- ◆ Checked everything? Let's move to the MMU2S unit assembly.

4. Idler body assembly



STEP 1 Tools necessary for this chapter

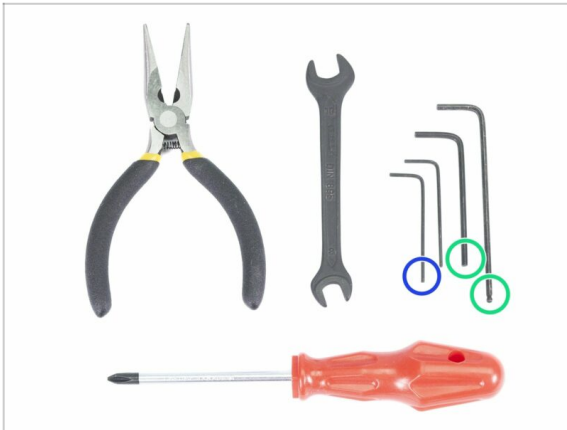

◆ **Please prepare tools for this chapter:**

◆ 2.5mm Allen key(s) for M3 screws

◆ 1.5mm Allen key for nut alignment

ⓘ Note there are two types of the 2.5mm Allen keys. Use the longer one for screws, which are difficult to reach as this Allen key has a ball end.

ⓘ You can use your own tools if you find them more suitable for the build.

STEP 2 Idler parts preparation



◆ **For the following steps, please prepare:**

◆ Idler (1x)

◆ 625 bearing (6x)

◆ M3x10 screw (2x)

◆ M3nS nut (2x)

◆ Shaft 5x16sh (5x)

ⓘ Note you need 6 bearings, but only 5 shafts ;)

STEP 3 Idler bearings assembly (part 1)

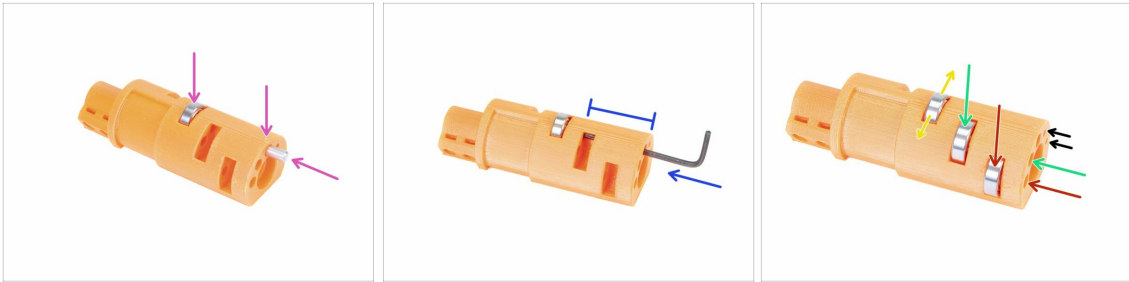

⚠ WARNING: read the instructions carefully, you have to **assemble bearings in the correct order**, otherwise you will encounter problems later!

- Take the first bearing and place it in the middle of the idler. Insert the shaft as in the picture, make sure you are using the opening on the top.
- Slide the shaft in using 2.5 mm Allen key. **Make sure the shaft is all the way in** and not blocking other slots for bearings.
- Take the second bearing with the shaft and assemble it in the same way as the previous one.
- Take the third bearing with the shaft and place it in the idler.
- Make final a check, ensure all three bearings can rotate freely.
- There are small openings on both sides of the idler, which can be used to push the shaft back.

STEP 4 Idler bearings assembly (part 2)

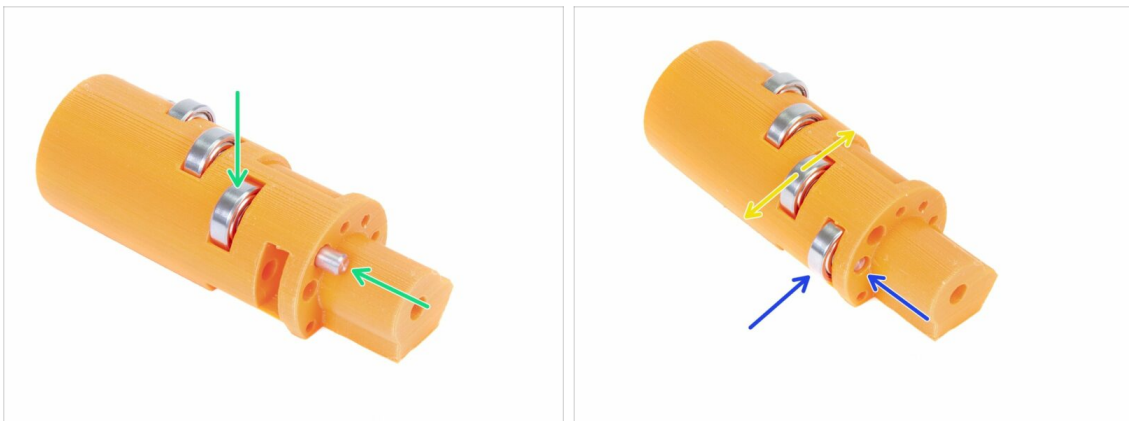

- Turn the idler around and continue with the bearing assembly.
- Start with the slot closest to the centre of the idler.
- Finish bearing assembly with the slot on the right side.
- Make final a check, ensure both bearings can rotate freely. *There should be no increased friction, or bumps, which would slow down the bearing.*

STEP 5 Idler nuts assembly

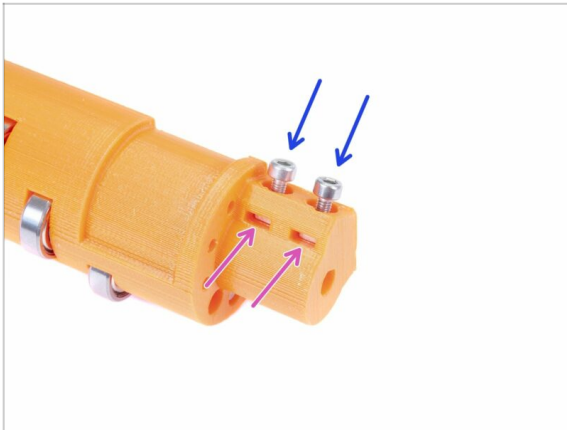

- ◆ Take two M3nS nuts and slide them in the idler all the way in.
- ⓘ Ensure proper alignment using a 1.5 mm Allen key.
- ◆ Grab two M3x10 screws and screw them slightly in the idler, just to catch the nuts. Five or six turns are enough for now.

STEP 6 Idler centre bearing assembly

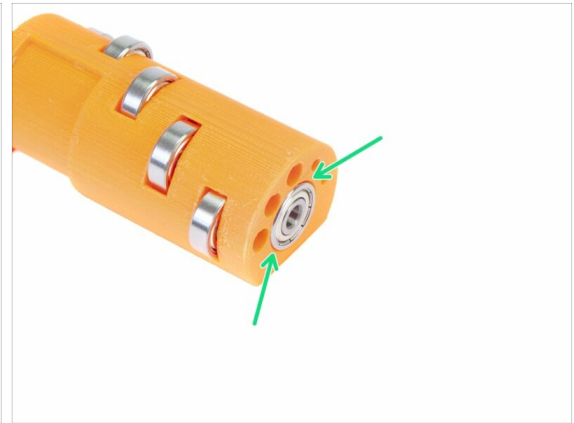

- ◆ Take the remaining bearing and slide it in the centre of the idler.
- ◆ Make sure the bearing is flush (aligned) with the idler surface.

STEP 7 Final check

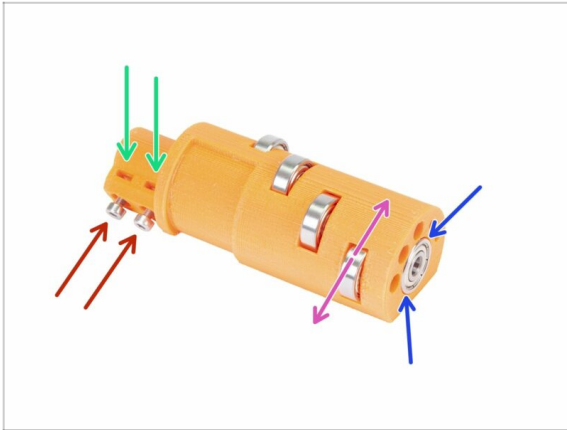

- **Before proceeding, check following:**
- ◆ All five bearings are able to rotate freely.
- ◆ The sixth bearing is aligned with the surface of the printed part.
- ◆ Both nuts are inserted.
- ◆ Screws are just slightly tightened.
- ⓘ Keep the idler close, we will need it soon.

STEP 8 Idler-body parts preparation



- **For the following steps, please prepare:**
- ◆ mmu2-idler-body (1x)
- ◆ M3x10 screw (5x)
- ◆ M3nS nut (2x)
- ◆ Shaft 5x16sh (1x)
- ◆ Idler motor (the one with a short shaft) (1x)
- ⓘ *In case of the MMU1 to MMU2S upgrade - use the motor from the disassembled MMU1. This motor was not included in the MMU1-MMU2S upgrade package. The motor is labeled "Extruder" instead of "Idler".*

STEP 9 Inserting M3nS nuts into idler-body

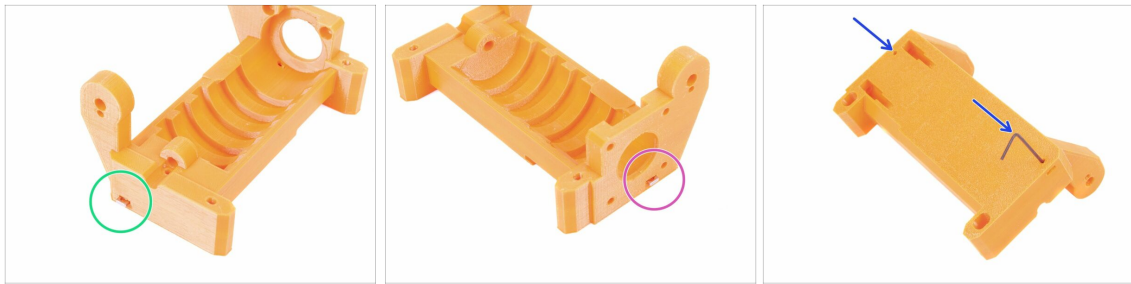

- Take the M3nS nut and insert in the slot of the idler-body, all the way in.
- Turn the idler-body to the other side, take the second M3nS nut and insert in the slot, all the way in.
- Ensure proper alignment of both nuts using 1.5mm Allen key.

STEP 10 Inserting the idler in the idler-body



- Slide the idler into the idler-body. Mind the correct orientation of the M3x10 screws.
- Push the idler down.
- Using fingers, rotate the idler back and forth to ensure the bearings can slide along the grooves easily. Some friction (rubbing) between the parts is acceptable at this stage.
- Rotation of the idler is limited by the stop on the idler-body.

STEP 11 Idler motor assembly (part 1)



- Before we assemble the motor to the idler-body, we need to rotate the shaft properly.
- Check the idler opening, which **ISN'T ENTIRELY CIRCULAR!** There is a flat part, which matches the shape of the motor's shaft.
- Rotate the shaft as in the second picture. To match the opening in the idler.

STEP 12 Idler motor assembly (part 2)

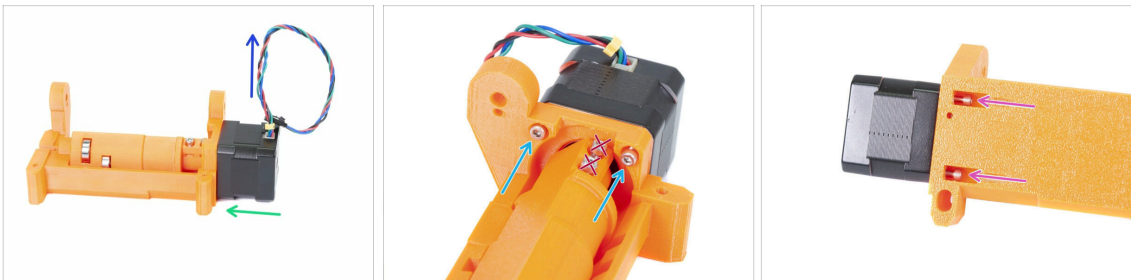

- Move the motor towards the idle-body. If necessary **ADJUST THE ROTATION OF THE SHAFT** to match the opening in the idler.
- Make sure the **CABLE** from the motor is **FACING UP**.
- Slide two screws M3x10 in the opening on idler-body and tighten them slightly.
- Turn the entire assembly upside-down and insert second couple of the M3x10 screws, again tighten them slightly.
- Make sure the motor is seated properly (in direct contact with the idler-body), then tighten all four screws. Tighten screws on a diagonal.
- ⓘ Use the longest 2.5mm Allen key with the ball end to reach the M3 screws on the underside better.

STEP 13 Idler motor assembly (part 3)

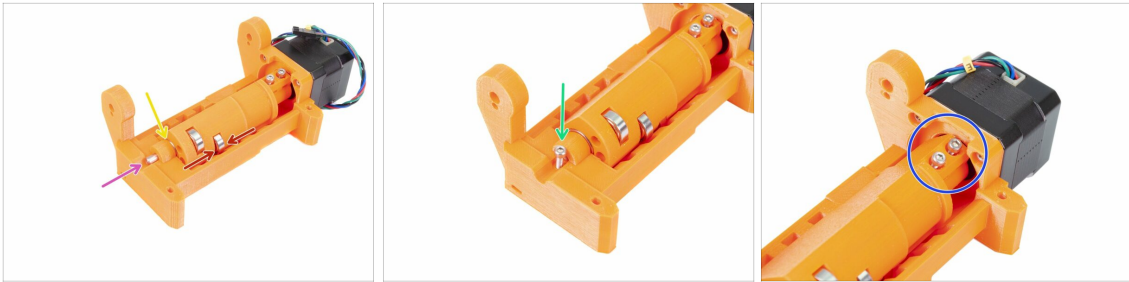

⚠ WARNING: read the instructions first! There is a risk of cracking the printed part!

- ◆ Insert the shaft 5x16sh into the idler-body and align it with the surface. Make sure the shaft reached the idler.
- ◆ Ensure the bearings are in the middle of the grooves in the idler-body and you can rotate the idler easily, if not slide the entire idler.
- ◆ Check there is a small gap between the idler (barrel) and the idler-body. In case the parts are grinding you might have issues with the filament loading!
- ◆ Screw in the M3x10 screw as a safety.
- ◆ Tighten both M3x10 screws until you reach the motor's shaft. **Tighten carefully, as you might crack the printed part (idler)!!!**

STEP 14 It's Haribo time!



- ◆ Stop for a while and treat yourself ;)
- ◆ Idler assembly is quite easy, 10 % is enough.

STEP 15 Final check

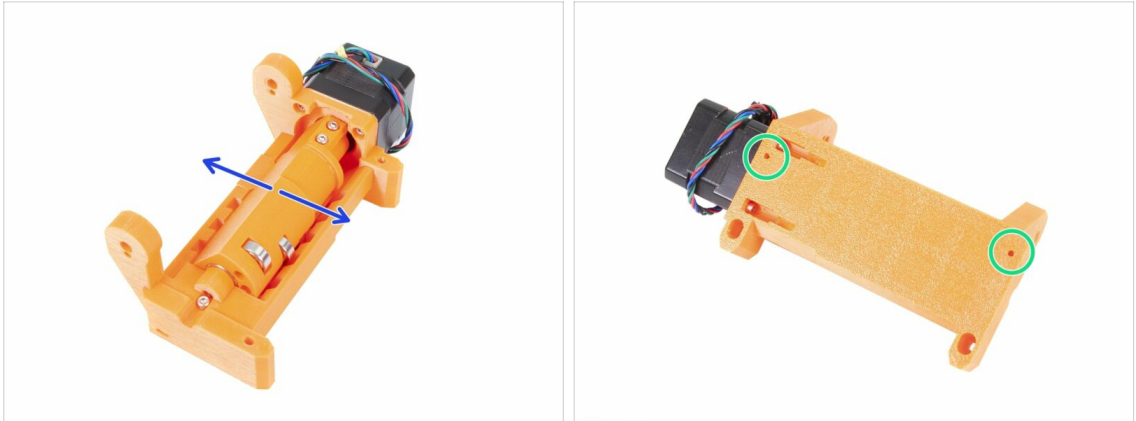

- ◆ Make sure the shaft rotates freely. The rotation is limited by stops, but within them it should be smooth.
- ◆ Make sure both M3nS nuts are in.
- ◆ Ready for more? Let's proceed to the [5. Pulley body assembly](#)

5. Pulley body assembly



STEP 1 Tools necessary for this chapter



- Please prepare tools for this chapter:
- 2.5mm Allen key for M3 screws
- 1.5mm Allen key for nut alignment
- Needle-nose pliers for blade assembly
- Measurement tool (optional), best is a digital caliper

STEP 2 Pulley-body parts preparation

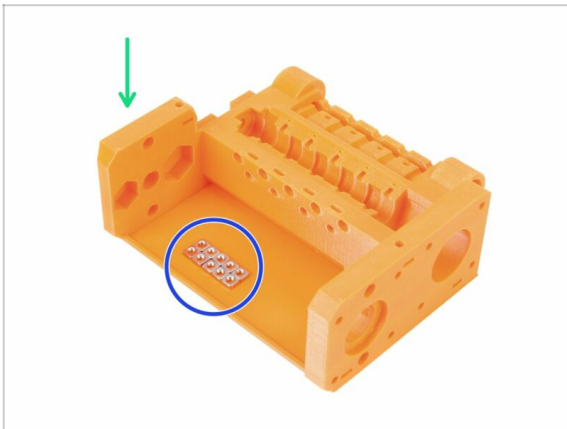

- For the following steps, please prepare:
- mmu2-pulley-body (1x)
- M3nS nut (10x)
- ⓘ Nuts are placed in the pulley-body just for the photograph, no need to arrange them like this ;)

STEP 3 Pulley-body assembly (part 1)

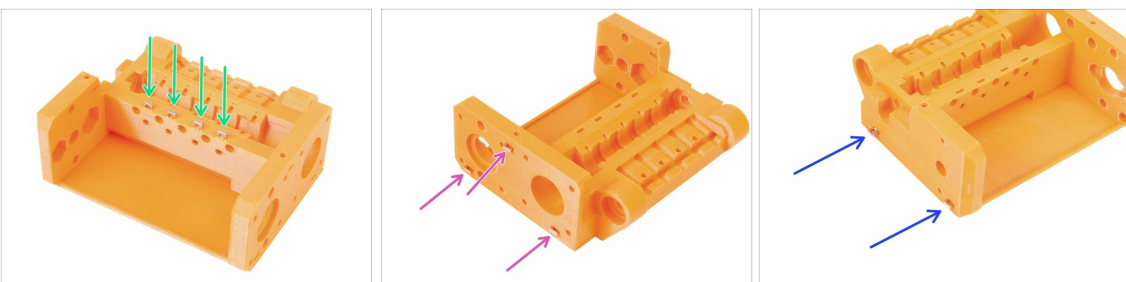

- Insert **four nuts** from the top of the pulley-body.
- Insert **three nuts** from the side of the pulley-body.
- Finally, insert **two nuts** from the other side of the pulley-body.
- Ensure proper alignment of all nuts using 1.5mm Allen key.

STEP 4 Pulley-body assembly (part 2)

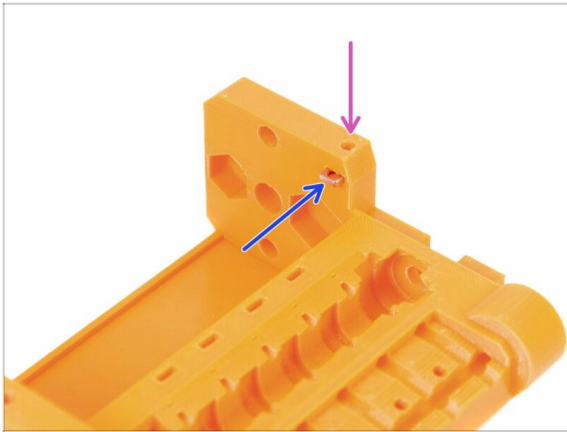

- ◆ Finally, insert the last (tenth) M3nS nut in the slot.
- ◆ Ensure proper alignment of nut using 1.5mm Allen key.

STEP 5 Pulley motor parts preparation

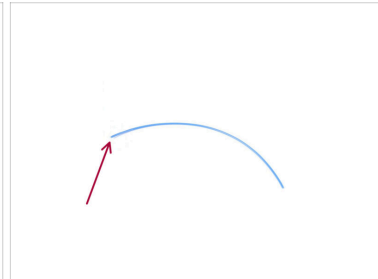

◆ For the following steps, please prepare:

- ◆ Pulley (5x)
- ◆ M3x10 screw (4x)
- ◆ 625 bearing (1x)
- ◆ Pulley motor (1x)
- ◆ Filament with length 10-15 cm (1x)
- ⓘ The filament is not part of the upgrade kit, use any 1.75mm you have. Use a straight filament if possible.
- ⓘ The pulley motor is not included in the MMU1 to MMU2S upgrade kit, see the next step.

STEP 6 MMU1 to MMU2S upgrade (part 1)

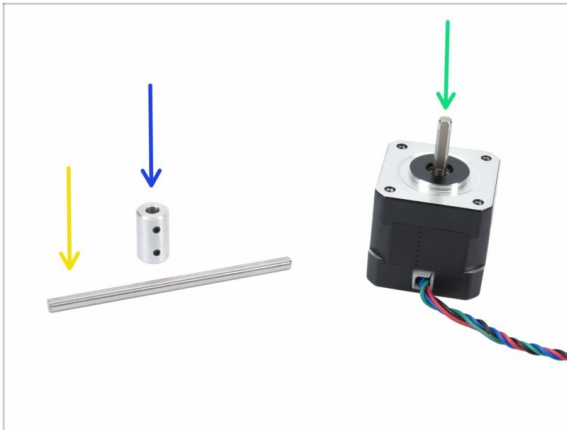

⚠ This step is valid only for those who are upgrading from MMU1 to MMU2S. Everyone else should skip to the Step 9

⬢ For the following steps, please prepare:

⬢ Shaft coupler (1x)

⬢ Shaft 5h9x90 (1x)

⬢ Extruder motor (1x)

i Use the motor from the disassembled MMU1. This motor is not included in the MMU1-MMU2S upgrade package

STEP 7 MMU1 to MMU2S upgrade (part 2)

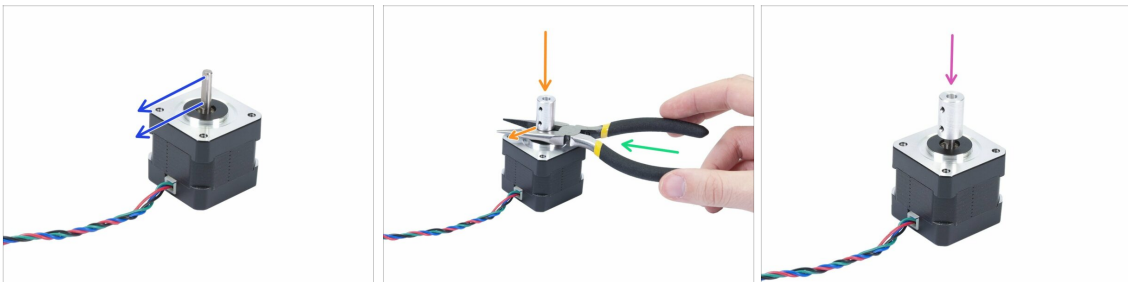

⚠ This step is valid only for those, who are upgrading from MMU1 to MMU2S.

- ⬢** Rotate the flat part of the shaft in the direction of the cable.
- ⬢** Insert bundled pliers to create a gap between the motor and the shaft coupler. If you want to be precise, the gap should be 10 mm.
- ⬢** Place the shaft coupler on the top of pliers and rotate the lock screw against the flat part of the shaft. Tighten the lower screw.
- ⬢** Slightly press on the shaft coupler from the top to ensure the lower lock screw is engaged.

STEP 8 MMU1 to MMU2S upgrade (part 3)

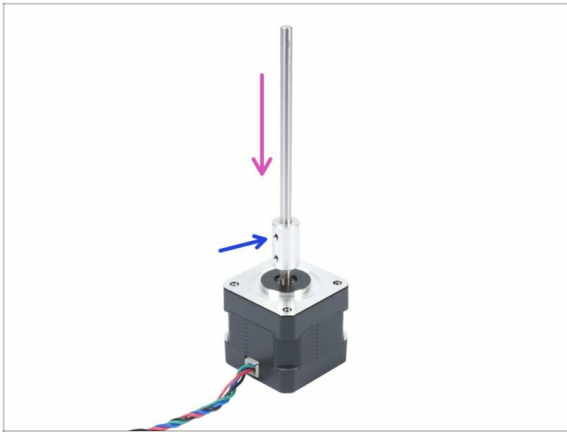

⚠ This step is valid only for those, who are upgrading from MMU1 to MMU2S.

◆ Insert the shaft into the shaft coupler and rotate the flat part against the lock screw.

◆ Tighten the lock screw.

i Even though this motor is labelled "Extruder" consider it "Pulley motor" from now on.

STEP 9 Pulley motor assembly (part 1)

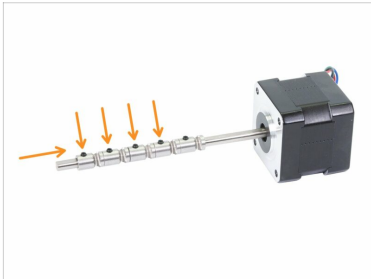
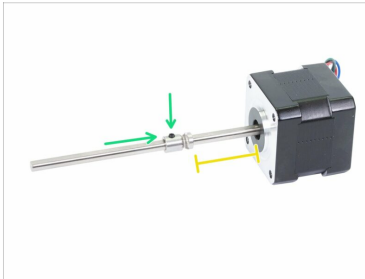
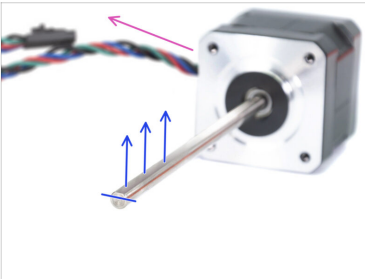

◆ First, make sure the motor cable is facing to the left.

◆ Find the flat part of the shaft and rotate it up.

◆ Slide the first pulley on the shaft, ensure the lock screw is on the top (against the flat part of the shaft). Tighten the lock screw just slightly.

◆ The first pulley should be around 30 mm (1.18 inch) from the black "ring" on the motor. Don't tighten the lock screw, you will need to adjust the position later.

◆ Slide the other pulleys in the same orientation (lock screw facing up). Tighten the lock screw on each just slightly.

i Exact position of each pulley will be adjusted later.

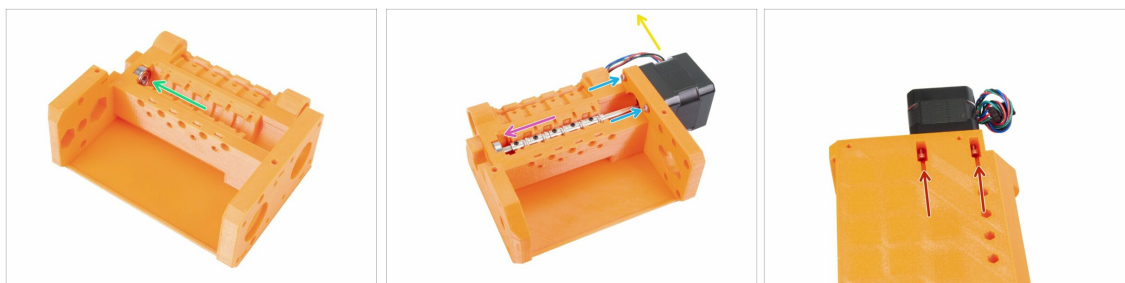
STEP 10 Pulley motor assembly (part 2)

- Insert the 625 bearing in the pulley-body. At the end the bearing should "snap" to the opening in the printed part.
- Slide in the Pulley motor, the shaft must enter the bearing.
- Cable of the motor should be oriented to the left, see the second photo.
- Slide two screws M3x10 in the opening on idler-body and tighten them slightly.
- Turn the entire assembly upside-down and insert second couple of the M3x10 screws, again tighten them slightly.
- Make sure the motor is seated properly (in direct contact with the pulley-body), then tighten all four screws. Tighten screws in a diagonal pattern.

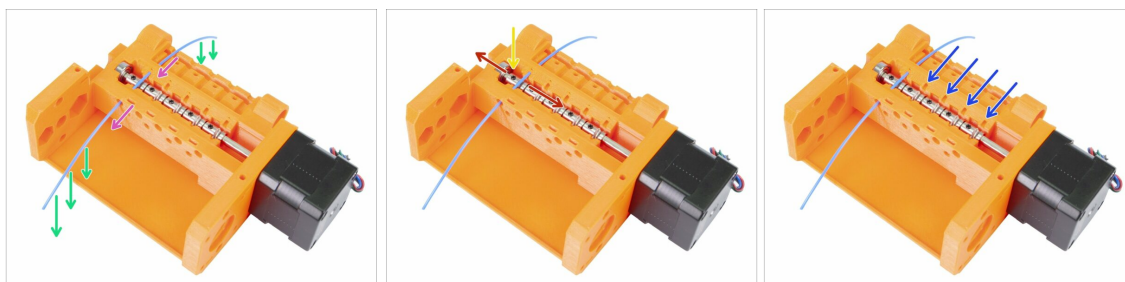
STEP 11 Pulley adjustment

- ⚠ **WARNING:** this step is crucial for proper functioning of the Multi Material Upgrade. Please check your alignment multiple times!!!
- Push the filament through the pulley body as in the picture.
- In case your filament is bent, make sure the bend points down, so the part above the pulley is straight.
- Adjust the position of the pulley, the teeth must be directly below the filament.
- ⚠ Check again the proper position relative to the teeth on the pulley.
- Make sure the lock screw is still perpendicular to the flat part of the shaft and tighten it. Use reasonable force as you might strip the screw.
- Repeat these instructions on the 4 remaining pulleys.

STEP 12 Front-PTFE-holder parts preparation

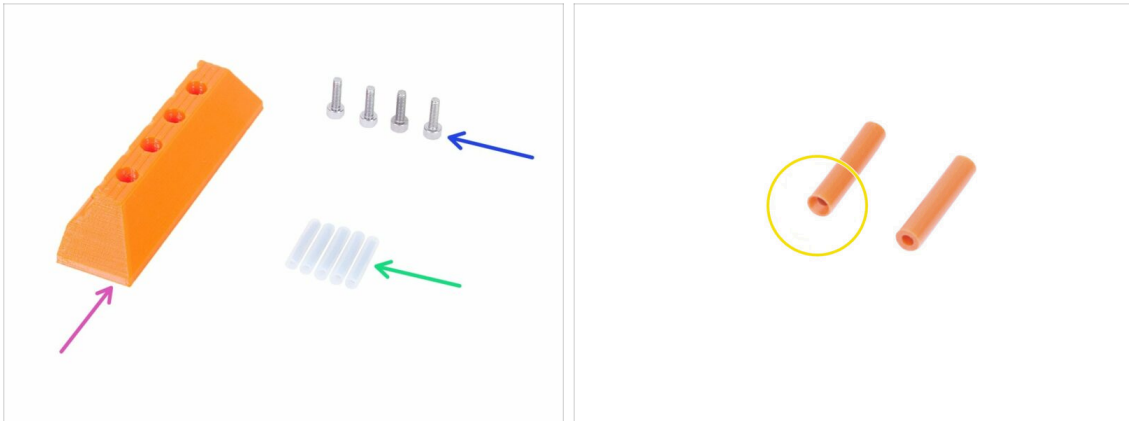

◆ **For the following steps, please prepare:**

◆ mmu2-front-PTFE-holder (1x)

◆ M3x10 screw (4x)

◆ PTFE 4x2x19 (5x)

◆ Note the PTFE tube has one end chamfered, please pay attention to the instructions about proper orientation.

ⓘ The PTFE tubes can be also in white color, other parameters are same as the orange version.

STEP 13 Front-PTFE-holder assembly

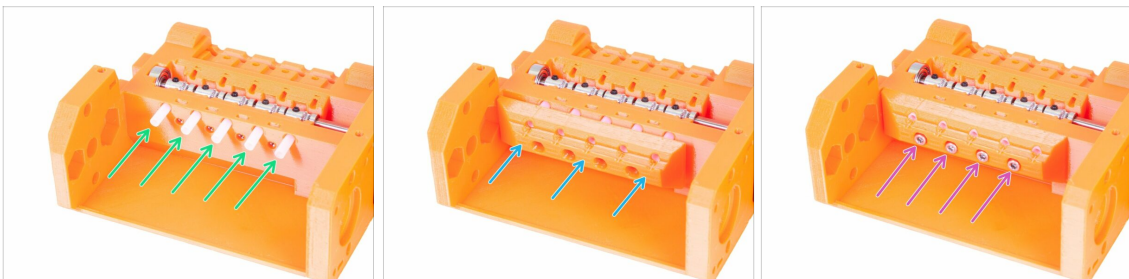

◆ Insert the PTFE tubes in the pulley-body all the way in. Approximately half of their length should stick out. **The chamfered end of the tube must be facing out!!!!**

◆ Slide on the front-PTFE-holder, note the upper circular openings are for the tubes.

◆ Secure the front-PTFE-holder using four M3x10 screws.

STEP 14 Selector-finda parts preparation

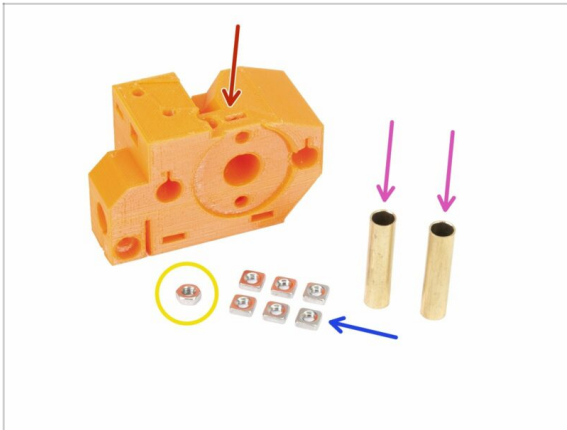

◆ For the following steps, please prepare:

- ◆ mmu2-selector-finda (1x)
- ◆ M3nS nut (6x)
- ◆ M3n nut (1x)
- ◆ Tube 5x6x25bt (2x)

STEP 15 Selector-finda assembly (part 1)

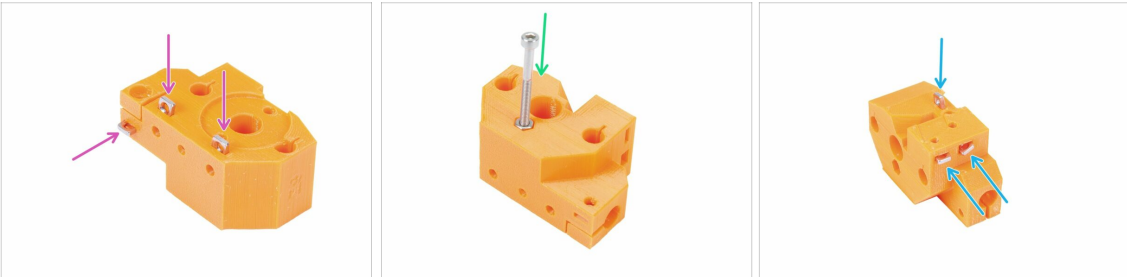

- ◆ Insert three M3nS nuts in the selector-finda body, all the way in. Ensure alignment with the 1.5mm Allen key.
- ◆ Slide in the M3n nut. If possible use long screw from the "Spare" bag or from your MK3 kit. Press the nut in using hand, hammer shouldn't be necessary.
- ◆ Insert remaining three M3nS nuts in the selector-finda body, all the way in. Ensure alignment with the 1.5mm Allen key.

STEP 16 Selector-finda assembly (part 2)

- ◆ Rotate the selector-finda as in the picture. Holes for the tubes are bigger from this side.
- ◆ Insert the tubes all the way in. Both should be aligned with the surface of the printed part.
- ⓘ In case you can't push the tubes in, try first rotating the tube while pushing down. Then turn the printed part and use a flat surface to push the tubes in evenly. Avoid using hammer as you can damage the tube's rim!

STEP 17 Selector motor parts preparation

- ◆ **For the following steps, please prepare:**
- ◆ mmu2-selector-front-plate (1x)
- ◆ M3x10 screw (7x)
- ◆ Smooth rod 5x120sh 120 mm (2x)
- ◆ Selector motor (1x)
- ◆ Lead screw nut (1x)
- ⓘ The nut is on the motor, take it off the lead screw.

STEP 18 Nut assembly



- Rotate the selector-finda as in the picture. There is a cut out for the nut.
- Place the nut on the selector-finda part, it should fit in the cut out.
- Secure the nut with two M3x10 screws.
- ⓘ There are four holes in the nut, you can use any of them, they are the same.
- ⓘ Tip: if you can't reach the M3n nut, use a M3x18 screw from the spare bag and by tightening it, pull the nut closer.

STEP 19 Selector-front-plate assembly

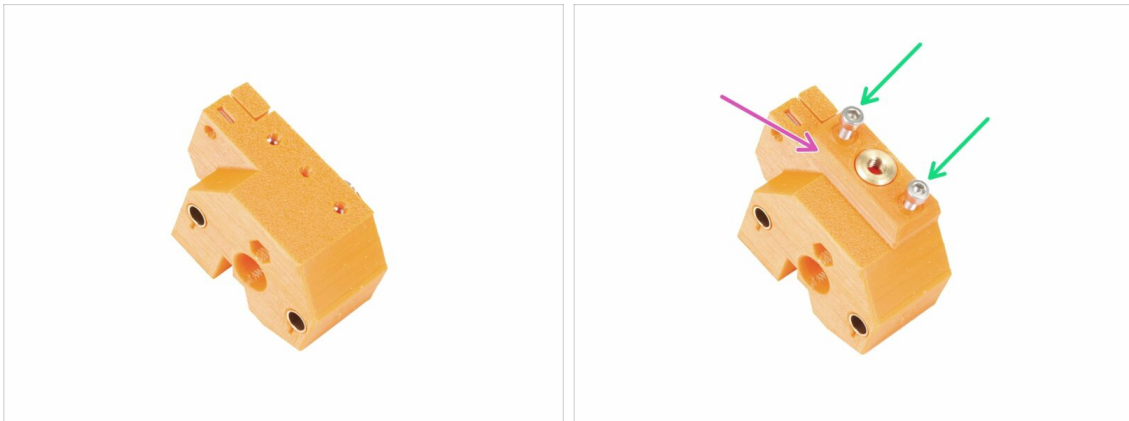

- Rotate the selector-finda as in the picture.
- Place the selector-front-plate as in the picture. Note, there is a flat and angled edge on this printed part. The angled edge should point toward the centre of the selector-finda body.
- Secure it with two M3x10 screws.
- ⓘ In the next step we will assemble the blade, but keep the parts you have prepared at step 17, we will use them soon.

STEP 20 Blade-holder parts preparation

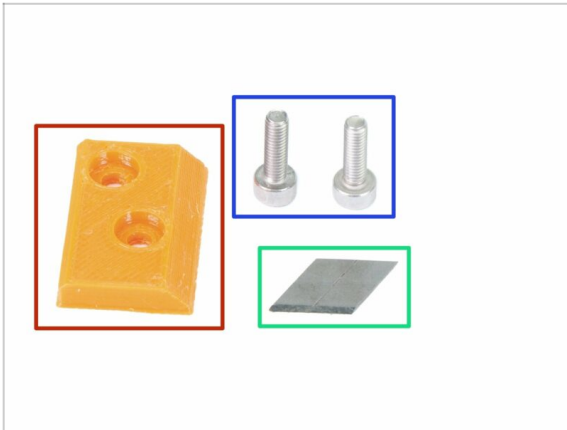

!!! WARNING: in this and following steps you will be assembling the blade. **Make sure you don't cut yourself.** Use pliers or gloves to protect your fingers !!!

For the following steps, please prepare:

mmu2-blade-holder (1x)

M3x10 screw (2x)

blade (1x)

There are two blades in the kit, the other one is a spare.

STEP 21 Blade-holder assembly



Prepare the selector-finda part as in the picture.

Carefully place the blade in the prepared cutout and align it with the top left corner.

Make sure the sharp part of the blade is pointing in the indicated direction.

Note that the blade-holder printed part has protrusion in the shape of the blade, place it on the top of the blade and make sure that both parts are properly aligned.

Place the blade-holder on the top of the blade and secure it with two M3x10 screws. Before you tighten the screws fully, ensure the blade is seated properly. Gently push it with the Allen key.

From now on pay attention while handling this part. The blade sticks out and you can cut yourself!

STEP 22 Selector motor assembly (part 1)

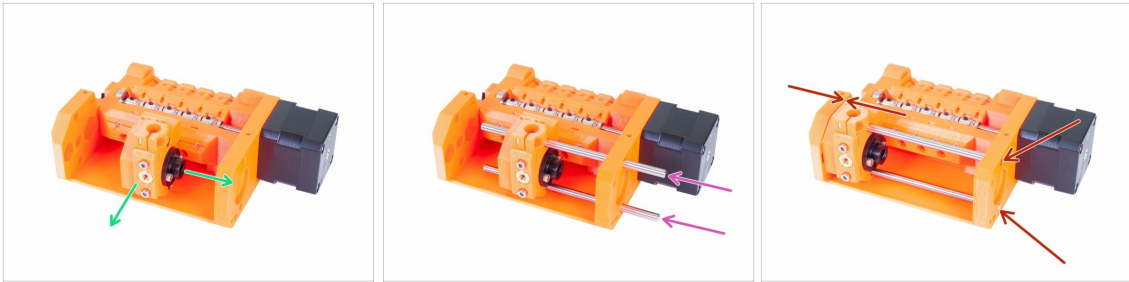

- Before assembling the motor we need to assemble the selector-finda part.
- Place the selector-finda part as in the picture. The correct orientation is important but the exact position doesn't matter now.
- Insert both shafts through the pulley-body and the selector-finda part.
- Make sure both shafts reached the end of the pulley-body. There are two circular holes for them.
- Ensure the shafts are aligned with the pulley-body and move the selector-finda all the way to the left.
- **FINAL CHECK:** move the selector back and forth along the entire length of the smooth rods to ensure the blade isn't colliding with the other printed parts.

STEP 23 Selector motor assembly (part 2)

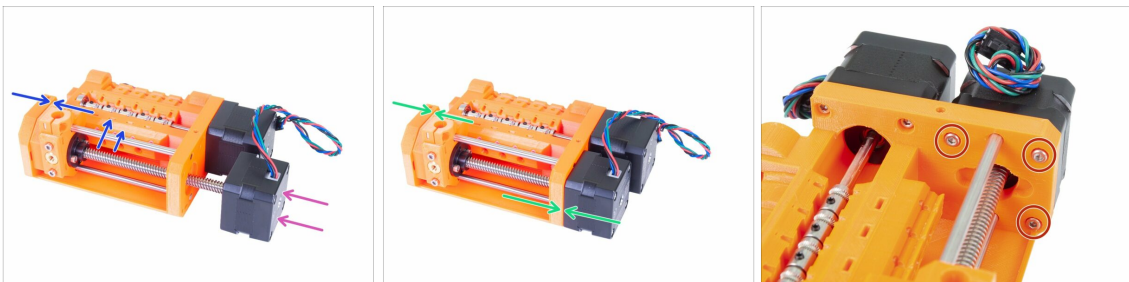

- Slide the Selector motor in, make sure the cable points up.
- ⚠ Check the thread on the shaft and ensure there is no piece of plastic in it. Otherwise, you might have issues with the assembly.
- As soon as you reach the thread of the nut, hold the selector-finda and start rotating the shaft clock wise.
- Rotate with the shaft until the motor touches the pulley body. Make sure the selector-finda is all the way to the left.
- Secure the Selector motor using three M3x10 screws.

STEP 24 SuperFINDA sensor parts preparation

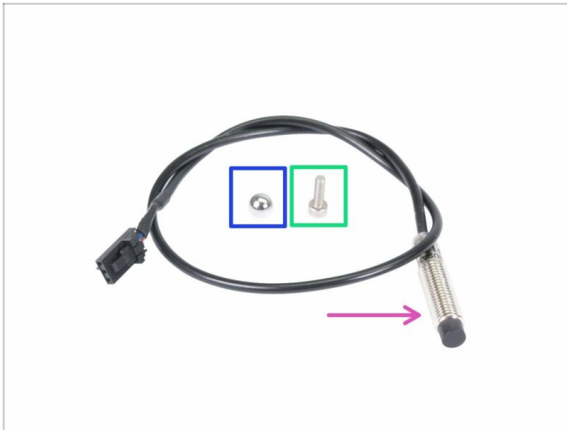

⚠ Though the design is similar, please note there is **P.I.N.D.A. or SuperPINDA probe** used in the extruder on a regular Original Prusa i3 printer and **F.I.N.D.A. or SuperFINDA sensor**, which has a shorter cable and is used only in the MMU unit.

⬛ For the following steps, please prepare:

- ◆ SuperFINDA sensor (1x)
- ◆ F.I.N.D.A. ball (1x)
- ◆ M3x10 screw (1x)
- ⓘ Extra ball is in the spare package ;)

STEP 25 SuperFINDA sensor assembly

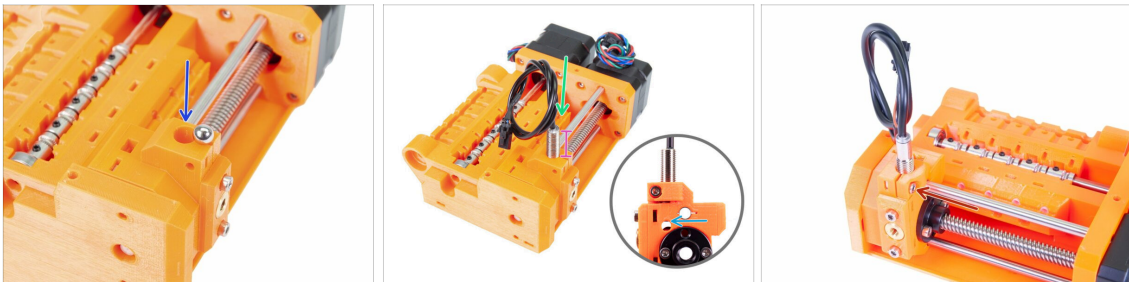

- ◆ Push the ball in the selector-finda circular opening.
- ◆ Carefully screw in the SuperFINDA sensor. We recommend wrapping the cable as in the picture to avoid damaging it.
- ◆ The exact position of the SuperFINDA sensor will be calibrated in the upcoming chapter. For now, let about 15 mm (0.6 inch) of the metal part above the printed part.
- ◆ **The newest MMU2S unit revision** has inspection windows on the sides of the selector. It is a good starting point to line up the bottom of the SuperFINDA probe exactly with the top of the inspection window when looking from the selector motor side.
- ◆ Insert M3x10 screw as in the picture, tighten it very slightly.

STEP 26 MMU2S unit parts preparation

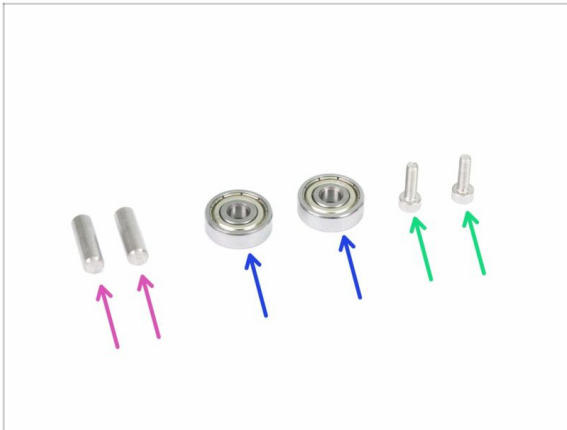

◆ For the following steps, please prepare:

◆ Shaft 5x16sh (2x)

◆ 625 bearing (2x)

◆ M3x10 screw (2x)

ⓘ The MMU2 unit is considered as the set of all the printed parts, motors, shafts, etc. assembled together.

STEP 27 MMU2S unit assembly (part 1)

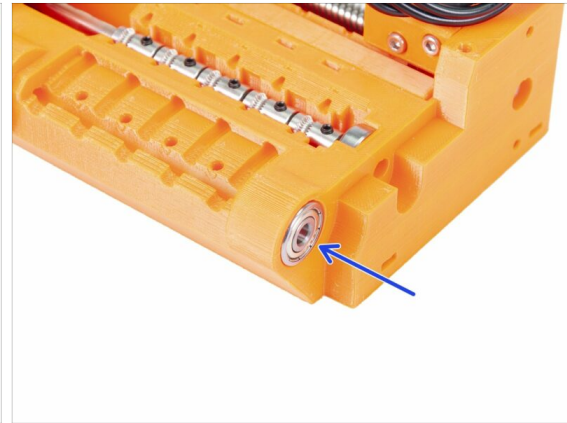
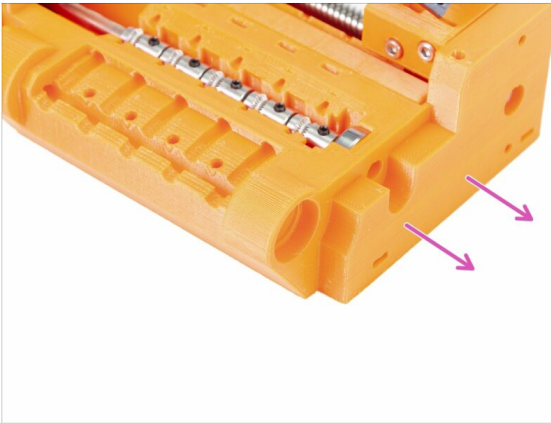

◆ Turn the pulley-body side without motors towards you.

◆ Push the bearing in. Make sure it is aligned with the pulley-body.

ⓘ If the bearing can't be pushed in easily, check the circular opening in the pulley-body and clean up any print imperfections if necessary.

STEP 28 MMU2S unit assembly (part 2)

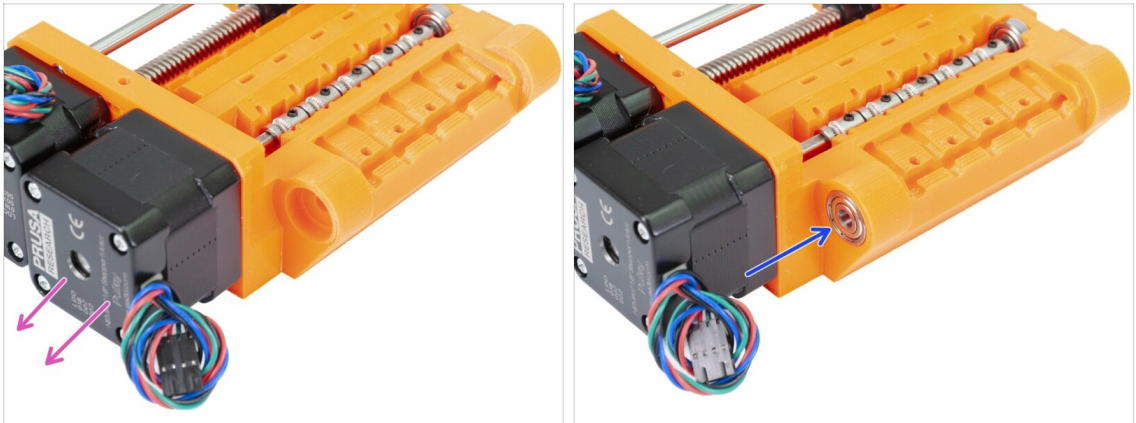

- ◆ Turn the pulley-body side with motors towards you.
- ◆ Push the bearing in. Make sure it is aligned with the pulley-body.

STEP 29 MMU2S unit assembly (part 3)



- ◆ Let's assemble the MMU2S unit ;)
- ◆ Prepare the pulley-body and idler-body as in the picture. Note position of the motors.
- ◆ "Rotate" the idler-body on the pulley body.
- ◆ Proper alignment will be done in the next step.

STEP 30 MMU2S unit assembly (part 4)

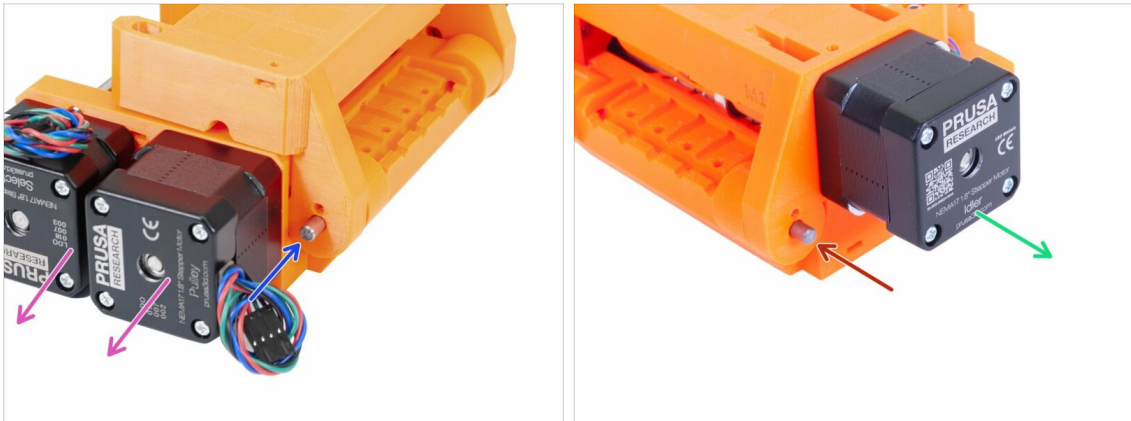

- ◆ Turn the side with two motors towards you.
- ◆ Slide in the shaft 5x16sh, align it with the outer surface.
- ◆ Turn the side with one motor towards you.
- ◆ Slide in the second shaft 5x16sh, align it with the outer surface.

STEP 31 MMU2S unit assembly (part 5)



- ◆ Turn the side with two motors towards you.
- ◆ Use M3x10 screw to secure the shaft against falling out. Tighten the screw to the surface of the printed part.
- ◆ Turn the side with one motor towards you.
- ◆ Use second M3x10 screw to secure the shaft against falling out. Tighten the screw to the surface of the printed part.

STEP 32 Tensioning parts preparation

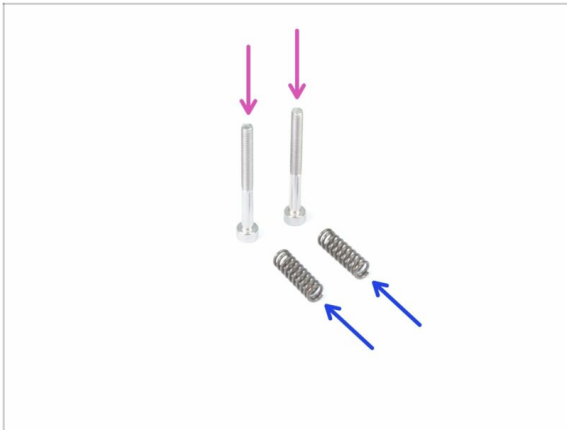

- For the following steps, please prepare:
- M3x30 screw (2x)
- spring 5x15s (2x)

STEP 33 Tensioning system assembly

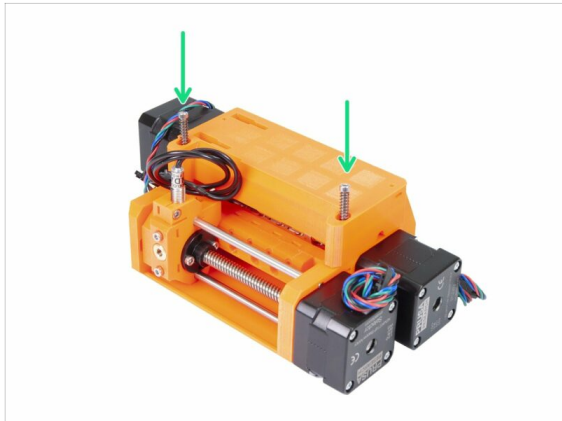

- Slide the springs on the screws.
- Insert screws with the springs in the holes on idler-body.
- Tighten the screw heads slightly below the surface of the printed part.

STEP 34 It's Haribo time!

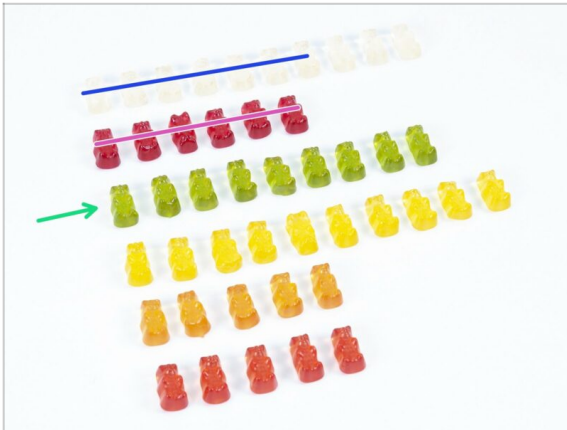

- ◆ Quite challenging chapter, wasn't it?
- ◆ Pulley body assembly required your attention, eat no less than 20 % of all bears.

STEP 35 Final check of the MMU2S unit



- ◆ Make sure all parts are tightened.
- ◆ The next chapter is waiting! [6. Electronics and MMU2S unit assembly](#)

6. Electronics and MMU2S unit assembly

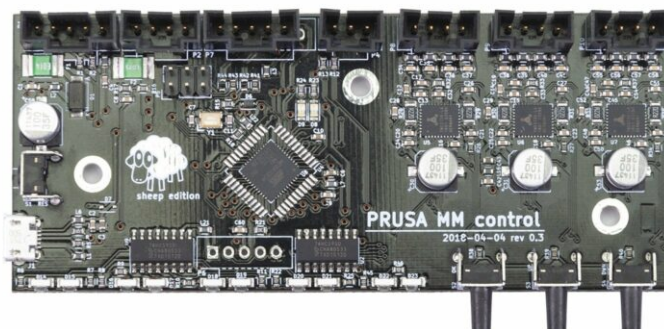

STEP 1 Tools necessary for this chapter

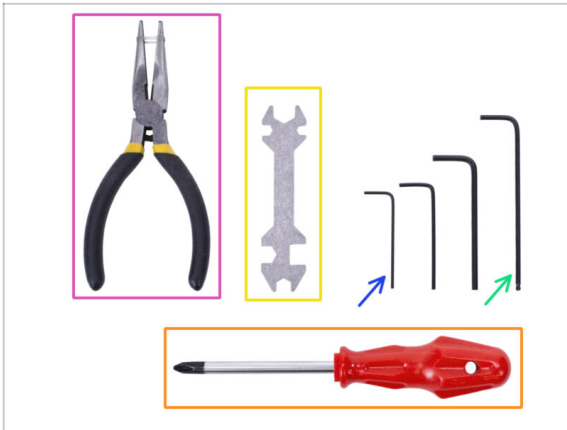

● **Please prepare tools for this chapter:**

- 2.5mm Allen key for M3 screws
 - 2mm Allen key for nut alignment
 - Needle-nose pliers for zip tie trimming
 - Philips screw-driver for power cable assembly
 - Universal wrench to tighten the QSM fittings
- ⓘ Older units may include a side wrench 8 mm.

STEP 2 Electronic parts preparation

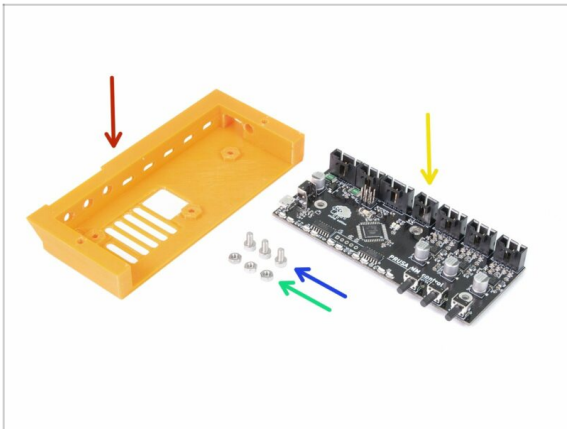

● **For the following steps, please prepare:**

- mmu2-ele-cover (1x)
- M3x6 screw (3x)
- M3n nut (3x)
- MMU2S control board (1x)

STEP 3 Electronics assembly

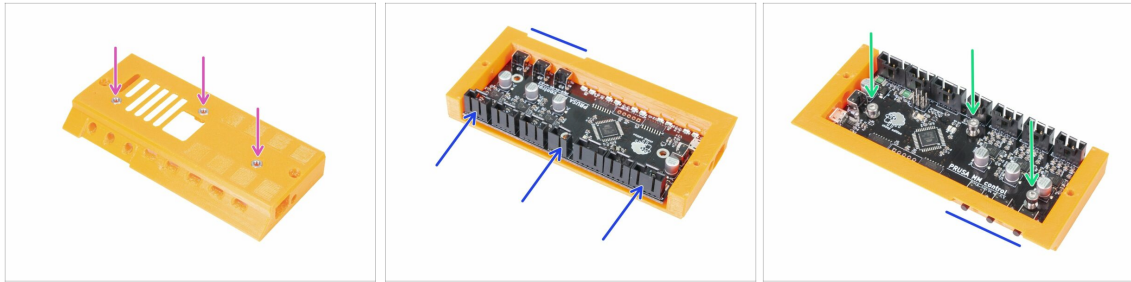

- ◆ Insert three M3n nuts in the ele-cover. Use a flat surface to push them in if necessary.
- ◆ Slide in the MMU2S control board. Make sure the three buttons are all the way through on the other side.
- ◆ Secure the board with three M3x6 screws. Tighten carefully.
- ⓘ Tip: If you can't press the nuts in, use a M3x6 screw to pull the nuts in before you slide in the board.

STEP 4 Cables preparation

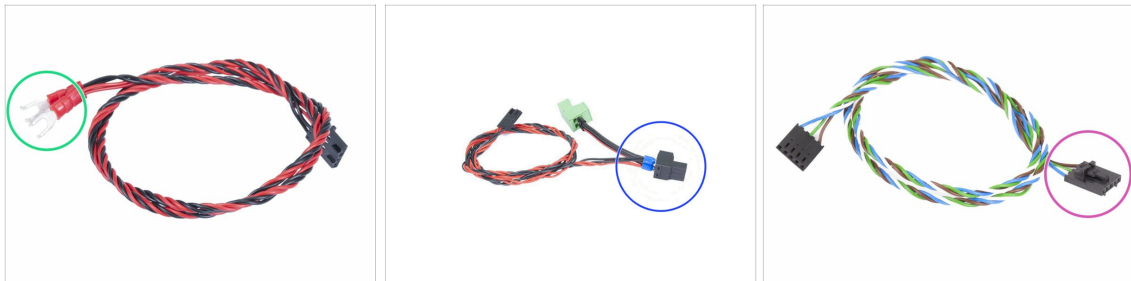

◆ **For the following steps, please prepare:**

- ◆ Power cable for the MK3S/+ (1x)

OR

- ◆ Power cable for the MK2.5S (1x)

⚠ **Use the correct power cable for your printer type!**

- ◆ Signal cable (1x)

⚠ **Note the signal cable has two different connectors! One is smooth without **safety latch** and the other one has a latch. Use the latch for the MMU2S board.**

STEP 5 Connecting the cables

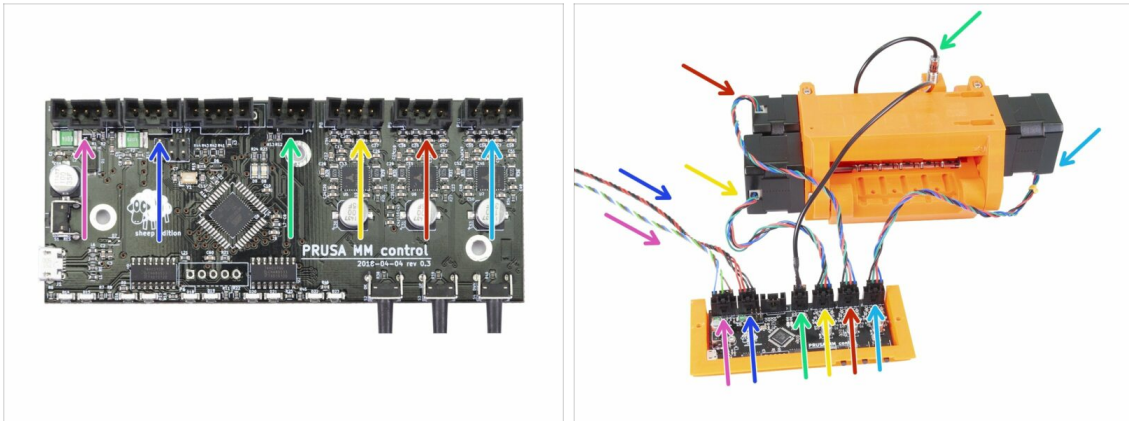

● Prepare the MMU2S unit and the board assembly as in the picture. Follow the cables to connect them correctly. Start from the left:

- Signal cable (use side with safety latch)
- Power cable
- SuperFINDA sensor cable
- Pulley motor cable
- Selector motor cable
- Idler motor cable

STEP 6 Cable management parts preparation

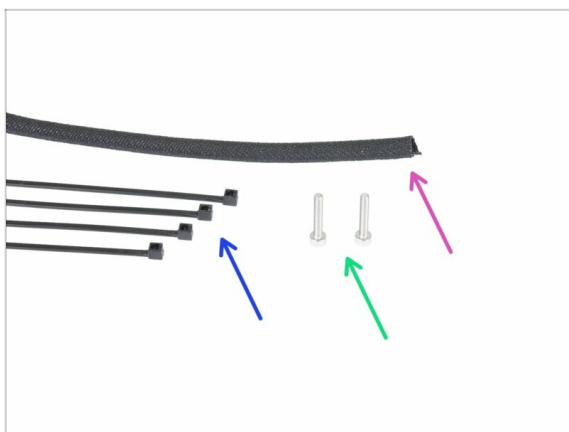

● For the following steps, please prepare:

- Textile sleeve (1x)
- Zip tie (4x)
- M3x18 screw (2x)

STEP 7 Cable management (part 1)

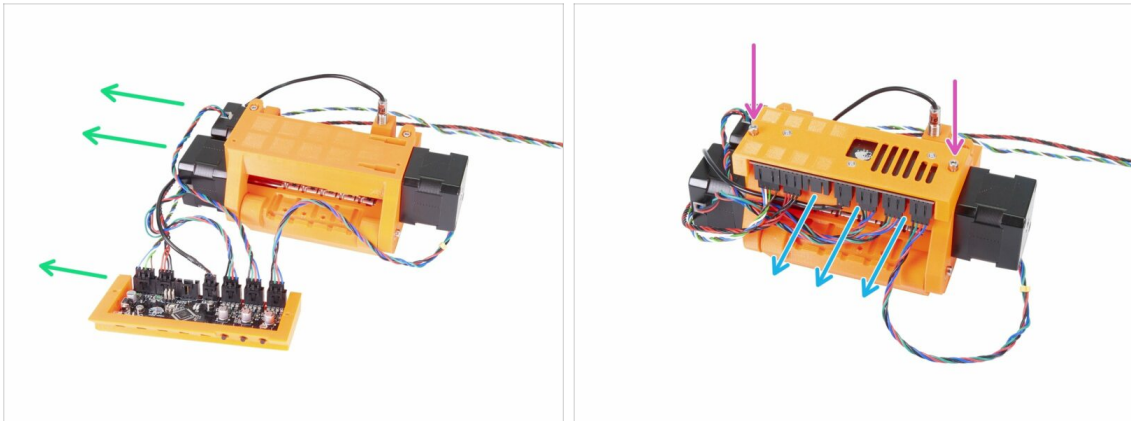

- Prepare the MMU2S unit and the electronics assembly like in the picture. Position the side with two motors to the left and signal cable to the left as well.
- Place the electronics on the MMU2S unit. The connectors must be facing towards you.
- Secure the electronics assembly with two M3x18 screws.

STEP 8 Cable management (part 2)

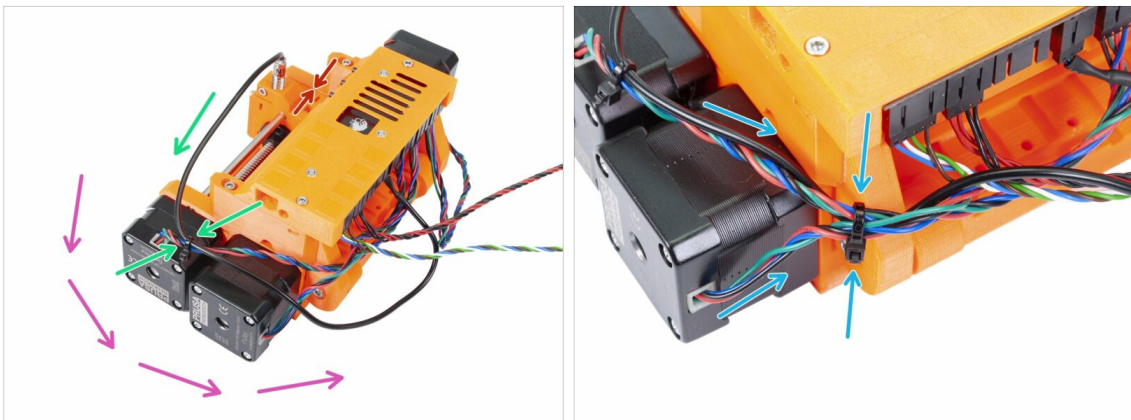

- ⚠ **Make sure the selector with SuperFINDA is all the way to the side as in the picture!**
- We will do the cable management starting from the SuperFINDA sensor and proceed counter-clockwise. Note the arrows.
- ⓘ Tighten the cables firmly, but gently at the same time. You can damage (break) the wires.
- Carefully guide the cable from the SuperFINDA sensor and couple it with the cable from the Selector motor. Use the first zip tie.
- Continue with the cable bundle and add the Pulley motor cable. Tighten these three cables using a second zip tie near the edge of the printed part (idler-body).

STEP 9 Cable management (part 3)

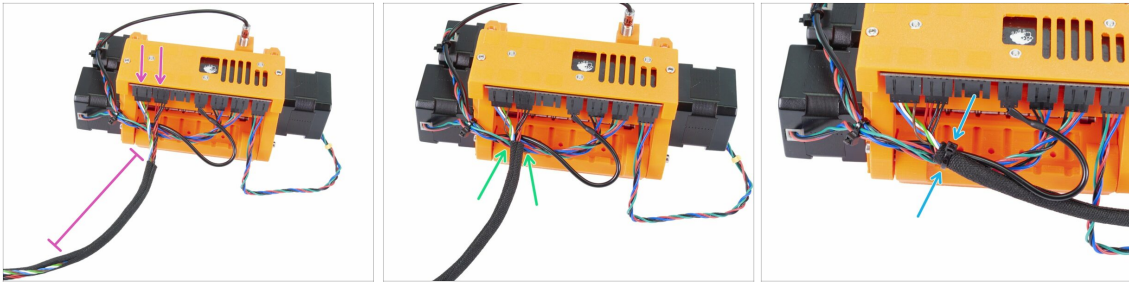

- ◆ Take the signal and power cable (first two from the left). Bundle them together and wrap around 10 cm (3.94 inch) in the textile sleeve.
- ◆ Slide the sleeve towards the MMU2S unit as much as the cable allows.
- ◆ Take the bundle from the motors and SuperFINDA add the textile sleeve above it, and tighten it using the third zip tie.
- ◆ Finish wrapping the cables in the textile sleeve.

STEP 10 Cable management (part 4)

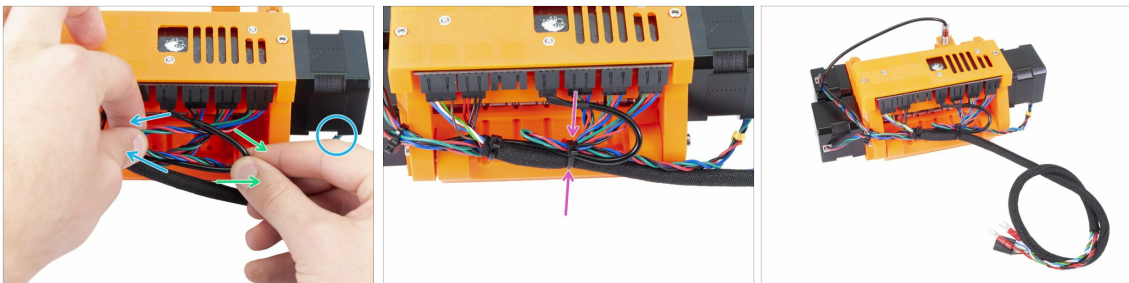

- ◆ Now using the left hand take the cable from the Idler motor and pull it gently to the left.
- ◆ Using the right hand take the cable from SuperFINDA sensor (black) and pull it gently to the right.
- ◆ Use the fourth zip tie and bundle all the cables together.
- ◆ Final cable management should be similar to the last picture.
- ⓘ Note: for the MK2.5S, there will be different connectors at the end of the cable bundle.

STEP 11 PTFE tubes parts preparation

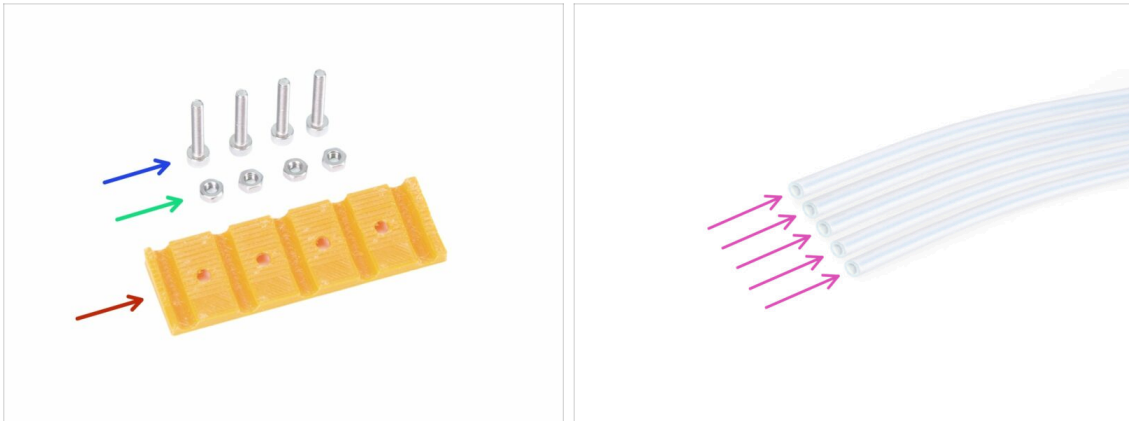

● For the following steps, please prepare:

● mmu2-rear-PTFE-holder (1x)

● M3x18 screw (4x)

● M3n nut (4x)

● PTFE tube 4x2x650 (5x)

ⓘ PTFE tubes are installed as the last item to avoid damage to them. Be careful during the assembly ;)

STEP 12 PTFE tubes assembly (part 1)

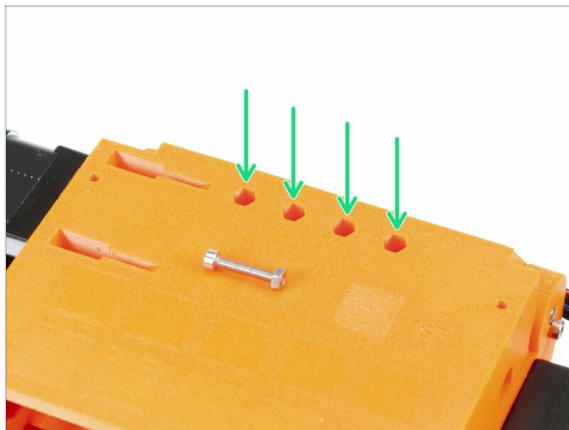

● Carefully turn the entire MMU2S unit upside-down.

● Slide in the M3n nuts. Use a M3x18 screw to press them in. Use your hand, hammer shouldn't be necessary.

● The hole for each nut is slightly narrower on the other end, therefore the nut should have a snug fit.

STEP 13 PTFE tubes assembly (part 2)

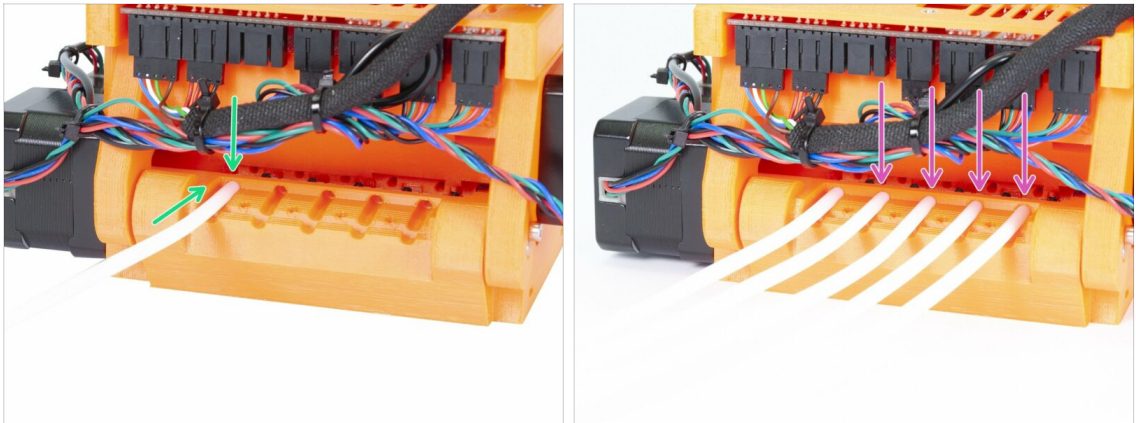

- Take the first PTFE tube and slide it inside the MMU2S unit. All five tubes are bent in one direction, make sure the free end is now pointing up.
- There is a circular hole for each PTFE tube, you should be able to press at least 0.5 to 1 mm (0.02 - 0.04 inch) of the tube inside the hole.
- Continue by pressing in remaining four PTFE tubes.

STEP 14 PTFE tubes assembly (part 3)

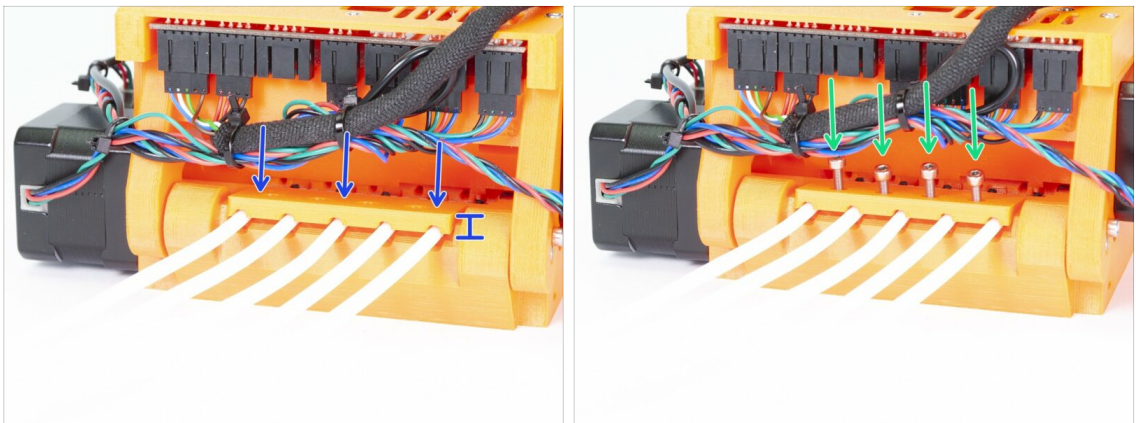

- Place the rear-PTFE-holder on the top of the PTFE tubes. Notice the printed part has thicker side, which must be facing out.
- Secure the rear-PTFE holder using four M3x18 screws. Tighten the screws fully only after you ensure proper alignment of the printed part! Otherwise, you risk squishing the tubes and future filament jams.

STEP 15 Frame holder parts preparation

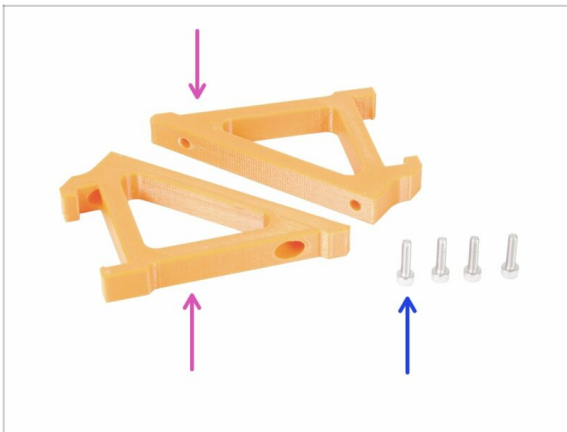

● For the following steps, please prepare:

● mmu2-frame-holder (2x)

● M3x12 screw (4x)

⚠ Be extra careful with the holders from now on. If you break them, you won't be able to mount the MMU2S unit on the frame.

STEP 16 Frame holder assembly

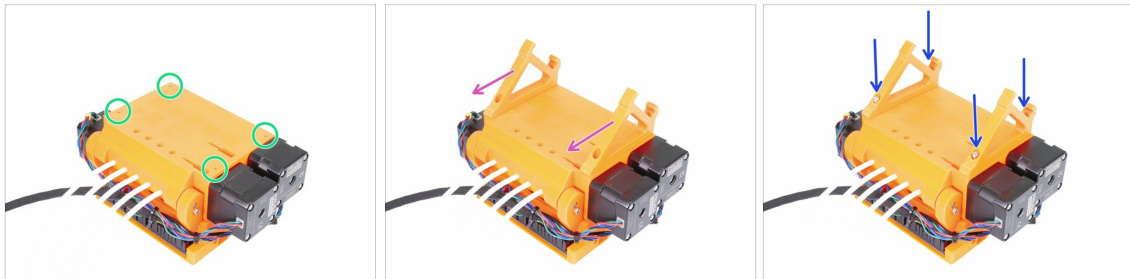

⚠ While the MMU2S unit is turned upside down, be EXTRA careful with the SuperFINDA cable, which can get broken, if you tilt the unit on the SuperFINDA sensor.

- Turn the MMU2S unit upside down like in the first picture. Locate the four holes for the M3 screws. Make sure there are nuts in them.
- Place both frame-holder parts on the MMU2S unit. The longest inclined part should be in the direction of the PTFE tubes.
- Ensure once again the correct orientation of the frame holders.
- Secure the holders using four M3x12 screws.

STEP 17 MMU2S unit is finished!



- Great job, the MMU2S unit is finished!
- Compare the picture to your assembly.
- ⚠ DO NOT ATTACH** the MMU2S unit **onto the printer FRAME** yet!!! Wait for the instructions.

STEP 18 PTFE tube parts preparation



- For the following step, please prepare:
- PTFE tube 4x2x360 (1x)
- Fitting QSM-M5 (2x)
- i** Note this tube, can be also white. The dimensions and properties are the same.

STEP 19 PTFE tube assembly

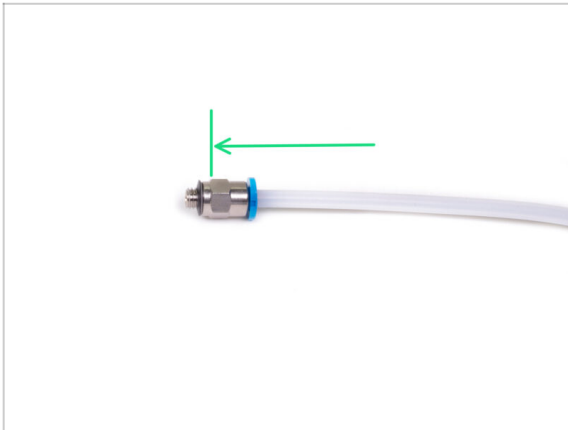

- ◆ Take one QSM-M5 fitting and slide the PTFE tube inside. You should feel the tube snapped in.
- ◆ Repeat this procedure on the other end.
- ⓘ As an alternative, you can first screw the fittings in the printer and then slide the tube in.

STEP 20 Assembling the MMU2S unit (part 1)

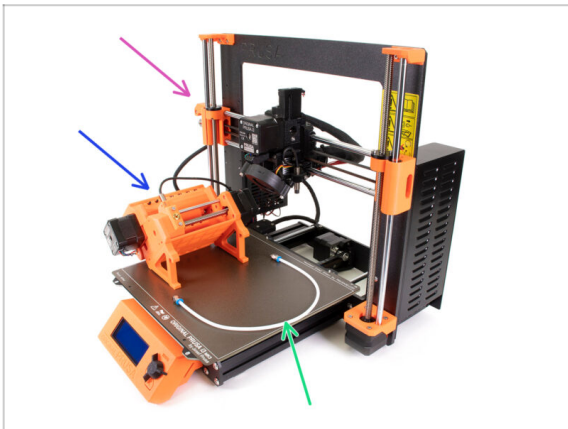

- ◆ **For the following steps, please prepare:**
- ◆ Original Prusa i3 MK3S/+ or MK2.5S printer
- ◆ MMU2S unit
- ◆ PTFE tube
- ◆ 8mm wrench
- ⚠ **Before you plug in the MMU2S unit to the printer, please **make sure the printer is TURNED OFF!****

STEP 21 Assembling the MMU2S unit (part 2)

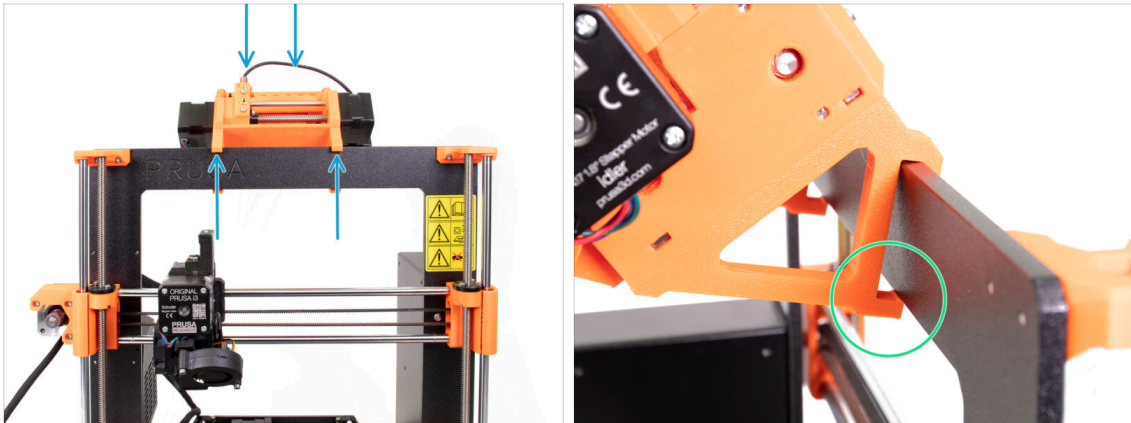

- ❶ The MMU2S unit should be placed in the middle on the top part of the aluminium frame (next to the Prusa logo).
- ➊ Place the unit on the frame, do not try to fix it for now.
- ➋ Look from behind the printer, there are "clamps" on the MMU2S unit, which must be snapped (locked) to the frame. **Don't do it now**, wait for the next step!

STEP 22 Assembling the MMU2S unit (part 3)



- ➌ Make sure once more the unit is in the middle of the frame, once we engage the clamps, **you won't be able to move it!**
- ➍ Using both hands, apply equal pressure along the top part of the MMU2S unit. Press downwards and slightly towards the frame. Press until the clamps lock to the frame.
- ➎ Check on the front side of the frame, both clamps of the holder are fully engaged.
- ❶ That's it for the MMU2S unit ;)

STEP 23 Connecting the extruder and MMU2S unit

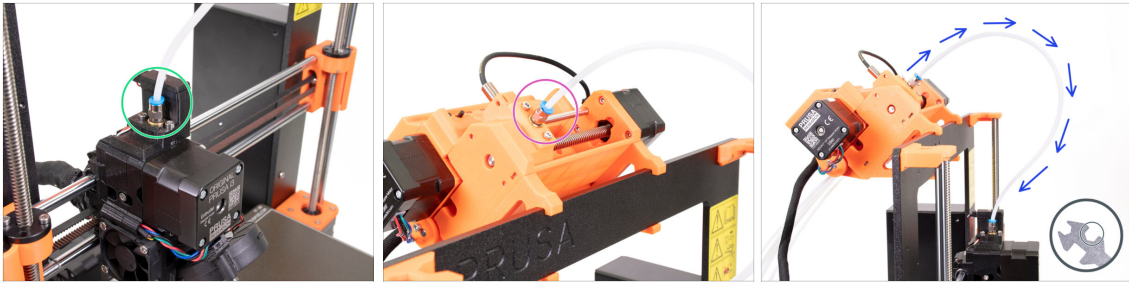

- Take the PTFE tube you prepared earlier and connect it to the extruder. Both ends of the tube are the same. Use fingers to tighten the thread.
- Take the second end of the tube and connect it to the MMU2S unit. Tighten the fitting using fingers.
- Check both fittings on the tube are perpendicular to the surface of the extruder and the MMU2S unit. Make sure the tube is not distorted or twisted.
- Tighten both fittings using the 8mm cutout of the wrench, be very careful when tightening, don't use an excessive force!

STEP 24 Connecting the electronics

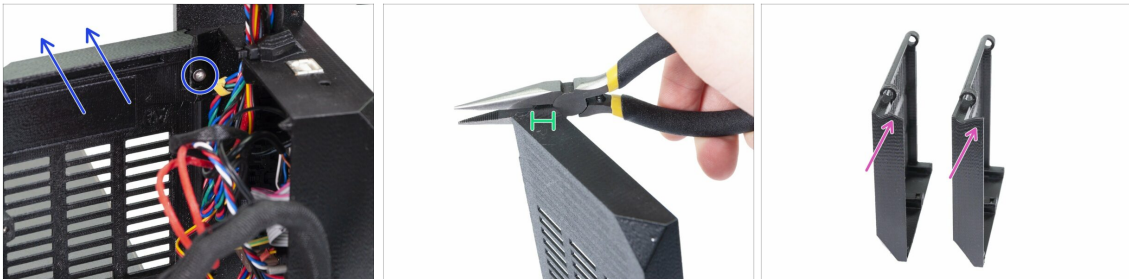

- WARNING:** we need to cut part of the plastic. Make sure you wear protective eyewear!
- Release and remove the M3x10 screw in the upper hinge. Then remove the hinge and the door.
- Using pliers carefully cut the corner of the door. We need to create a space for the MMU2S unit cable bundle.
- Comparison between the trimmed door (left) and the original shape (right).

STEP 25 Connecting the electronics

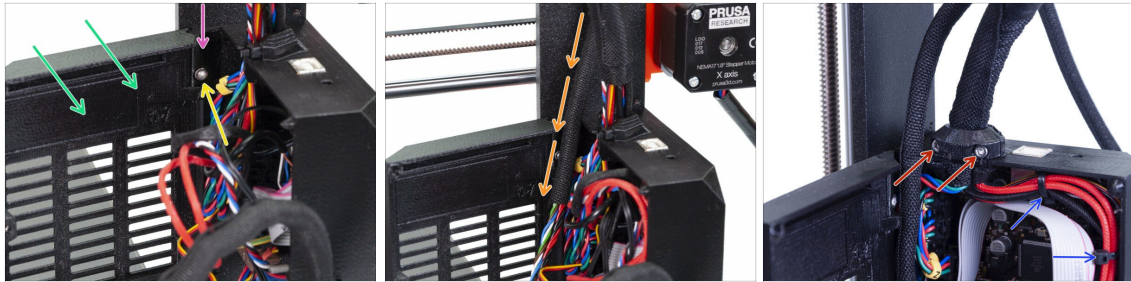

- ◆ Place the door back.
- ◆ Insert back the hinge.
- ◆ Tighten the M3x10 screw.
- ◆ Insert the cable bundle from the MMU2S unit.
- ◆ Place back the clip and tighten it.
- ◆ Attach the extruder cable bundle to the hooks on the inside of the Einsy-base by using two zip-ties.
- ◆ Now, let's connect the cables to the board. Select the next steps based on the printer that you have.

STEP 26 Connecting the extruder MK3S/+ (optional)

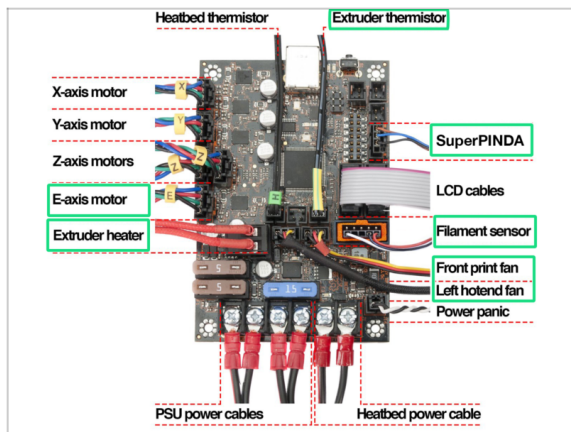

⚠ Connections differ depending on the printer you have. For the MK3S/+, please use this step. For the MK2.5S please skip to the following one.

- ◆ Follow the diagram in case you need to reconnect the extruder cables into the Einsy Rambo board.
- ◆ In case you upgraded from the MK3 printer, you have to reconnect the entire extruder cable bundle.

STEP 27 Connecting the electronics MK3S/+

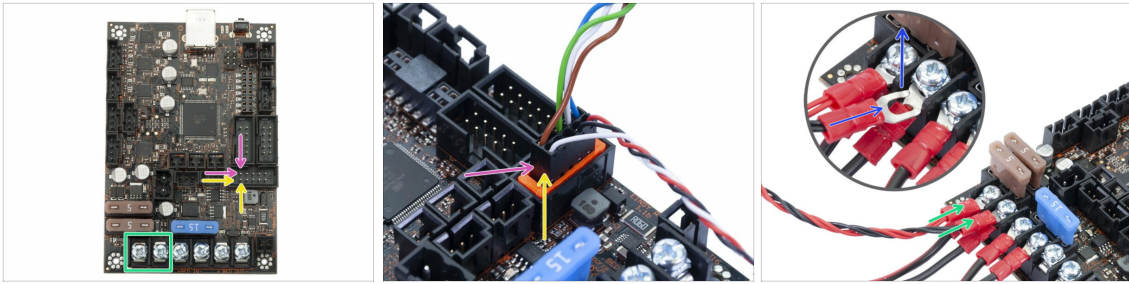

- ⚠ Connecting MMU2S unit to the printer differs depending on the printer you have. **For the MK3S/+, please use this step.** For the MK2.5S please skip to the next.
- MMU2S Signal cable (upper row of the pins, brown wire in the connector facing left)
- IR filament sensor cable (white wire facing left)
- ⚠ **Make sure the signal cable is properly connected to all pins!**
- Power cable (add it to the first two clamps from the left, leave the PSU cables connected). **Red wire is positive** and in the first slot, **black wire is negative** and in the second.
- The power cable connector "fork" has bended ends, make sure they point up, see the picture.
- ⚠ **Make sure the power cables are tightened firmly!**
- ⓘ Use the Philips screw-driver to release the screws on the EINSY Rambo board.

STEP 28 Connecting the electronics MK2.5S

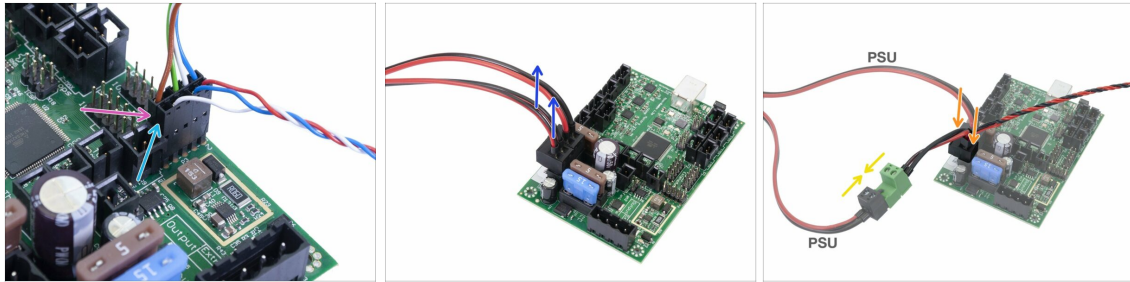

⚠ This step is for the MK2.5S owners, in case you have MK3S/+, please skip the following two steps.

- Signal cable (upper row of the pins, brown wire in the connector facing left)
- IR-sensor cable (white wire facing to the left)

⚠ Make sure the signal cable is connected to all pins! You can use the filament sensor connector to verify the alignment.

- Follow the cables from the PSU and unplug one connector from the RAMBo board (both are the same).
- Connect the PSU cable to the power cable from the MMU2S unit. See the picture and ensure the connector is all the way in.
- Plug the power cable from the MMU2S unit to the board, where the PSU cable was plugged previously.
- Make sure the power cables are connected firmly!

STEP 29 Connecting the electronics MK2.5S (optional)

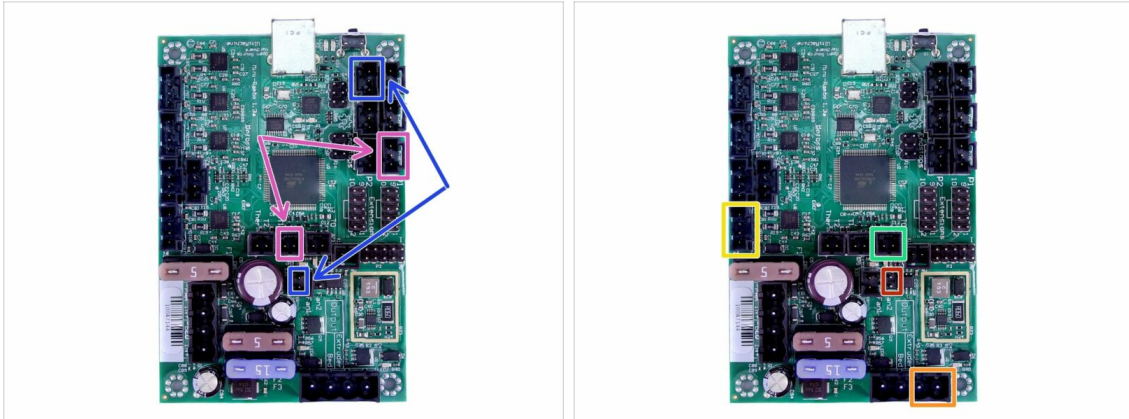

- In case you upgraded from MK2.5 printer, you have to reconnect the entire extruder:
- P.I.N.D.A. probe (v-cable, 4 wires)
- Left hotend fan (v-cable, 3 wires)
- Extruder motor (yellow label with "E")
- Extruder heater
- Extruder thermistor (yellow/green heat shrink, orientation does not matter)
- Front print fan (red heat shrink, ensure that the red wire is closer to the extruder thermistor connector)

STEP 30 Connecting the electronics

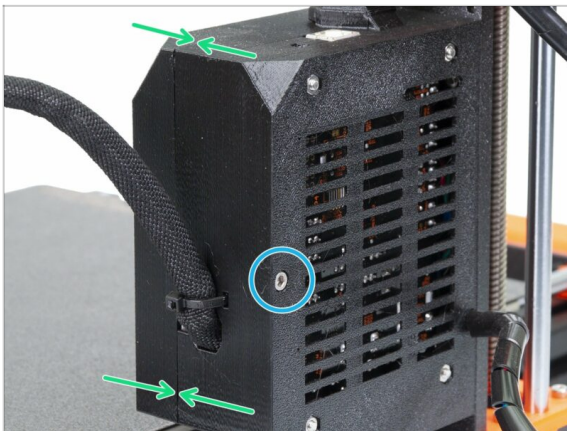

- Close the door and make sure no wire is pinched.
- Tighten the M3x40 screw.

STEP 31 It's Haribo time!

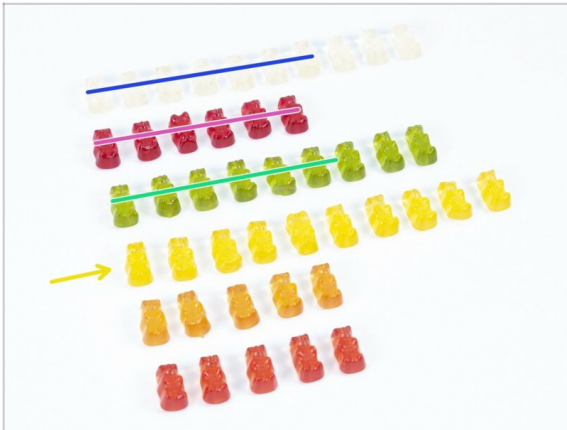

- ◆ Your sweets are well deserved, this was a tough part!
- ◆ Electronics assembly is the last chapter with high level of difficulty, consume 25 %.

STEP 32 Final check!

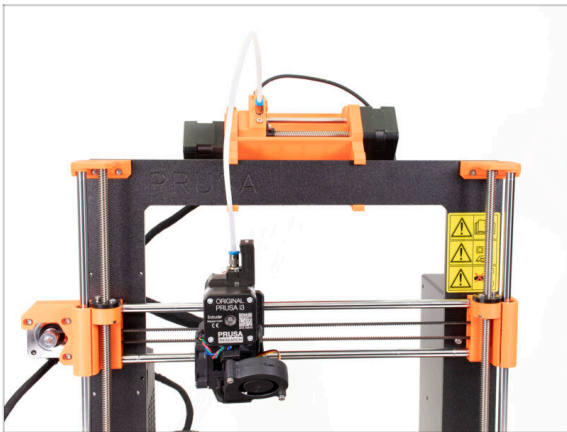

- ◆ Congrats, you've made through the toughest part of the build!
- ◆ Last assembly is in front of us! **7. Spool holder and buffer assembly**

7. Spool holder and buffer assembly



STEP 1 Tools necessary for this chapter

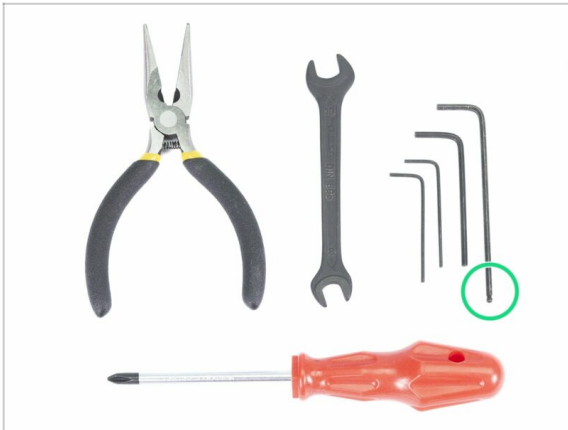

- Please prepare tools for this chapter:
- 2.5mm Allen key for M3 screws

STEP 2 Cleaning the spool holder base (optional)



- ⚠ This guide is describing an assembly of a single spool holder. Your package should include 5, simply repeat all the steps again until you finish all spool holders.
- Take the black plastic spool holder base and turn it upside down.
- Using cloth + detergent or IPA clean all four corners from dust and grease.
- Let the surface fully dry and proceed to the next step.

STEP 3 Sticking foam pads

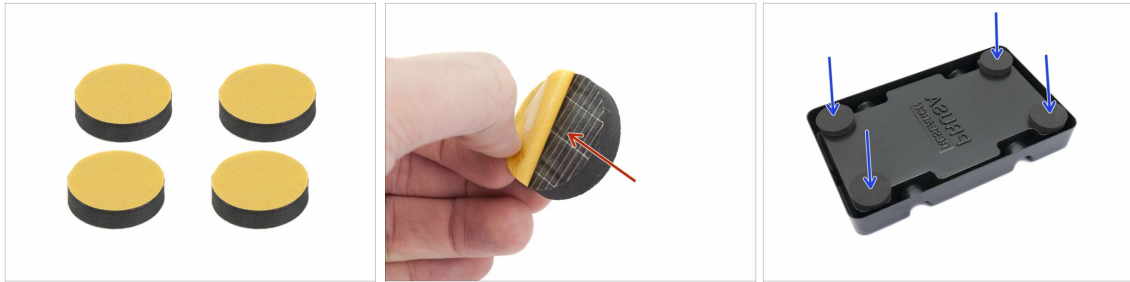

- ◆ For each spool holder base prepare 4 foam pads.
- ◆ Peel off the yellow protective film completely.
- ◆ Stick the foam pad on the bottom of the spool holder base and hold it for a while. **DON'T** use too much force, you might deform the plastic shell.
- ⓘ The foam pads are important to increase contact between the spool holder base and the surface underneath and reduce the spool holder from moving.

STEP 4 Assembling the spool shafts



- ◆ **Let's assemble the shafts holding the spools, you will need:**
- ◆ Bearings (4x)
- ◆ Shaft (2x)
- ⓘ Shafts can be black or silver, the dimensions are the same.

STEP 5 Assembling the spool shafts

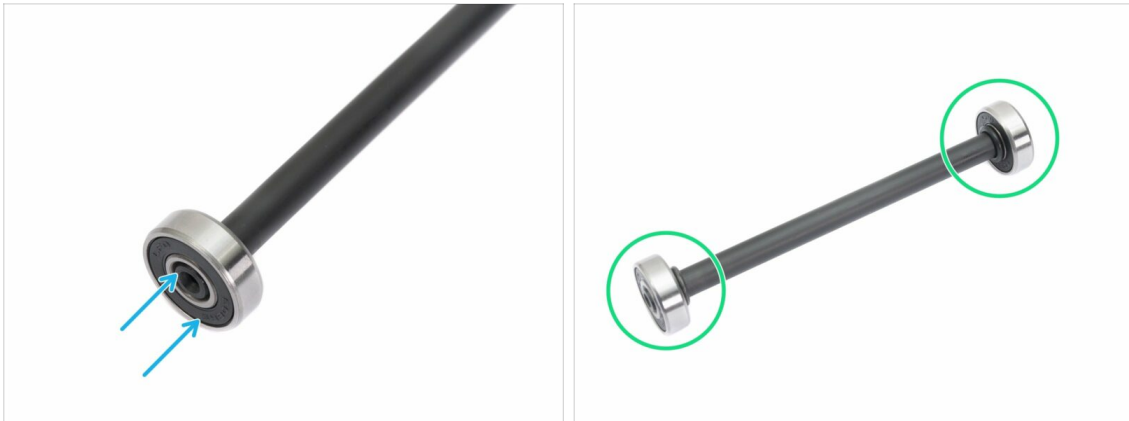

- ◆ Align the bearing with the end of the shaft.
- ◆ Assemble bearings on both sides of the shaft.
- ⓘ The rubber seals next to the bearing were used for the purpose of the photography, no need to use them.

STEP 6 Assembling the spool holder (part 1)

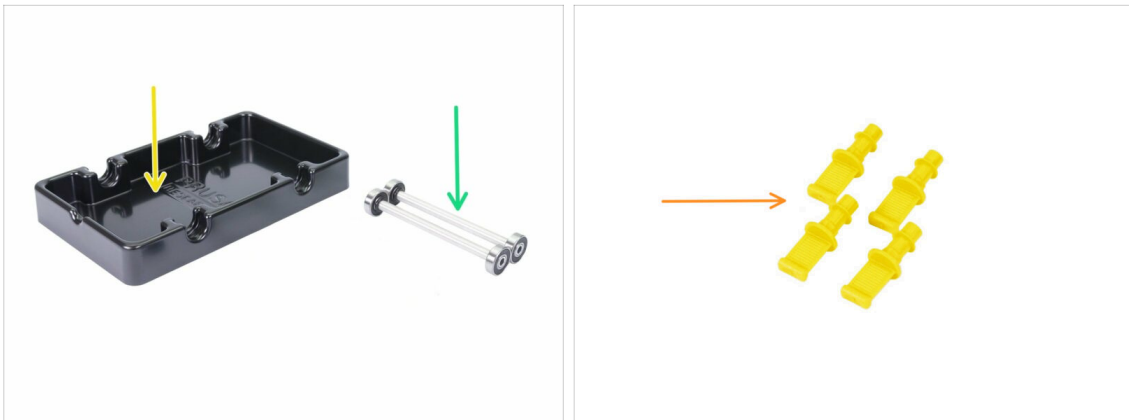

- ◆ For the following steps, please prepare:
- ◆ spool holder base (1x)
- ◆ shaft with bearings (2x)
- ◆ mmu2-s-holder-endstop (4x)

STEP 7 Assembling the spool holder (part 2)

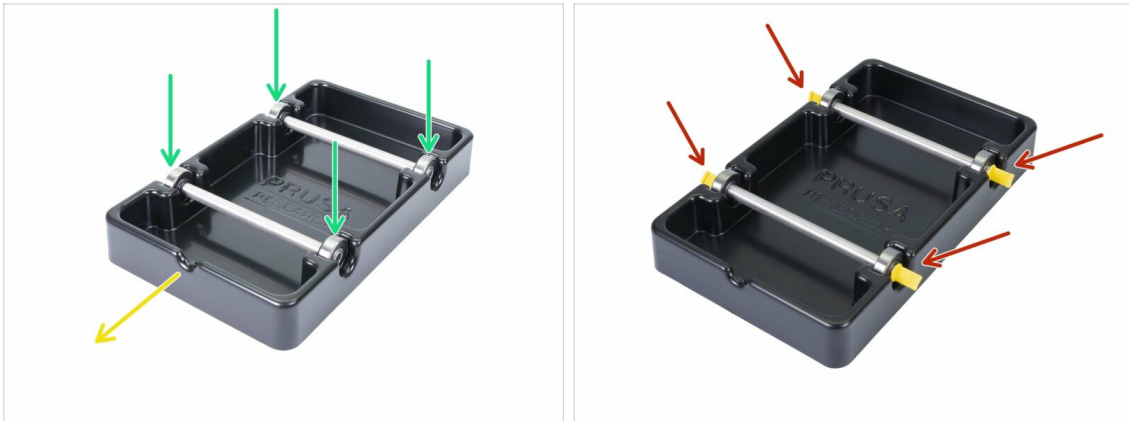

- Rotate the base with the cutout part towards you.
- Insert the shafts into the spool holder base. Make sure all four bearings are seated properly.
- Insert the endstops in all four sockets. Push them all the way in, but make sure you won't deform the spool holder base.
- Make sure the shafts can rotate freely.

STEP 8 Buffer parts preparation



● For the following steps, please prepare:





- M3x40 screw (10x)
- M3x12 screw (10x)
- M3n nut (10x)
- Buffer plate (6x)
- PTFE tube 4x2x150 mm (5x)

ⓘ The list continues in the next step.

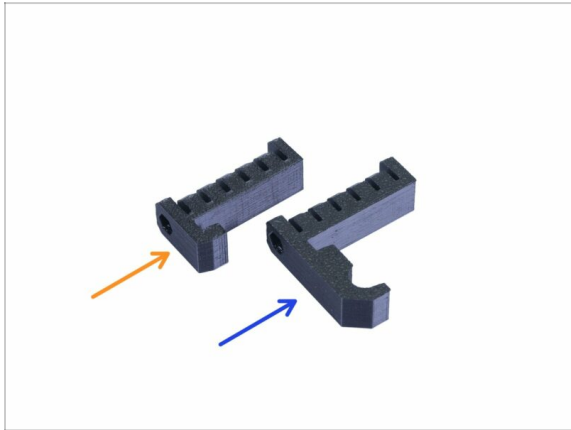
ⓘ The Buffer plates are protected by a thin protective film on one or both sides, you can remove it now. Be careful during the assembly to avoid scratches.

STEP 9 New buffer parts



-  Open the bag with the plastic parts and look for the hooks. There are two versions:
-  **New version with a longer hook** compatible with MK3S/+ and MK2.5S. Please jump to the [Step 10](#)
 -  **Old version with a shorter hook** compatible only with MK3S/+. Please jump to the [Step 15](#)
-  All printable parts are also available at prusa3d.com/prusa-i3-printable-parts

STEP 10 Buffer parts preparation (new version)



- ◆ s-buffer-printer (1x)
- ◆ s-buffer-spools (1x)
- ◆ s-buffer-spacer (4x)
- ◆ s-buffer-hook-uni (2x)

ⓘ As the names suggest, there are parts, which will connect to the printer or to the spools.

⚠ **IMPORTANT:** the holes for the PTFE tubes have to match between both parts. See the picture. **Make sure you won't flip them.**

- ◆ On one side you have 3 holes, same goes for the second printed part.
- ◆ Other side has only 2 holes.

STEP 11 Buffer assembly - printer part (new version)



- ◆ Take the larger printed part (s-buffer-printer) and place it like in the picture with two holes facing to the right.
- i Prepare something slightly heavy and tall (e.g. empty glass), we will use it in a second.
- ◆ Grab one plate and slide it in, it will fit in the slot.
- ◆ Make sure the inner surface has the protective film removed.
- ◆ The entire assembly will have a tendency to fall over, use the prepared object to support it from behind.
- ◆ Slide another 5 plates in the printed part. Make sure the surfaces with previously removed protective films are facing towards you.
- ◆ Use two M3x40 screws and push them through the printed part. Ensure the screws are all the way through.
- i Don't turn the Buffer over on its side yet.

STEP 12 Buffer assembly - spools part (new version)

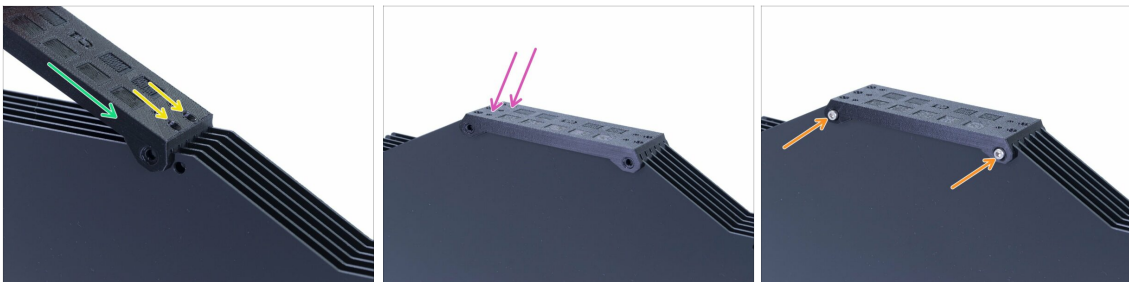

- ◆ Arrange the plates on top of the Buffer and slide in the second printed part (s-buffer-spools).
- ◆ Make sure the side with two holes is on the right.
- ◆ Seat the printed part on the other side as well.
- ◆ Secure the printed part using two screws M3x40.
- i Don't turn the Buffer over on its side yet.

STEP 13 WARNING: tightening the parts (new version)

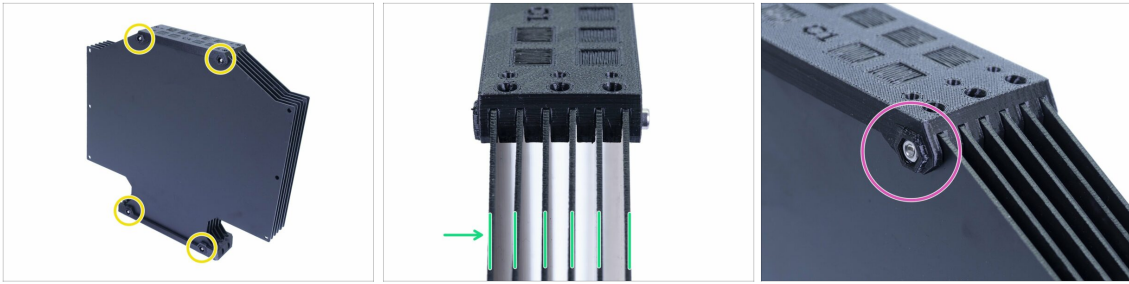

- ◆ Now turn the Buffer and place four nuts on the screws. **Before you start tightening, please read the following instructions:**
- ◆ **DON'T TIGHTEN** the screws too firmly. You will deform the plates and the Buffer might not work properly. Make sure the plates are parallel and not bent.
- ◆ It is enough just to catch the nut (use its entire internal thread).
- i Use this approach on all parts, which are holding the plates.

STEP 14 Adding the spacers and hooks (new version)

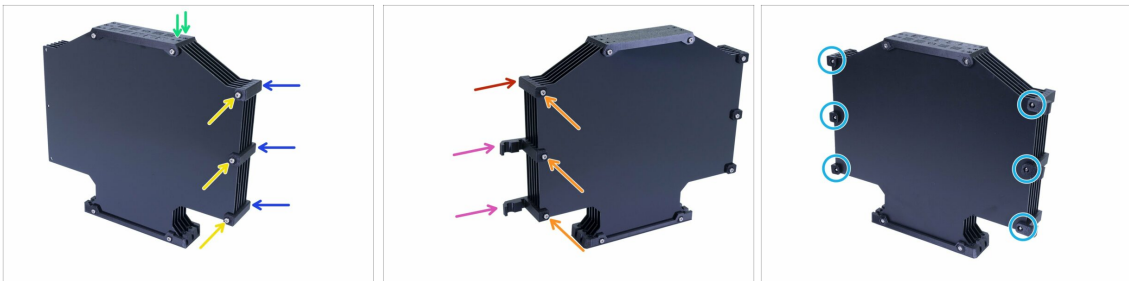

- ◆ Turn the Buffer back, two holes are facing to the right again.
- ◆ Take three s-buffer-spacer parts and place them on the side with two holes.
- ◆ Secure each s-buffer-spacer with a M3x40 screw.
- ◆ Take two s-buffer-hook-uni parts and place them on the other side. *This position of hooks is compatible both with MK3S and MK2.5S, but you can rearrange it.*
- ◆ Take the last s-buffer-spacer and place it to the corner.
- ◆ Secure each printer part with a M3x40 screw.
- ◆ Use six M3n nuts from the other side and tighten the screws. Keep in mind the proper tightening. **Avoid deforming the plates!**
- ◆ Now, skip to the [Step 20](#).

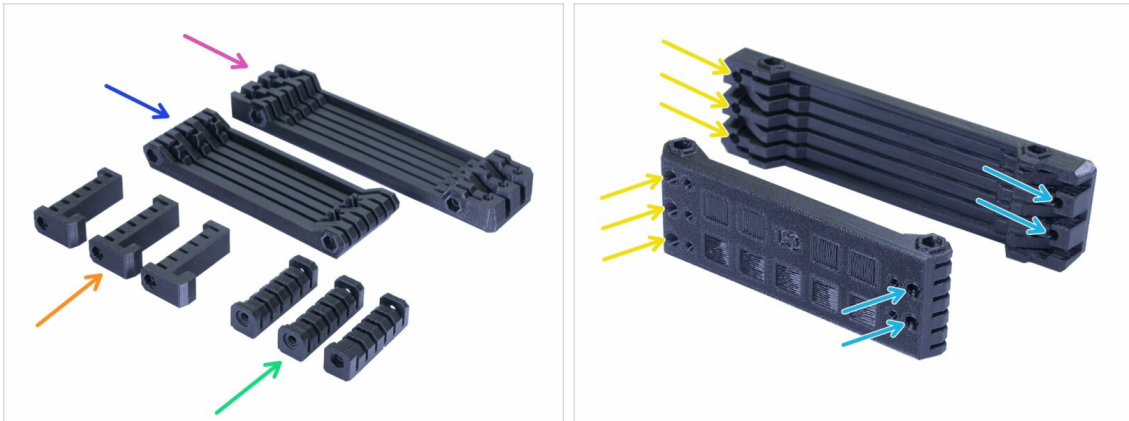
STEP 15 Buffer parts preparation (old version)

● s-buffer-spacer (3x)

● s-buffer-spacer-hook (3x)

● s-buffer-printer (1x)

● s-buffer-spools (1x)

ⓘ As the names suggest, there are parts, which will connect to the printer or to the spools.

⚠ **IMPORTANT:** the holes for the PTFE tubes have to match between both parts. See the picture. **Make sure you won't flip them.**

● On one side you have 3 holes, same goes for the second printed part.

● Other side has only 2 holes.

STEP 16 Buffer assembly - printer part (old version)

- ◆ Take the larger printed part (s-buffer-printer) and place it like in the picture with two holes facing to the right.
- i Prepare something slightly heavy and tall (e.g. empty glass), we will use it in a second.
- ◆ Grab one plate and slide it in, it will fit in the slot.
- ◆ Make sure the surface facing towards you have the protective foil removed. If not, remove it.
- ◆ The entire assembly will have a tendency to fall over, use the prepared object to support it from behind.
- ◆ Slide another 5 plates in the printed part. Make sure the inner surfaces have the protective foil removed.
- ◆ Use two M3x40 screws and push them through the printed part. Ensure the screws are all the way through.
- i Don't turn the Buffer over yet.

STEP 17 Buffer assembly - spools part (old version)

- ◆ Arrange the plates on top of the Buffer and slide in the second printed part (s-buffer-spools).
- ◆ Make sure the side with two holes is on the right.
- ◆ Seat the printed part on the other side as well.
- ◆ Secure the printed part using two screws M3x40.
- i Don't turn the Buffer over yet.

STEP 18 WARNING: tightening the parts (old version)

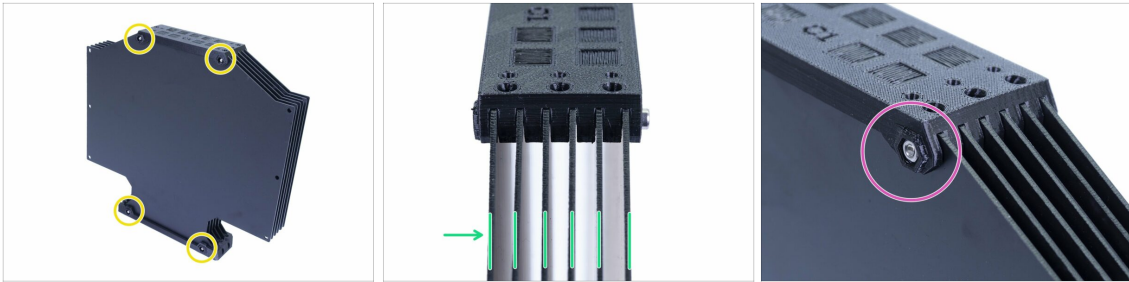

- ◆ Now turn the Buffer and place four nuts on the screws. **Before you start tightening, please read the following instructions:**
- ◆ **DON'T TIGHTEN** the screws too firmly. You will deform the plates and the Buffer might not work properly. Make sure the plates are parallel and not bent.
- ◆ It is enough just to catch the nut (use its entire internal thread).
- i Use this approach on all parts, which are holding the plates.

STEP 19 Adding the spacers on both sides (old version)



- ◆ Turn the Buffer back, two holes are facing to the right again.
- ◆ Take three s-buffer-spacer parts and place them on the side with two holes.
- ◆ Secure each s-buffer-spacer with a M3x40 screw.
- ◆ Take three s-buffer-spacer-hook parts and place them on the other side.
- ◆ Secure each s-buffer-spacer-hook with a M3x40 screw.
- ◆ Use six M3n nuts from the other side and tighten the screws. Keep in mind the proper tightening. **Avoid deforming the plates!**

STEP 20 Adding the PTFE tubes (both versions)



- Take the 150mm PTFE tubes and slide them in to the smaller of the two printed parts. Make sure the PTFE tube sticks out on the other side (inside the Buffer) just 2-3 mm, not more.
- Secure the PTFE tubes using five M3x12 screws. You can tighten them slightly above the surface.
- ⚠ **CHECK EACH PTFE TUBE** with a piece of filament to ensure it can move smoothly inside the tube. If not, release the screw a bit.

STEP 21 It's Haribo time!

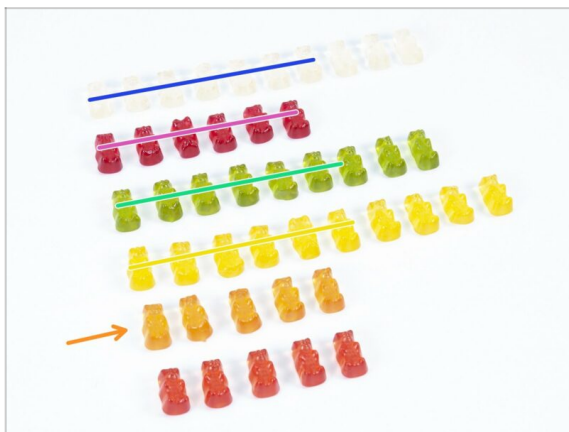

- That was easy, right?
- Spool holders and Buffer are easy to make, research shows that 10 % is enough.

STEP 22 Final check



- Did you assemble all five spool holders and the Buffer?
- Do they look like those in the photo? *Note that the hooks on the buffer will differ depending on your version.*
- ⓘ There are 5 screws (M3x12) remaining, keep them for connecting the printer tubes to the buffer, later while reading the Handbook.
- Let's continue with in the next chapter.

8. Preflight check & Calibration

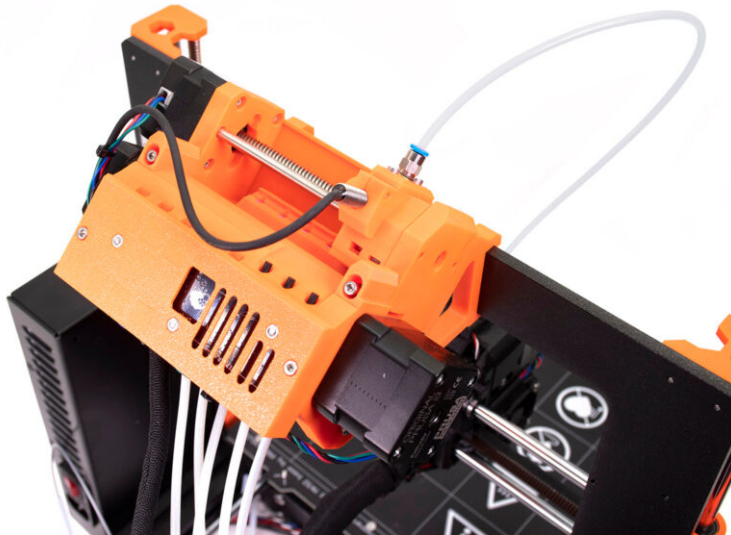

STEP 1 SuperPINDA calibration preparation (optional)

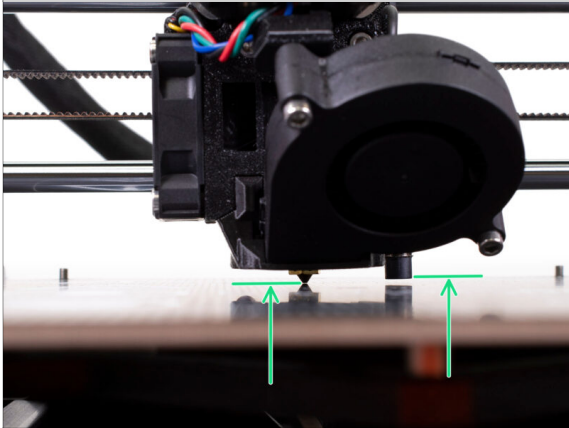

- ⚠ IMPORTANT:** SuperPINDA adjustment is needed only in case you have disassembled the entire extruder and moved the sensor. If not (e.g. MK3S and MK3S+ owners), you can skip to step 5.
- 🟢 In the upcoming steps, we are going to re-calibrate the height of the SuperPINDA probe on the extruder.
- ⬛ This calibration procedure is the same for printers equipped with the older P.I.N.D.A leveling sensor.
- 📄 While moving the extruder, the X-axis motor works as an alternator. You will generate a small amount of electricity and the LCD might flicker. Move the extruder reasonably slowly and in the future always use the printer's controls.

STEP 2 SuperPINDA adjustment (part 1)



- ⚠** Ensure the printer is turned off and not plugged in.
- ⚠** Don't place the steel sheet onto the heatedbed during the entire SuperPINDA probe adjustment process. Wait for the Z calibration.
- 🟡 Move the extruder manually all the way to the left.
- 🟠 By rotating BOTH threaded rods at the same time on the Z-axis move the nozzle until you reach the heatbed. Try rotating both the rods equally!
- ⚠** Check again while looking from a different angle that the nozzle is slightly touching the heatbed. Make sure the nozzle is not scratching the surface and that the heatbed doesn't get bent during the whole procedure.

STEP 3 SuperPINDA adjustment (part 2)

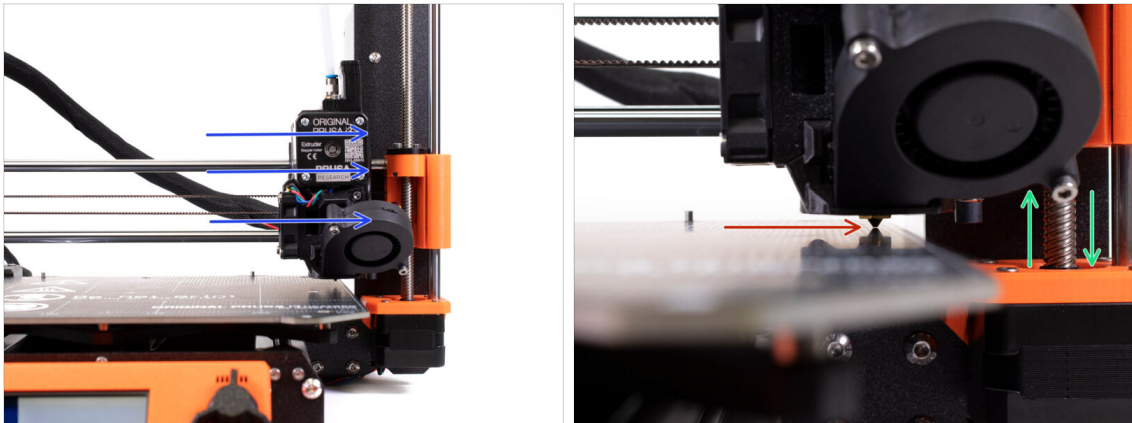

- Move the extruder carefully all the way to the right.
- ⚠ Be careful not to scratch the surface during the movement! If the nozzle starts digging into the heatbed, rise the right side of the X-axis by rotating the right Z motor slightly clockwise.
- If an adjustment is needed, you can lower the nozzle height by rotating the right Z motor counter-clockwise.

STEP 4 SuperPINDA adjustment (part 3)

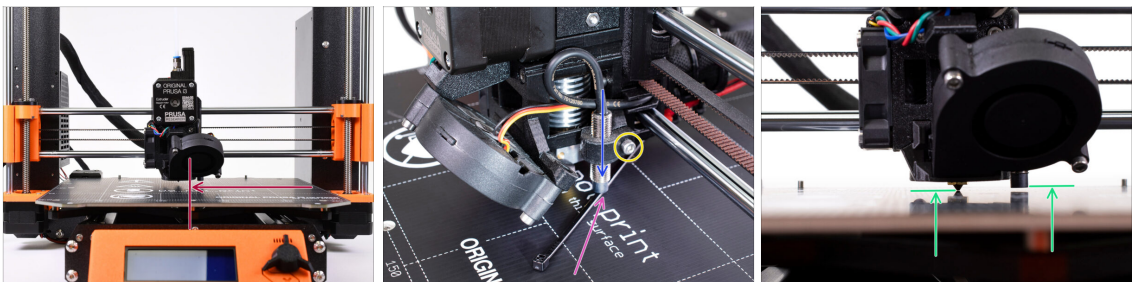

- Move the extruder to the center of the X-axis.
- Take a zip tie from the package and place it under the SuperPINDA sensor. Use the middle part of the zip tie, not the tip.
- Release the screw holding the SuperPINDA sensor and gently press the sensor down against the zip tie.
- Tighten the screw on the SuperPINDA holder again.
- ⚠ !!! DO NOT use glue to fix the SuperPINDA probe in the holder, you won't be able to release it again !!!
- The correct height of the SuperPINDA probe compared to the nozzle should be similar to the one in the last picture.

STEP 5 Two types of the MMU firmware



⚠ IMPORTANT!!! Before you start downloading and flashing. There are two types of the firmware for the MMU2S. Make sure you can distinguish between them.

- EINSY RAMBo firmware: This firmware is flashed to the board inside the black electronics box near the heatbed. Use USB type B cable. (e.g. prusa3D_fw_MK3S_3_10_0_4481.hex or prusa3D_fw_MK25S_3_10_0_4481_RAMBo13a_en-cz.hex)
 - MMU2S board firmware: This firmware is flashed to the board inside the MMU2S unit on the top of the frame. Use Micro-USB cable. (e.g. prusa3d_fw_MMU2board_1_0_6.hex)
- ⓘ Printer and MMU2S unit firmwares are both available to download as one package at prusa3d.com/drivers
- ⓘ PrusaSlicer won't let you accidentally flash incorrect firmware to each board.

STEP 6 Download the necessary software

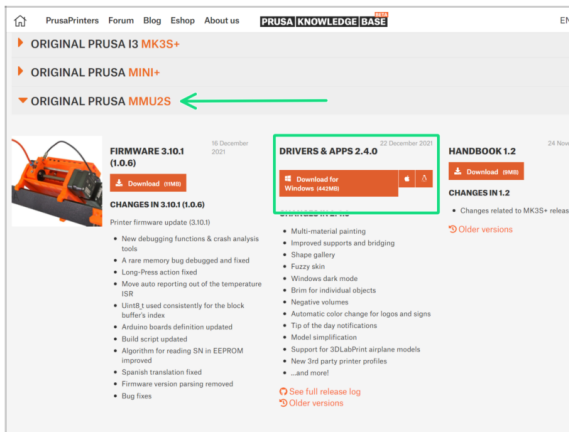

Visit help.prusa3d.com/downloads

Find the **ORIGINAL PRUSA MMU2S** on the list. In the Drivers & Apps section, download the latest package.

! Leave this page open for the next step!

Install drivers on your Windows, macOS or Linux system.

i PrusaSlicer is part of the drivers package. It includes the firmware upgrade tool. Drivers package also includes sample objects to be printed.

STEP 7 Download the new firmware

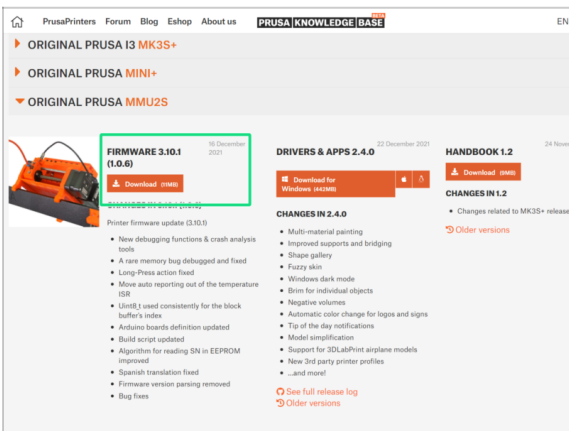

Go back to help.prusa3d.com/downloads to get the firmware for your printer and the MMU2S unit.

Download the zip file with the latest MMU2S firmware to your computer and unzip it.

i Note there are two types of the firmware for the MMU2S. One is for the MMU2S unit (top of the frame), the other for printer itself.

! For the MK3S MMU2S and MK2.5S MMU2S use firmware combo 3.9.3 and 1.0.6 or latest. Do not use MMU2 firmware for MMU2S unit.

! We will flash the firmware files in the next step. Make sure you have prepared both cables and the printer is turned ON.

STEP 8 Updating both firmwares using PrusaSlicer

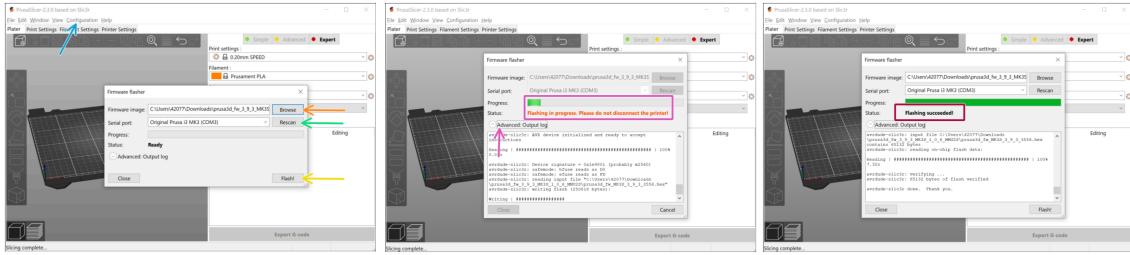

- 🛡️ Make sure the printer is turned on.
- 🛡️ Open PrusaSlicer and select **Configuration -> Flash Printer Firmware** from the top menu.
- 🟠 First, select the printer's firmware file on your harddrive (.hex). Do not place the firmware on a network share.
- 🟢 Connect the printer to your computer using the bundled USB Type B cable and select it from the menu. Hit **Rescan** if the printer is not in the list
- 🟡 Hit the **Flash** button.
- 🟣 Wait until the process is completed. You can click "Advanced: ..." to see the flashing process including a detailed log.
- 🔴 When the flashing process is done, you will be informed.
- 🛡️ **Now, repeat this step**, but this time connect the MicroUSB cable and select the firmware for the MMU2S unit.
- 📄 In case of any issues with flashing the firmware please visit our [troubleshooting article](#).

STEP 9 Adding MMU2S settings to the PrusaSlicer

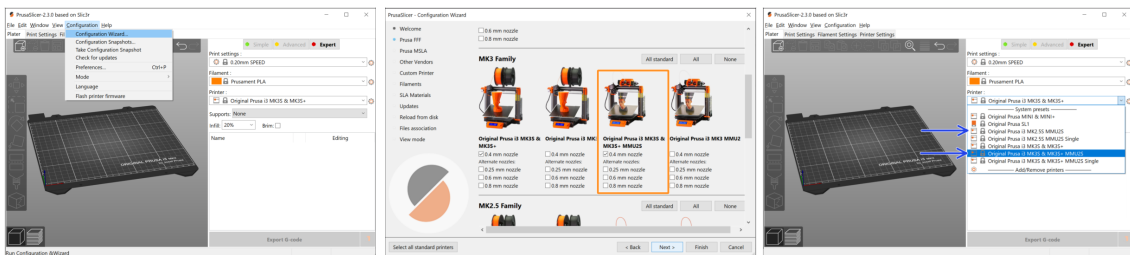

- ⚠️ Before you leave PrusaSlicer, please add the **MMU2S printer profiles!!!**
- ⚠️ **MMU2 and MMU2S G-codes aren't compatible!**
- 🟢 From the top menu select **Configuration -> Configuration Wizard**
- 🟠 Look for the MMU2S options and select your printer
- 🛡️ Click Next, then Finish
- 🟢 Expand the **Printer** menu and check if the MMU2S option is present. If not, please repeat the process again.

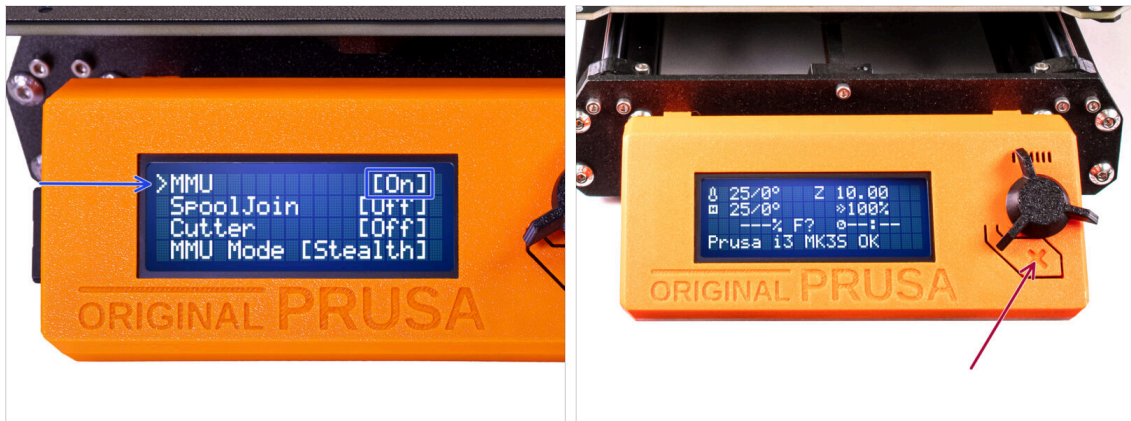
STEP 10 Turning the MMU on and reset

- ◆ After finishing the firmware update, **make sure there are no filaments loaded** neither in the extruder, or in the MMU unit.
- ⚠ If you are using firmware 3.0.0 and up, the MMU has to be turned on in the menu before use.
- ◆ Navigate to the **LCD menu > Settings > MMU**
- and make sure it is set to **MMU [On]**
- ◆ Hit the reset button on the printer's LCD box.
- ⚠ From now on, the reset button on the printer resets also the MMU unit. Wait for a while, the MMU unit will go through the self-test routine. (accompanied by flashing LED lights on the MMU unit) **Wait until it boots up properly**, before issuing any commands to the printer.

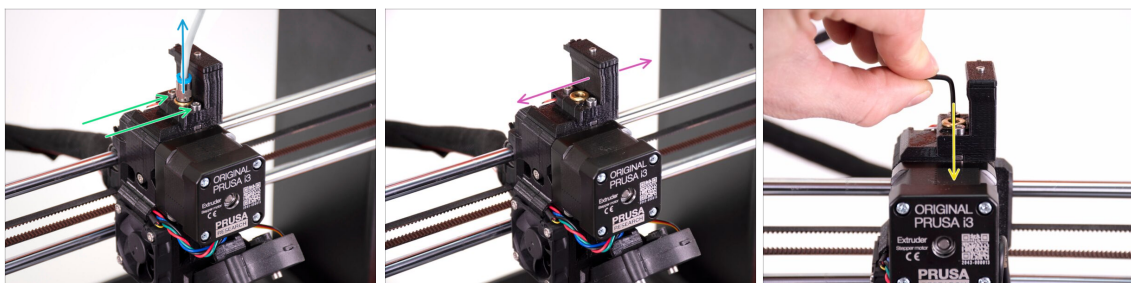
STEP 11 IR filament sensor calibration

- ◆ Release the PTFE tube from the extruder by unscrewing the fitting.
- ◆ Release the two screws holding the IR filament sensor chimney.
- ◆ Ensure the chimney can be moved left and right after releasing the two screws.
- ◆ Insert the 1.5mm Allen key into the extruder. Don't push it all the way in yet.

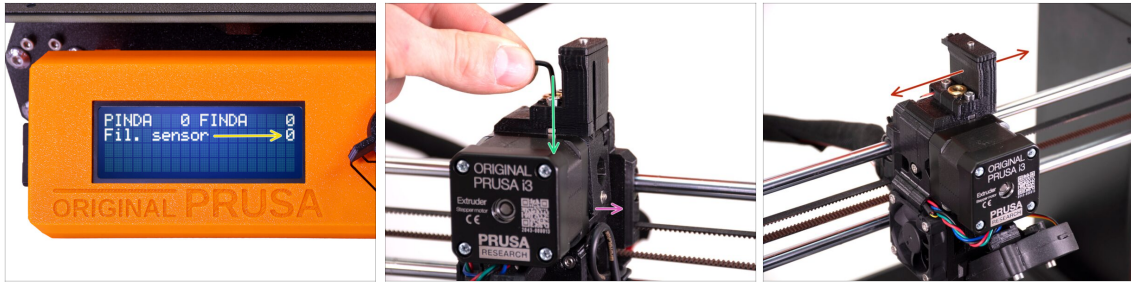
STEP 12 IR filament sensor calibration 2

- ◆ Go to **Menu -> Support -> Sensor Info -> Fil. sensor**
 The **Fil. sensor** should indicate value **0** when the Allen key isn't pushed all the way in so the idler door isn't tilted outwards.
- ◆ Now push the 1.5mm Allen key down until it reaches in between the Bondtech gears.
 - 📌 (don't be afraid to apply a fair amount of downwards force in order to get the key in between the gears)
- ◆ The idler door on the right of the extruder should tilt outwards slightly simulating an inserted filament.
- ⚠ **The Fil. sensor: line on the LCD should indicate value 1 with the Allen key (or a filament) inserted.**
- ◆ **Move the chimney left or right until the number on the LCD reliably changes accordingly when inserting and removing the Allen key from the Bontech gears in the extruder!**

STEP 13 IR filament sensor calibration 3

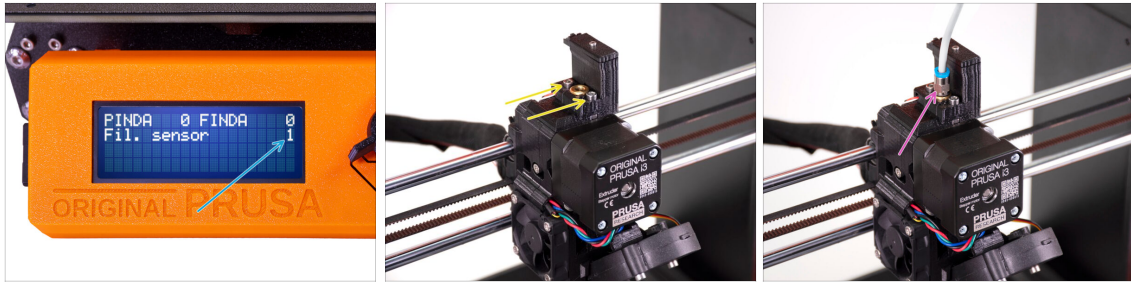

- ⚠ **Calibrating the IR filament sensor is super-crucial in order for MMU2S unit to work properly.**
- ⓘ Please, repeat this check several times.
- 🔵 Confirm the sensor works correctly: See the LCD again if the **Fil. sensor** number
 - ⬛ displays **1** when Allen key (/filament) is inserted all the way
 - ⬛ or **0** when it's not inserted all the way in.
- 🟡 When the sensor works reliably and correctly, please lock the chimney in place by tightening the two screws holding it with a 2.5mm Allen key.
- 🟣 Install the PTFE back onto the extruder by screwing the fitting in.
- ⓘ More info on filament IR-sensor calibration is in **Calibration procedure of the IR-sensor** article, or in chapter 7.1 in the Handbook.

STEP 14 SuperFINDA sensor calibration preparation

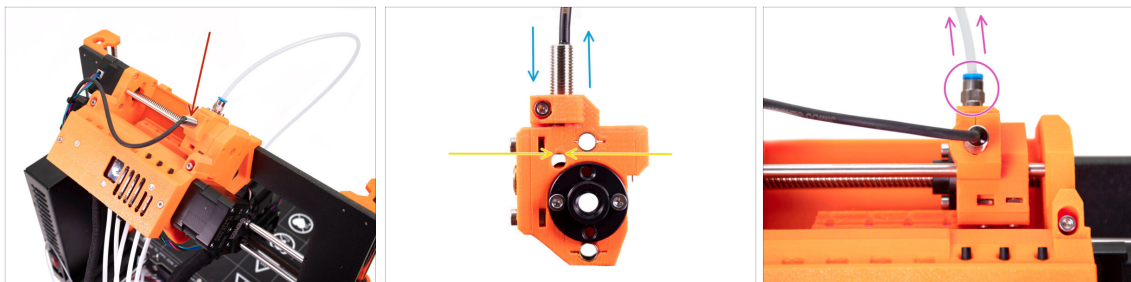

- 🟣 Congratulations, you have calibrated your IR filament sensor. Now we can move on to calibrating the SuperFINDA sensor inside the selector on the MMU2S.
- 🔵 In the next step, we will check if the sensor detects the filament correctly and adjust its position if needed.
- ⚠ **It is very important both IR filament sensor and SuperFINDA sensor work reliably and provide accurate readings.**
- 🟡 **The newest MMU2S unit revision** has inspection windows on the sides of the selector. It is a good starting point to line up the bottom of the SuperFINDA probe exactly with the top of the inspection window when looking from the selector motor side.
- 🟣 Start by releasing the PTFE tube from the MMU2S selector by unscrewing the fitting.

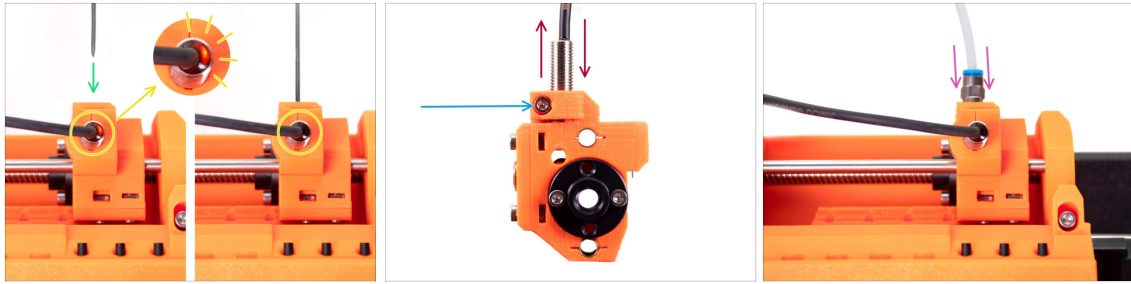
STEP 15 SuperFINDA calibration

- ◆ Take a piece of filament with a sharp tip and insert it into the selector, into the hole you have removed the PTFE tube with fitting from in the previous step.
- ◆ Take a look at the SuperFINDA probe from above and watch for the little red light inside the sensor go off when the filament raises the steel ball inside the selector.
- ◆ If the light is still on, lower the SuperFINDA slightly. If the light doesn't go on, raise the SuperFINDA probe by releasing the screw by its side, moving the probe, and tightening the probe up again.
- ⚠ **Repeat the test and adjust the SuperFINDA height accordingly until you have reliable readings from the probe each time you insert and remove filament.**
- i If you can't see the light from above the SuperFINDA, you can see the readings in Menu -> Support -> Sensor info -> FINDA.
- ◆ After you are done calibrating your SuperFINDA, fully tighten the screw holding the sensor in place.
- ◆ Attach the PTFE tube with fitting back onto the MMU2S unit.

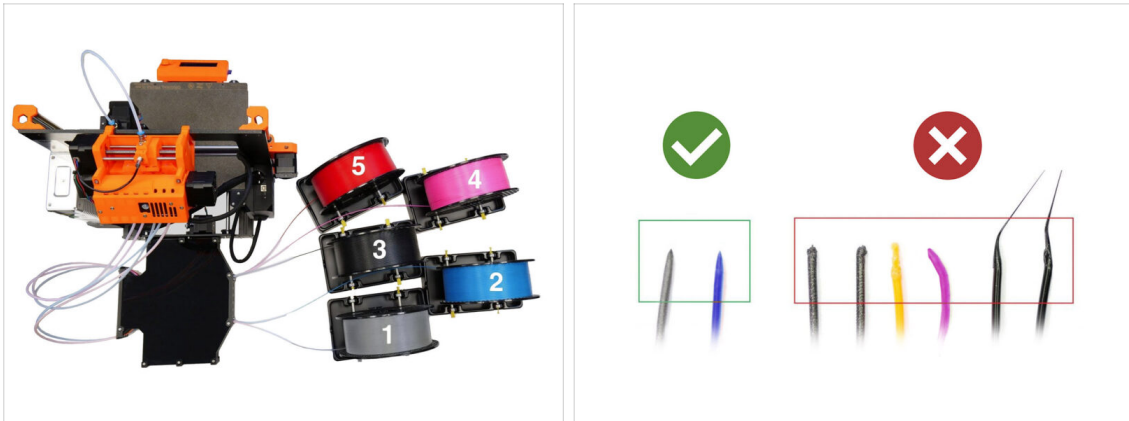
STEP 16 Preparing to load filaments for the test setup.

Congratulations! The hardest part is over. You have just successfully calibrated the sensors.

We can now move on to loading the filaments in and printing the test object!

- The setup in the first picture is the one we are trying to achieve.
- ⓘ Note the spool holder positioning. It is important so no filament gets stuck and nothing interferes.
- Please prepare at least two different PLA filaments and make sure they both have a sharp tip at the end, as seen in the picture.

STEP 17 Connecting the rear PTFE tubes

- Insert the PTFE from MMU2S unit to the buffer.
- Insert the M3x12 screw next to the PTFE and tighten it just so the PTFE doesn't come out. Don't over-tighten the screw. Excessive friction in the PTFE might cause issues during the printing later.
- Repeat the same for all the other PTFE tubes. You can organize the filament positions according to your preference.

STEP 18 Loading a filament into the buffer

- ◆ Insert filament into the buffer until it reaches out on the other side. Grab it using needle-nose pliers.
- ◆ Guide the filament into the PTFE tube leading to the first, leftmost position on the MMU2S unit.
- ◆ Load at least two different PLA filaments into positions 1 and 2.

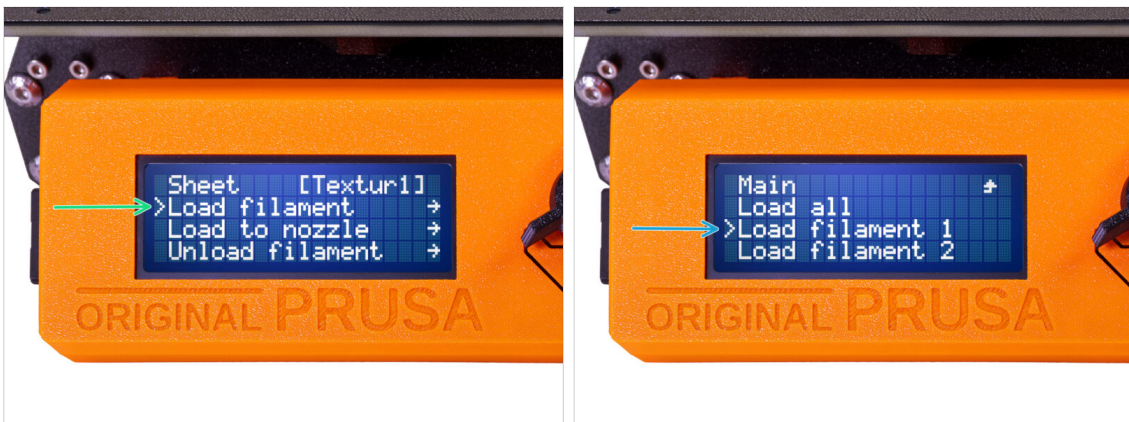
STEP 19 Loading a filament into MMU2S

- ◆ Go to the **Menu -> Load filament**.
- ◆ Select filament position, and insert the filament end into the corresponding rear PTFE tube until the MMU units start pulling the filament in. The filament must be straight and have a sharp tip.
- ⓘ Filament positions are labeled 1,2,3,4,5 from the left to right.
- ◆ Repeat for the second filament.

9. First flight



STEP 1 Z axis and first layer calibration (optional)

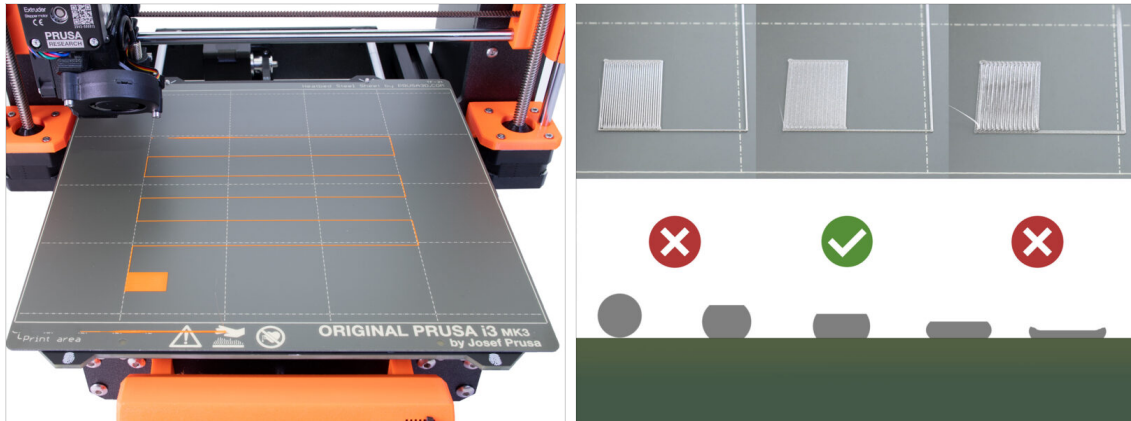

⚠ IMPORTANT: This step is necessary only in case you have adjusted the position of the SuperPINDA sensor in the previous chapter. Otherwise, you can skip to the next step and use the Live Adjust Z function as usual to fine-tune the first layer.

- Go to **LCD Menu - Calibration - Calibrate Z**.
- Then run the **First Layer Calibration**.

STEP 2 Loading a sample G-code to the printer

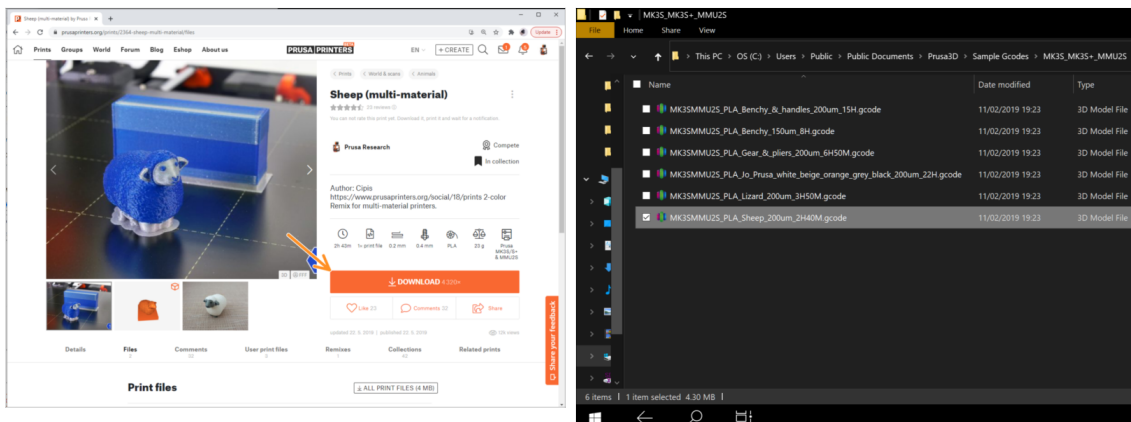

⚠ As a first print please print the Sheep, which is pre-sliced and tested. In case of any issues, it will make troubleshooting much easier.

- Visit our [PrusaPrinters.org](https://www.prusaprinters.org) profile to download a pre-sliced G-code for your printer.
- Or go to the folder **Prusa3D/Sample objects/MMU2(s)** via the link on your desktop. The link installs together with a full installation of the PrusaSlicer.
- load the **PLA_Sheep_200um G-code** to SD card and insert the card into your printer.

STEP 3 Start the print



- Start the print and wait until it is finished. In the meantime you can take a look in the printed Handbook (included in the package).
- If you are having any issues while printing, see our troubleshooting articles such as the [MMU needs user attention](#).

STEP 4 Handbook and Troubleshooting

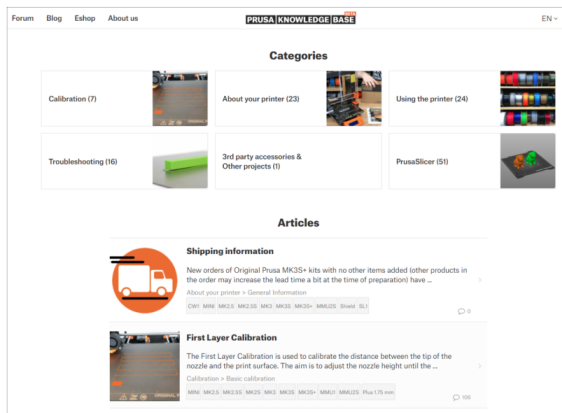
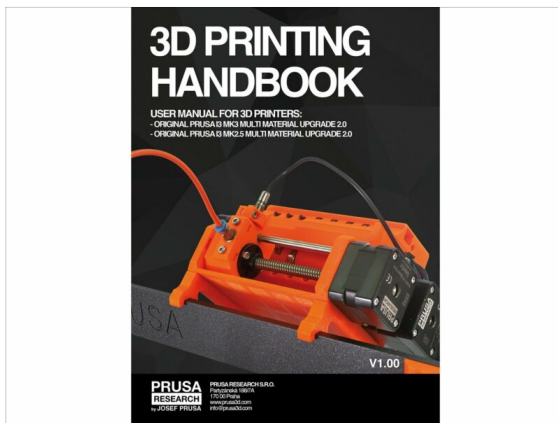

- All the information regarding calibration, how to organise the printer, buffer, spools, or troubleshooting tips are all in the printed or online Handbook. To download the Handbook or if you encounter any issues, please visit our knowledge base at: <http://help.prusa3d.com/en/tag/mmu2/>

STEP 5 Printable 3D models

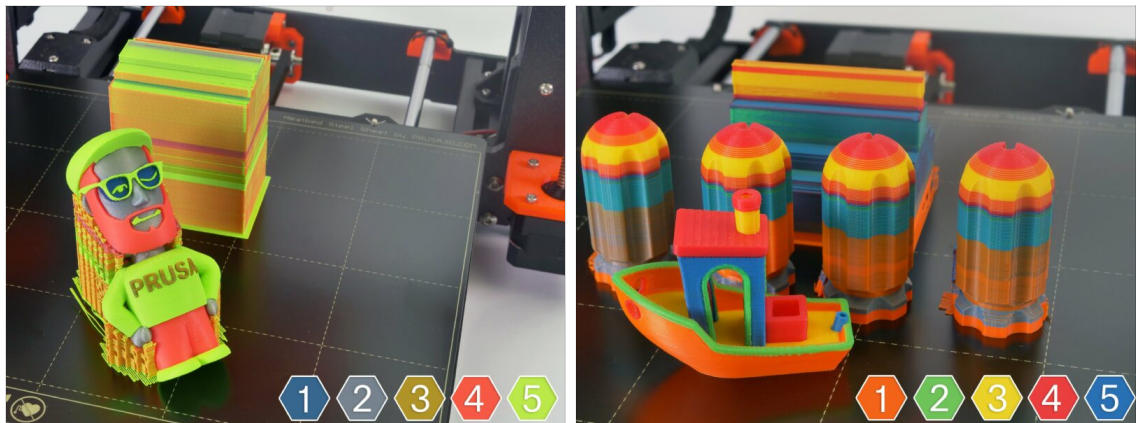

- You can start by printing some of our test objects that can be found at www.printables.com

STEP 6 G-code preparation / Custom model preparation

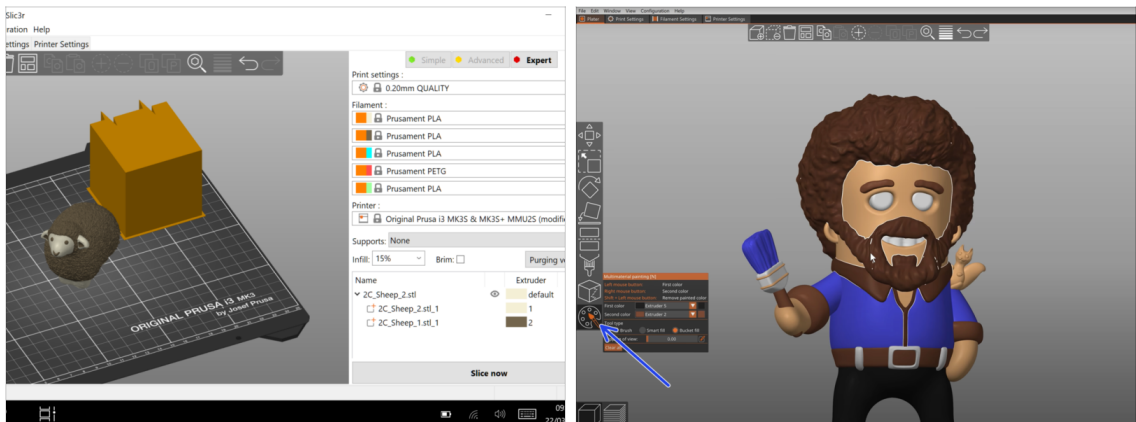

- Already printed all the bundled multi-material models from us and seen all the others from <http://PrusaPrinters.org>? Time to print your own designs!
- Basic steps are described in our [G-code preparation for multi material print](#) section.
- Definitely try out the [MMU Painting function](#) in PrusaSlicer for the models with a single body.

STEP 7 Making your own Multi-material models

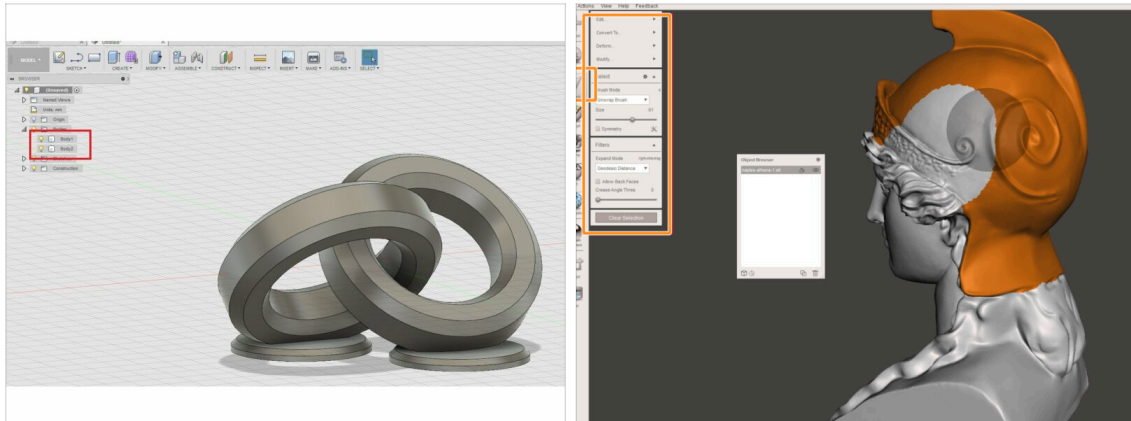

- ◆ If you have designed your own model, you may find [Exporting a model from Fusion 360](#) guide useful.
- ◆ If you have an STL file and want to print a large and complex part of it in a different color, then check [Splitting STL with single compact part](#) or the [Splitting STL using MeshMixer](#) guide.

STEP 8 Join PrusaPrinters!

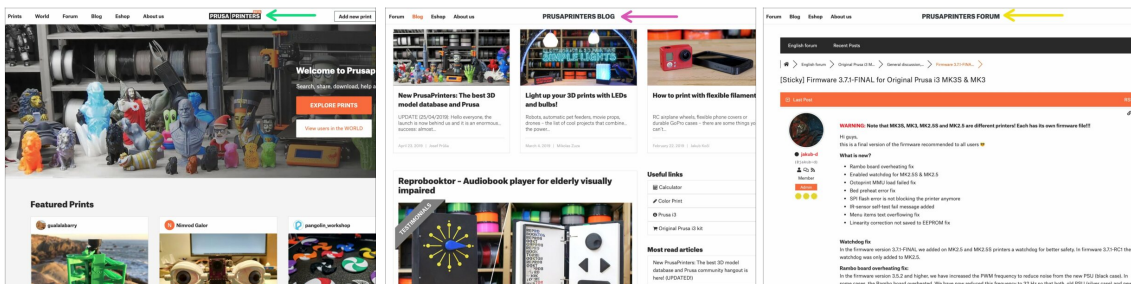

- ◆ Don't forget to join the biggest Prusa community! Download the latest models in STL or G-code tailored for your printer. Register at PrusaPrinters.org
- ◆ Looking for an inspiration on new projects? Check our blog with weekly updates.
- ◆ If you need help with the build, check out our forum with great community :-)
- ◆ All Prusa services share one account.

STEP 9 It finally is a Haribo time!

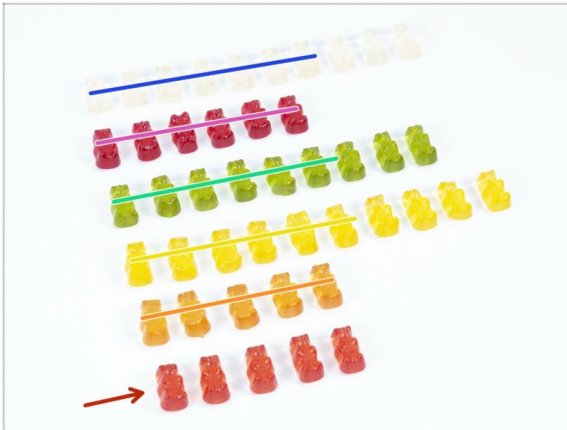

- ◆ **That's it, the assembly is over.**
- ◆ Eat the remaining bunch of bears.
- ◆ **We hope, you've enjoyed the build. Don't forget to leave feedback and see you in the next one :)**

Manual changelog MMU2S

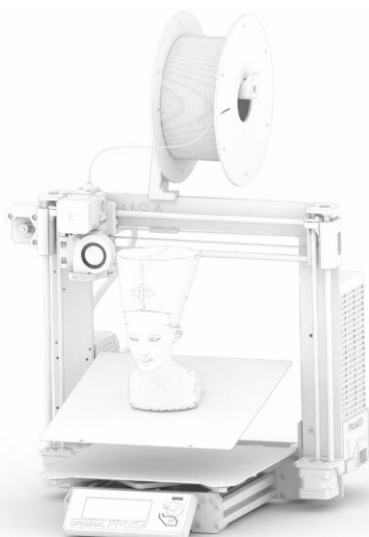

STEP 1 Versions history

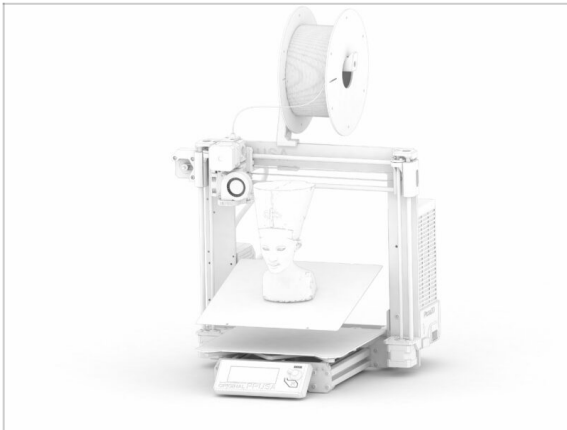

- ◆ **Versions of the MMU2S manual:**
 - ◆ 03/2019 - Initial version V1.00
 - ◆ 12/2020 - Update V1.01
 - ◆ 11/2021 - Update V1.02
- ⓘ Major changes for each version are described in the next steps.

STEP 2 Changes to the manual (1)

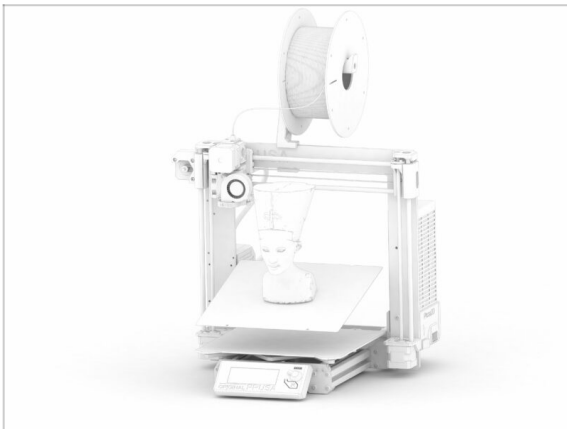

- ◆ 12/2020 - Original Prusa i3 MK3S+ additon
 - ◆ The assembly manual was extended with instructions for MK3S+.
- ◆ 11/2021 - New chapters added
 - ◆ Two chapters added, describing the initial calibration (nr. 8) and the first print (nr.9).







